

# HSDL-4270

High-Performance T-1 $\frac{3}{4}$  (5mm) AlGaAs Infrared (940nm) Lamp



## Datasheet

### Description

The HSDL-4270 Infrared emitter was designed for applications that require high power and low forward voltage. It utilizes Aluminum Gallium Arsenide (AlGaAs) LED technology and is optimized for efficiency at emission wavelengths of 940 nm. The material used produces high radiant efficiency over a wide range of currents. The emitter is packaged in clear T-1 $\frac{3}{4}$  (5mm) package.

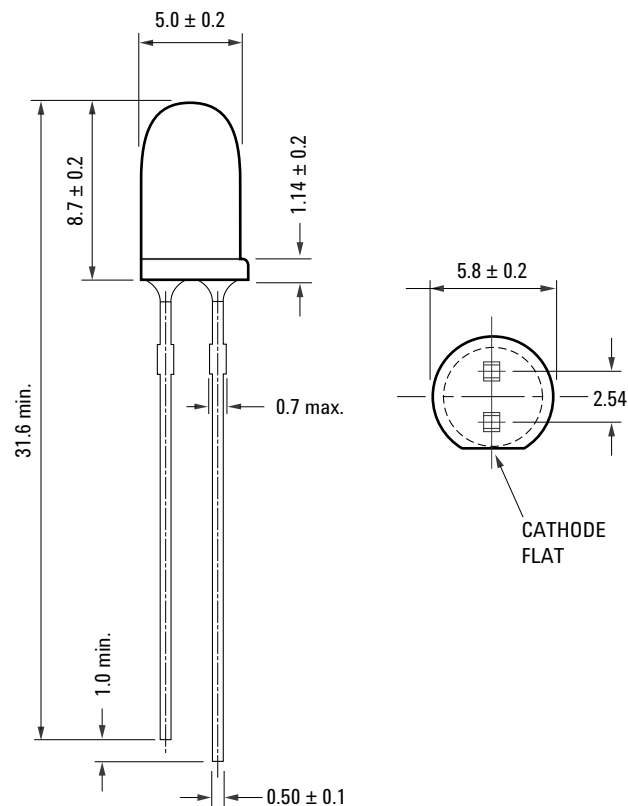

### Features

- High Power AlGaAs LED Technology
- 940 nm Wavelength
- T-1 $\frac{3}{4}$  Package
- Low Cost
- Low Forward Voltage: 1.3V at 20mA

### Applications

- Industrial Infrared Equipments and Applications (Smoke Detectors etc)
- Consumer Electronics (Infrared Remote Controller etc)
- Infrared spotlight for cameras
- Discrete Interrupters
- Infrared source for optical counters and card readers

Part Number	Lead Form	Shipping Option
HSDL-4270	Straight	Bulk

### Absolute Maximum Ratings at 25°C

Parameter	Symbol	Minimum	Maximum	Unit	Reference
Peak Forward Current	$I_{FPK}$	-	500	mA	Figure 3 Duty cycle = 20% Pulse Width = 100us
Forward Current	$I_{FDC}$	-	100	mA	[1]
Power Dissipation	$P_{DISS}$	-	170	mW	
Reverse Voltage	$V_R$	5	-	V	$I_R=100\mu A$
Storage Temperature	$T_S$	-40	100	°C	
LED Junction Temperature	$T_J$		110	°C	
Lead Soldering Temperature			260 for 5 sec	°C	

Notes:

1. Derate as shown in Figure 6.

### Recommended Operating Conditions

Parameter	Symbol	Min	Max	Unit	Reference
Operating Temperature	$T_0$	-40	85	°C	

### Electrical Characteristics at 25°C

Parameter	Symbol	Min.	Typ.	Max.	Unit	Condition	Reference
Forward Voltage	$V_F$	-	1.3 1.5	1.4 1.7	V	$I_{FDC}=20mA$ $I_{FDC}=100mA$	Figure 2 Figure 3
Forward Voltage Temperature Coefficient	$\Delta V/\Delta T$	-	-1.4	-	mV/°C	$I_{FDC}=100mA$	Figure 4
Series Resistance	$R_S$	-	3.0	-	Ohms	$I_{FDC}=100mA$	
Diode Capacitance	$C_0$	-	27	-	pF	$V_{bias}=0V$ , $f=1MHz$	
Thermal Resistance, Junction to Ambient	$R\theta_{ja}$	-	300	-	°C/W		

### Optical Characteristics at 25°C

Parameter	Symbol	Min.	Typ.	Max.	Unit	Condition	Reference
Radiant On-Axis Intensity	$I_E$	76	100	-	mW/Sr	$I_{FDC}=100mA$	Figure 5
Radiant On-Axis Intensity Temperature Coefficient	$\Delta I_E/\Delta T$	-	-0.48	-	%/°C	$I_{FDC}=100mA$	
Viewing Angle	$2\theta_{1/2}$	-	15	-	°		Figure 7
Peak Wavelength	$\lambda_{pk}$	-	940	-	nm		Figure 1
Peak wavelength Temperature Coefficient	$\Delta \lambda/\Delta T$	-	0.26	-	nm/°C	$I_{FDC}=100mA$	
Spectral Width	$\Delta \lambda$		45	-	nm	$I_{FDC}=20mA$	Figure 1
Optical Rise and Fall Time	$t_r/t_f$		1.3	-	μs	$I_{FDC}=100mA$ Duty Ratio = 50% Pulse Width=10μs	

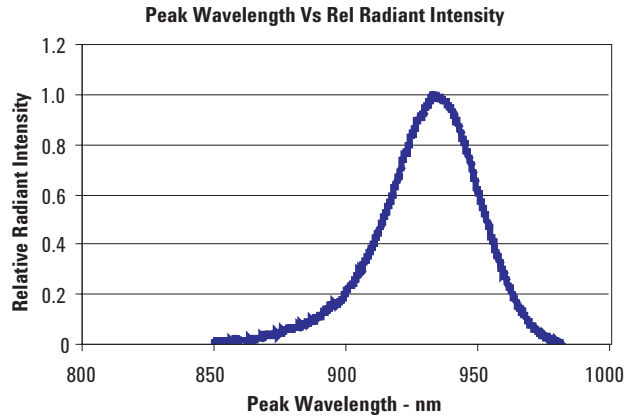

Figure 1. Relative Radiant Intensity vs. Wavelength

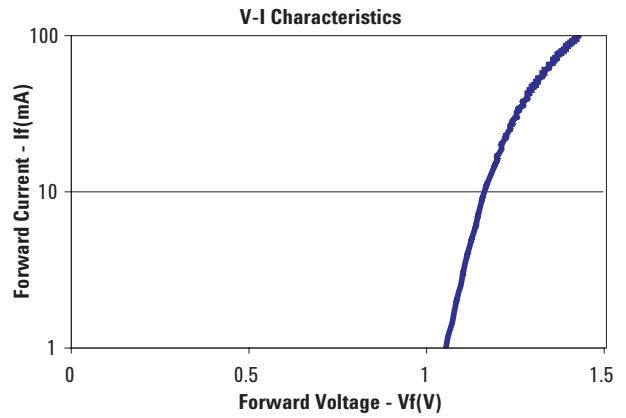

Figure 2. DC Forward Current vs. Forward Voltage

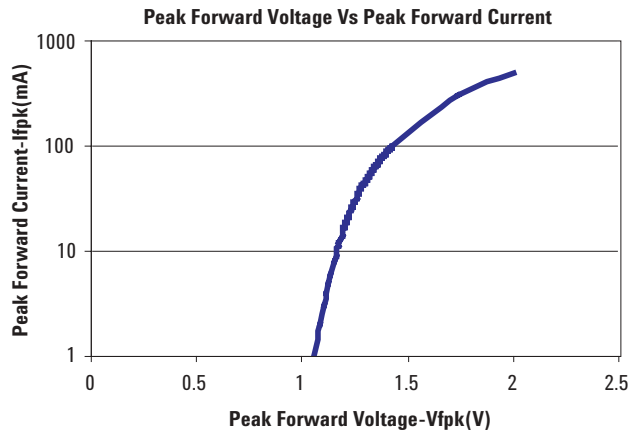

Figure 3. Peak Forward Current vs. Forward Voltage

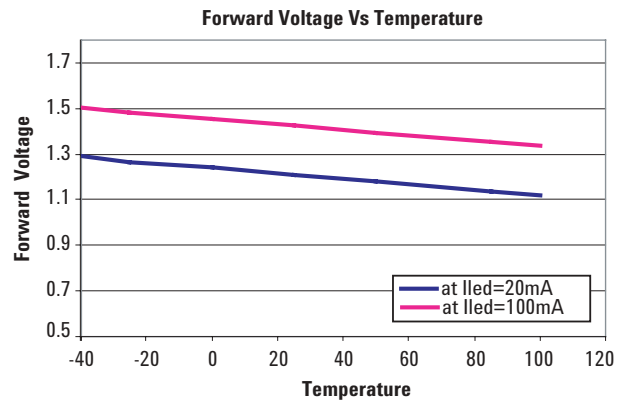

Figure 4. Forward Voltage vs. Ambient Temperature

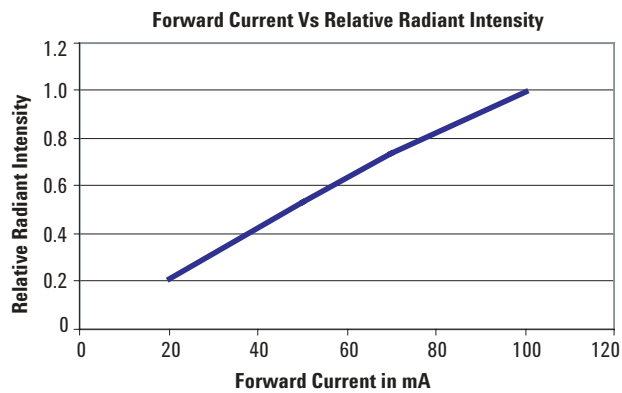

Figure 5. Relative Radiant Intensity vs. DC Forward Current

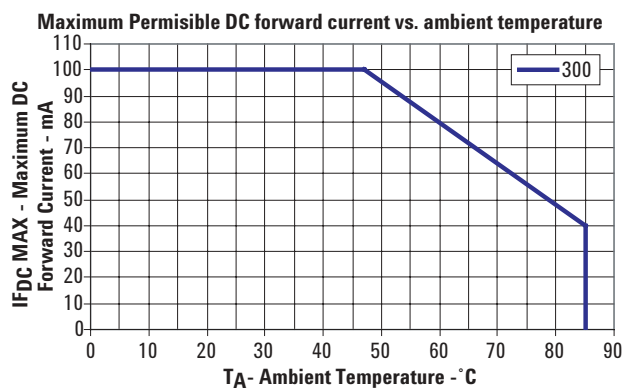
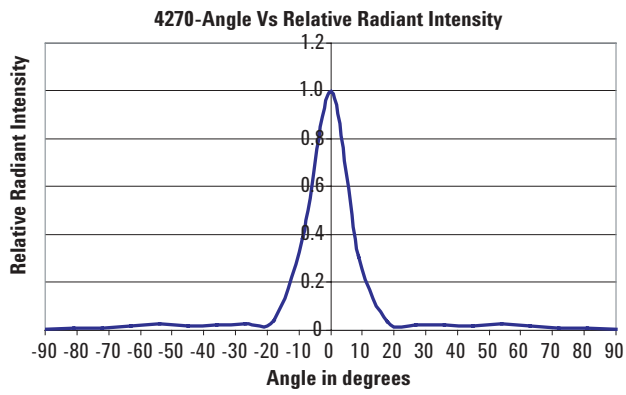
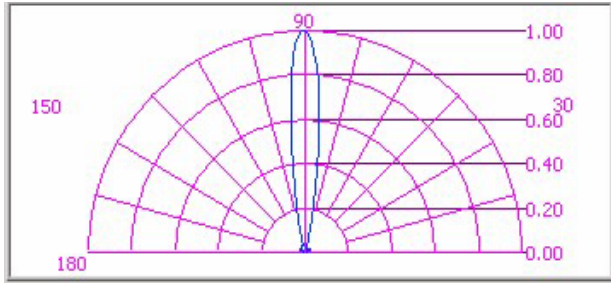

Figure 6. DC Forward Current vs. Ambient Temperature Derated Based on  $T_{JMAX}=110^{\circ}C$



**Figure 7. Radiant Intensity vs. Angular Displacement**

For company and product information, please go to our web site: [WWW.liteon.com](http://WWW.liteon.com) or <http://optodatabook.liteon.com/databook/databook.aspx>

Data subject to change. Copyright © 2007 Lite-On Technology Corporation. All rights reserved.

