

IGBT Gate Driver + DC/DC Converter

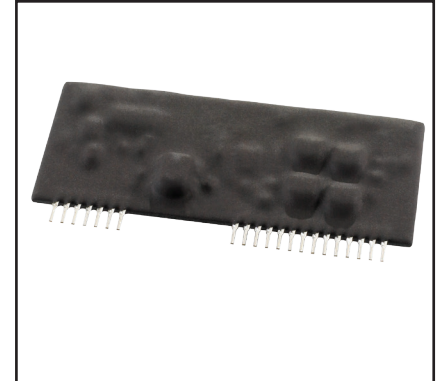
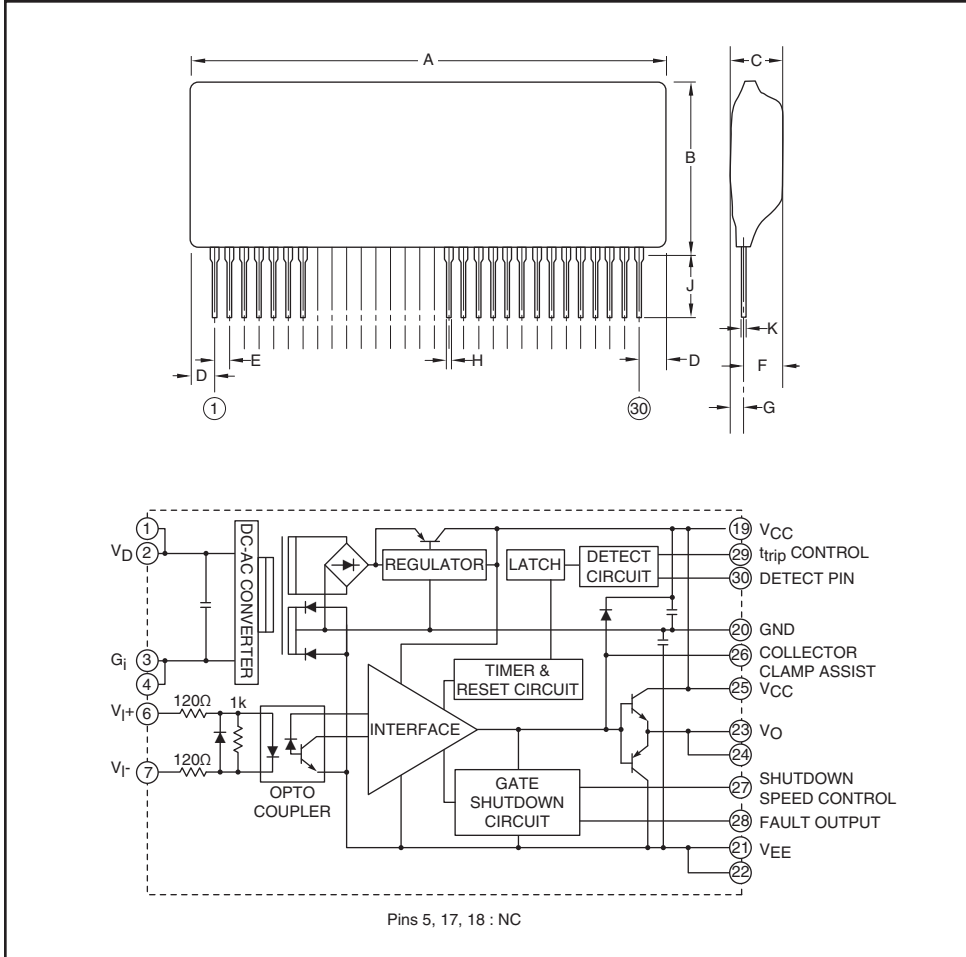

Description:

VLA552-01R is a hybrid integrated circuit designed for driving n-channel IGBT modules in any gate-amplifier application. This device is a fully isolated gate drive circuit consisting of an optically isolated gate drive amplifier and an isolated DC-DC converter. The gate driver provides an over-current protection function based on desaturation detection.

Features:

- Built in Isolated DC-DC Converter for Gate Drive
- SIP Outline Allows More Space
- Built in Short Circuit Protection with a pin for Fault Output
- Built in Collector Clamp Circuit
- Variable Fall Time on Short-Circuit Protection
- Electrical Isolation Voltage 4000 V_{rms} (for 1 Minute)
- CMOS Compatible Input Interface

Applications:

- To Drive IGBT Modules for General Industrial Use.

Recommended IGBT Modules:

V_{CES} = 1200V Series up to 3600A Class

V_{CES} = 1700V Series up to 3600A Class

Circuit Diagram

Dimensions	Inches	Millimeters
A	3.46 Max.	88.0 Max.
B	1.67 Max.	42.5 Max.
C	0.67 Max.	17.0 Max.
D	0.31 Max.	8.0 Max.
E	0.1	2.54
F	0.45 Max.	11.5 Max.
G	0.24 Max.	6.0 Max.
H	0.03±0.004	0.75±0.1
J	0.14±0.04	3.5±1.0
K	0.028 Max.	0.7 Max.

VLA552-01
IGBT Gate Driver + DC/DC Converter
Absolute Maximum Ratings, $T_a = 25^\circ\text{C}$ unless otherwise specified

Characteristics	Symbol	Rating	Units
Supply Voltage (DC)	V_D	-1 ~ 16.5	Volts
Input Signal Voltage (Applied Between Pins 6-7, 50% Duty Cycle, Pulse Width 1ms)	V_I	-7 ~ +7	Volts
Output Peak Current (Pulse Width 3 μ s)	I_{OHP}	-24	Amperes
	I_{OLP}	24	Amperes
Isolation Voltage (Sine Wave Voltage 60Hz, for 1 min., R.H. <60%)	V_{iso}	4000	V_{rms}
Case Temperature (Surface Temperature)	T_C	100	$^\circ\text{C}$
Operating Temperature (No Condensation Allowable)	T_{opr}	-25 ~ 70	$^\circ\text{C}$
Storage Temperature (No Condensation Allowable)	T_{stg}	-40 ~ 100 ^{*1}	$^\circ\text{C}$
Fault Output Current (Applied at Pin 28)	I_{FO}	20	mA
Input Voltage to Pin 30 (Applied at Pin 30)	V_{R30}	60	Volts
Gate Drive Current (Gate Average Current)	I_{drive}	210 ^{*2}	mA

Electrical Characteristics, $T_a = 25^\circ\text{C}$, $V_D = 15\text{V}$, $R_G = 1\Omega$, $C_L = 1.6\mu\text{F}$, $f = 3\text{kHz}$ unless otherwise specified

Characteristics	Symbol	Test Conditions	Min.	Typ.	Max.	Units
Supply Voltage	V_D	Recommended Range	14.2	15	15.8	Volts
Pull-up Voltage on Input Side	V_{IN}	Recommended Range	4.75	5	5.25	Volts
Input Signal Current	I_{IH}	Recommended Range	10	12	16	mA
Switching Frequency	f	Recommended Range	—	—	10	kHz
Gate Resistance	R_G	Recommended Range	0.33	—	—	Ω
Input Signal Current	I_{IH}	$V_{IN} = 5\text{V}$, HCMOS Drive	—	12	—	mA
Gate Positive Supply Voltage	V_{CC}		15.2	16.5	17.5	Volts
Gate Negative Supply Voltage	V_{EE}		-6	-8	-11.5	Volts
Gate Supply Efficiency	η	Load Current = 210mA, $E_{ta} = (V_{CC} + V_{EE}) \times 0.21 / (15 \times I_D) \times 100$	60	72	—	%
"H" Output Voltage	V_{OH}	10k Ω Connected Between Pins 23-20	14	15.3	16.5	Volts
"L" Output Voltage	V_{OL}	10k Ω Connected Between Pins 23-20	-5.5	-7	-11	Volts
"L-H" Propagation Time	t_{PLH}	$I_{IH} = 12\text{mA}$	0.3	—	1	μs
"L-H" Rise Time	t_r	$I_{IH} = 12\text{mA}$	—	0.6	1.2	μs
"H-L" Propagation Time	t_{PHL}	$I_{IH} = 12\text{mA}$	0.3	—	1	μs
"H-L" Fall Time	t_f	$I_{IH} = 12\text{mA}$	—	0.3	1.2	μs
Timer	t_{timer}	Between Start and Cancel (Under Input Sign "OFF")	1	—	2	ms
Fault Output Current	I_{FO}	Applied Pin 28, $R = 4.7\text{k}\Omega$	—	5	—	mA
Controlled Time Detect Short Circuit 1	t_{trip1}	Pin 30: 15V and more, Pin 29: Open	—	3.5	—	μs
Controlled Time Detect Short Circuit 2 ^{*3}	t_{trip2}	Pin 30: 15V and more, Pins 29-21, 22: 10pF (Connective Capacitance)	—	3.9	—	μs
SC Detect Voltage	V_{SC}	Collector Voltage of IGBT	15	—	—	Volts

*1 Differs from H/C condition.

*2 Refer to I_{drive} - T_a characteristics.

*3 Length of wiring of condenser controlled time detect short-circuit is within 5cm from Pins 21, 22 and 29 coming and going.

VLA552-01R
IGBT Gate Driver + DC/DC Converter

Definition of Characteristics

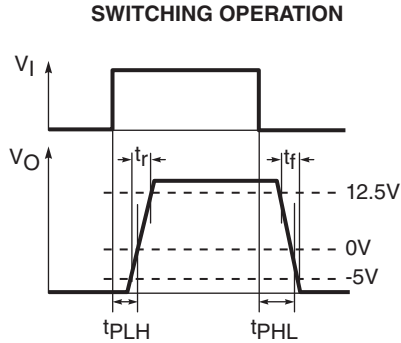

OPERATION OF SHORT CIRCUIT PROTECTION

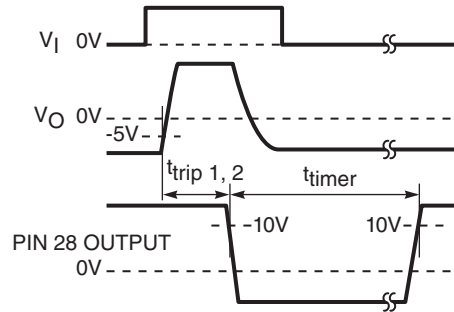

Application Example

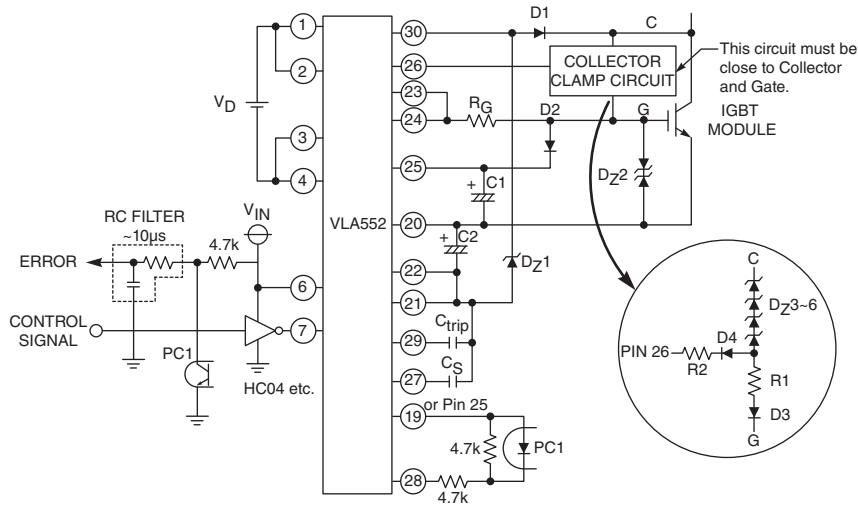

$V_D = 15V \pm 5\%$
 $V_{LN} = 5V \pm 5\%$
 PC1 : TLP781 (TOSHIBA) etc.
 C_{trip} : Depends on R_G
 C_S : Depends on Surge Voltage
 D_{Z1} : 30V, 0.5W~1W
 D_{Z2} : 18V, Bidirectional
 D_1 : Fast Recovery Diode (t_{rr} : 200ns max.)
 RP1H (SanKen) etc.
 C_1, C_2 : 470 μ F, 35V (Low Impedance)

V_{2-4} : SBD $V_{RM} = 60V, I_{FSM} > 60A$ Class
 R_1 : 1 Ω , 1W Class
 R_2 : 10 Ω , 1/4W Class
 D_{Z3-6} : $V_{pn} < \text{Total } V_Z < V_{CES}$ of IGBT
 Rough guide of total V_Z is as follows:
 For V_{CES} 1200V Series \rightarrow 900~1000V
 For V_{CES} 1700V Series \rightarrow 1300~1400V
 It depends on $V_{pn}, I_{C(max)}, R_G$, snubber
 circuit inductance of power main circuit, and
 kind of main condenser.

NOTE:

- Decoupling capacitors should be located as close as possible to the Hybrid IC pins.
- The gate circuit path should be kept as short as possible to minimize influence of switching noise.
- D_1 requires approximately the same blocking voltage as the IGBT modules.
- When recovery current flows in D_1 , Pin 30 sees high voltage. A zener diode between Pin 21 and Pin 30 is necessary as shown in above diagram.
- If the short-circuit protection circuit is not used, please connect a 4.7k ohm resistor between Pin 30 and pin 20. (D_1 and D_{Z1} are not required.)
- If the collector clamp circuit is activated repeatedly, it may be destroyed as a result of overheating. For this reason, power dissipation of the zener diode should be determined by testing in the actual inverter.

VLA552-01
IGBT Gate Driver + DC/DC Converter

Operation of Protection Circuit

1. When an "ON" input signal is applied for a period longer than T_{trip} and the collector voltage is high, the hybrid IC will recognize the condition as a short-circuit and immediately reduce the gate voltage. It will also produce a low voltage fault signal at the respective Pin 29 or Pin 16 alerting that the protection circuit is in operation.
2. The protection circuit will reset if an "OFF" input signal is applied and the minimum 1~2ms shutdown time has passed. "OFF" signal must be 10 μ s or more.
3. The controlled time to detect a short-circuit (T_{trip}) should be set so that the IGBT can be fully turned "ON" before a short-circuit condition can be detected. It is possible to adjust T_{trip} by connecting a capacitor (C_{trip}) between Pins 18 and 21, as well as Pins 27 and 24.
4. When the short-circuit protection is activated, the soft gate shutdown circuit reduces the collector surge voltage on the IGBT. The gate shut down speed can be slowed even more by adding a capacitor to the CS terminal (between Pins 15 and 18; Pins 27 and 30).

Adjustment of Output Fall Time

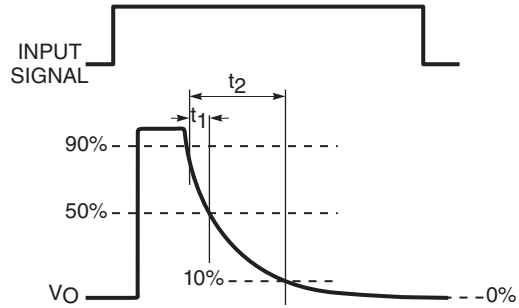

Operation Flow on Detecting Short Circuit

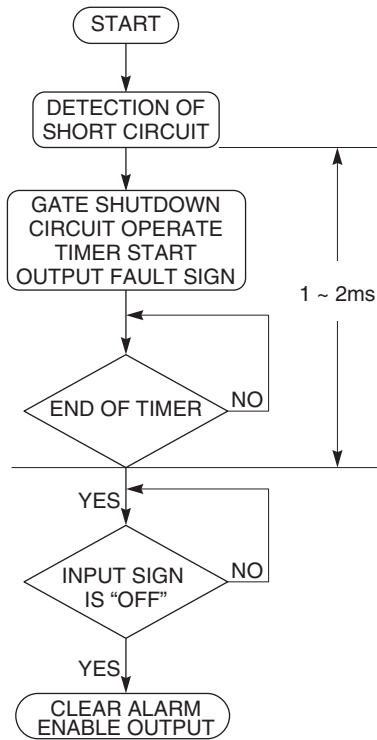

NOTE: Output voltage with protection circuit operating is about $-|V_{EE}| + 2V$

t_1, t_2 vs C_S CHARACTERISTICS (TYPICAL)

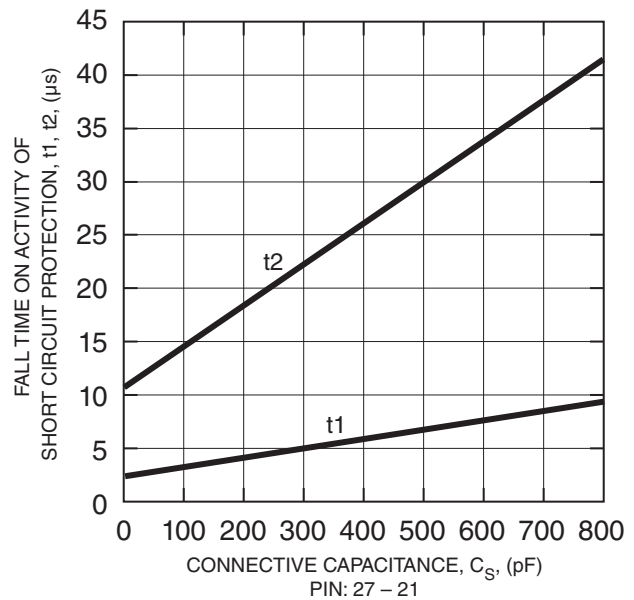

VLA552-01R
IGBT Gate Driver + DC/DC Converter

V_{CC} , V_{EE} | T_a CHARACTERISTICS
(TYPICAL)

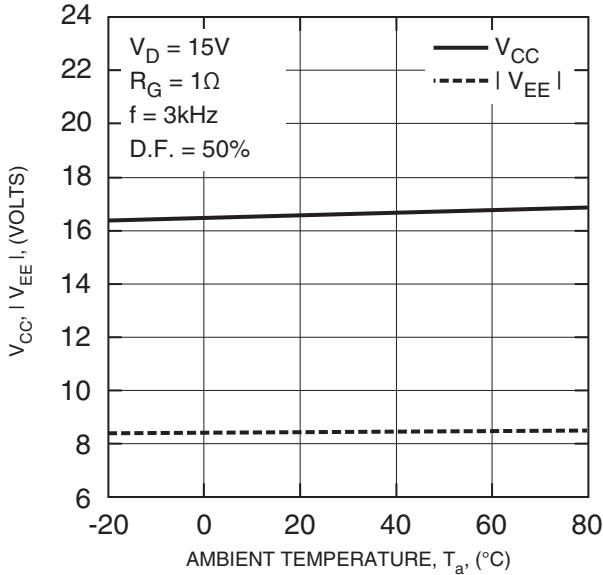

V_{CC} , V_{EE} | I_O CHARACTERISTICS
(TYPICAL)

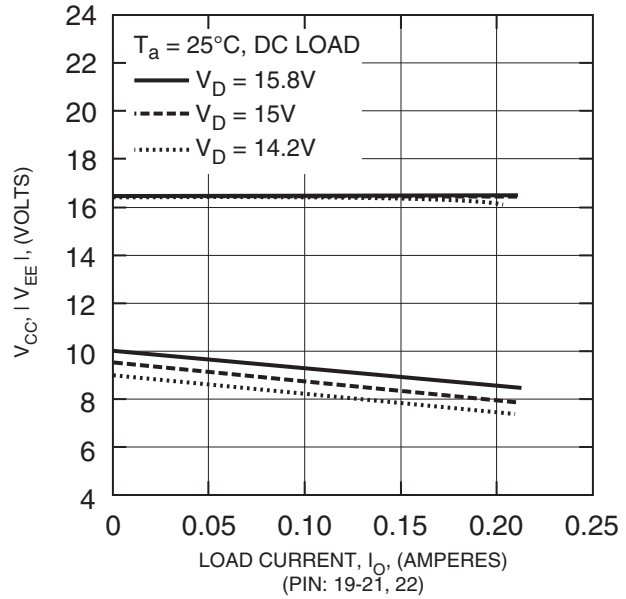

t_{PLH} , t_{PHL} - T_a CHARACTERISTICS
(TYPICAL)

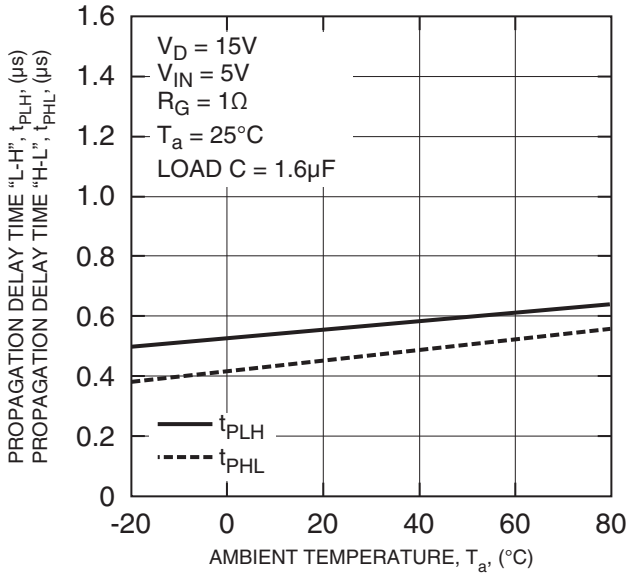

t_{PLH} , t_{PHL} - V_I CHARACTERISTICS
(TYPICAL)

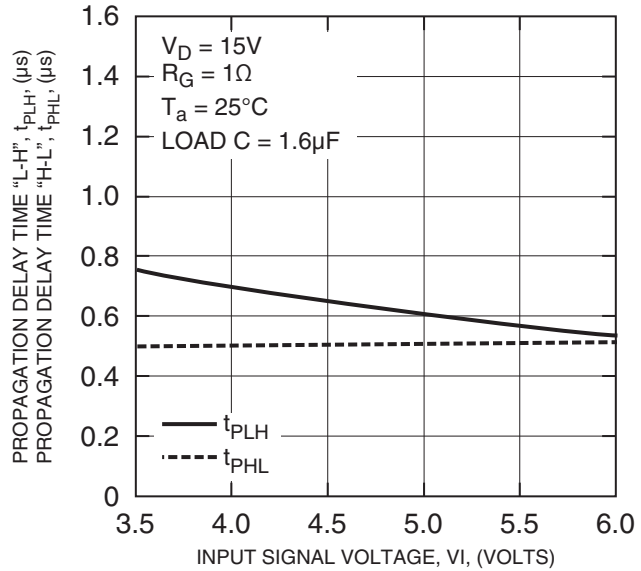

VLA552-01
IGBT Gate Driver + DC/DC Converter

**t_{trip} - T_a CHARACTERISTICS
(TYPICAL)**

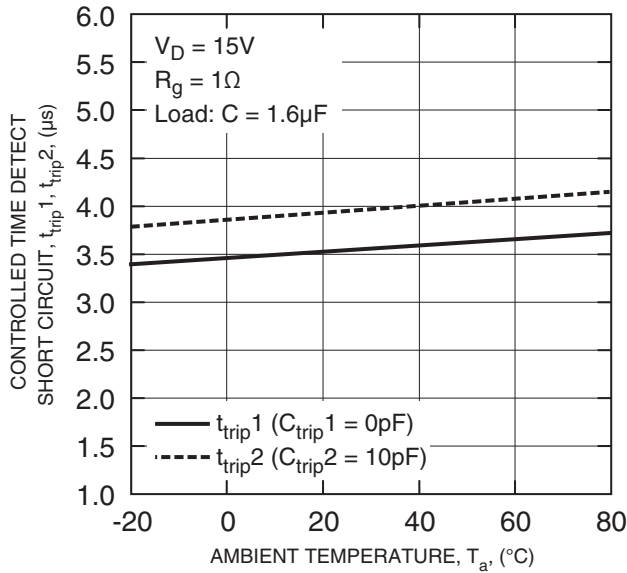

**t_{trip} - C_{trip} CHARACTERISTICS
(TYPICAL)**

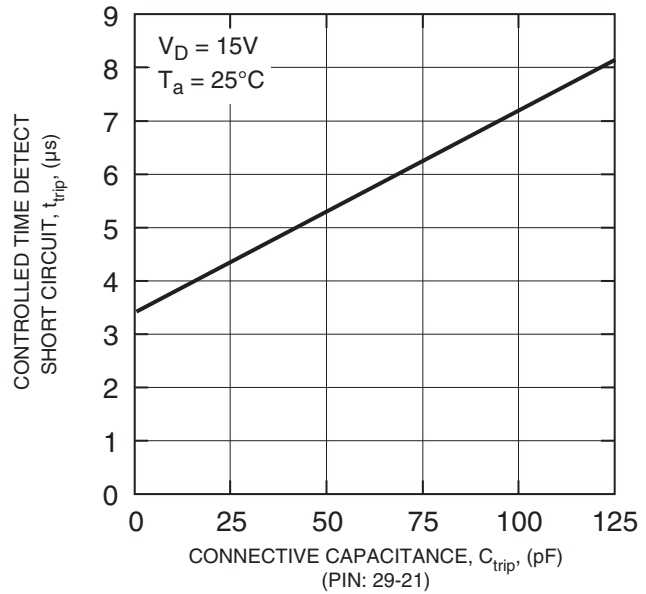

**I_D - I_O CHARACTERISTICS
(TYPICAL)**

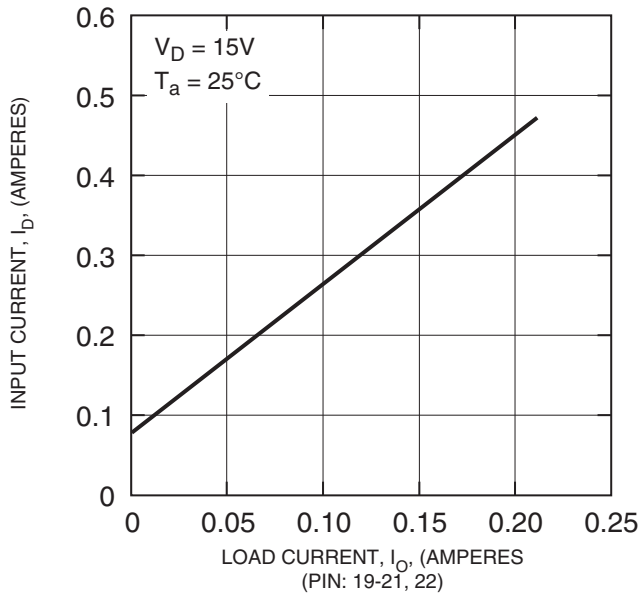

**V_{OH} , V_{OL} - T_a CHARACTERISTICS
(TYPICAL)**

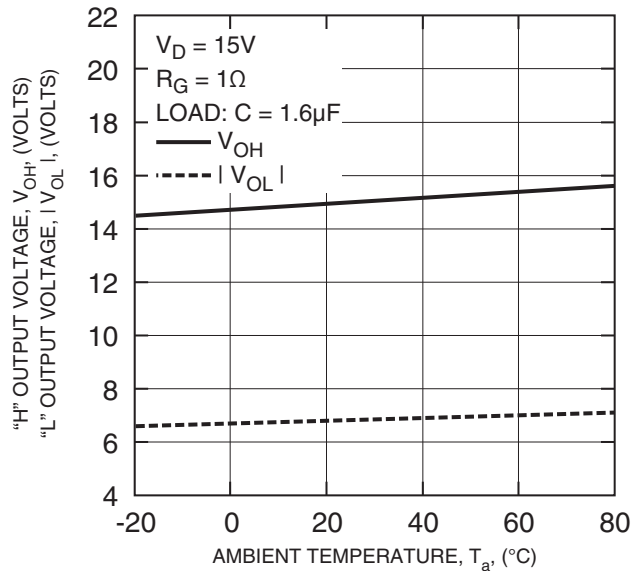

VLA552-01R
IGBT Gate Driver + DC/DC Converter

η - I_{drive} CHARACTERISTICS
(TYPICAL)

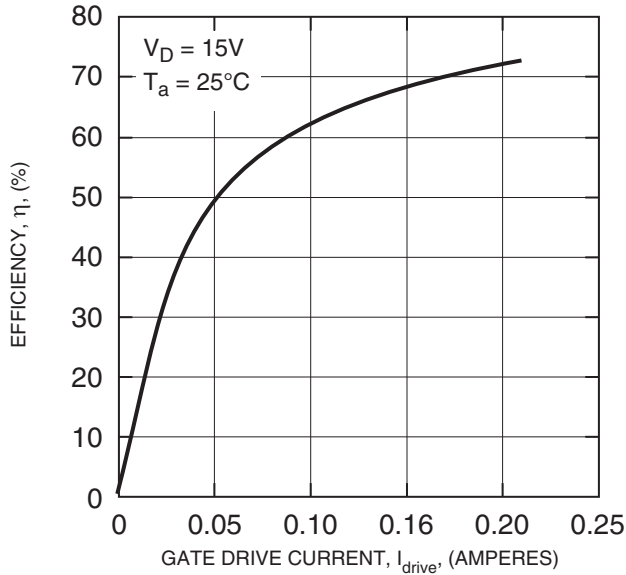

V_{CC} , $|V_{EE}|$ - V_D CHARACTERISTICS
(TYPICAL)

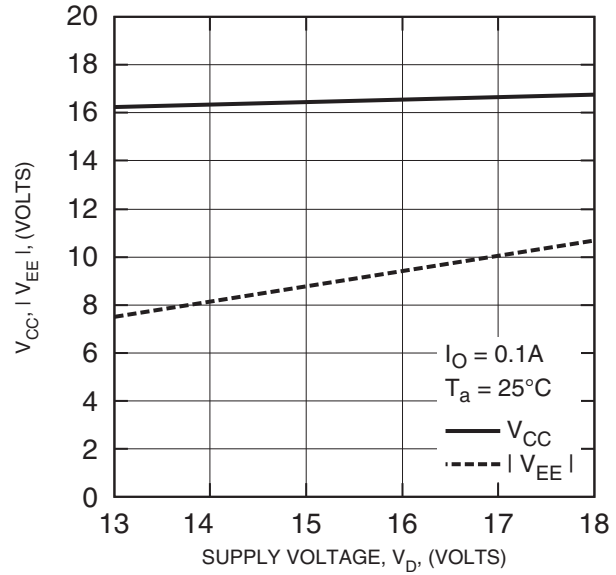

I_{drive} - T_a CHARACTERISTICS
(TYPICAL)

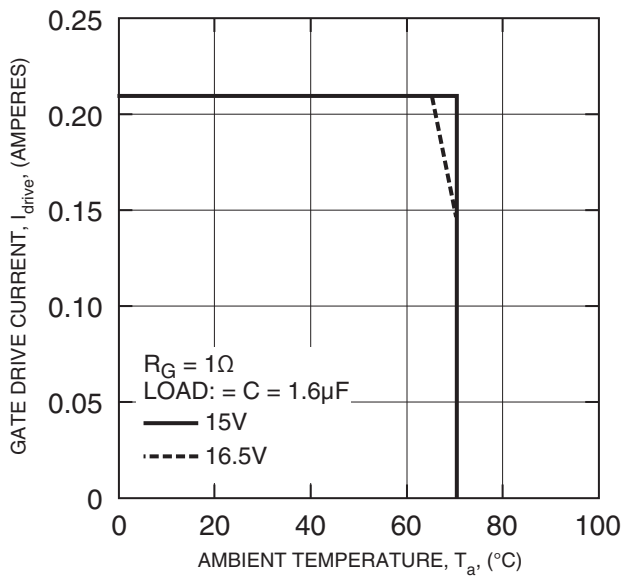

η - V_D CHARACTERISTICS
(TYPICAL)

