

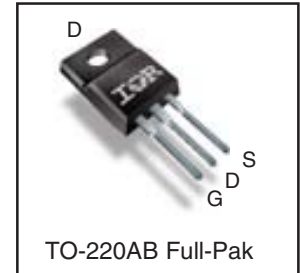
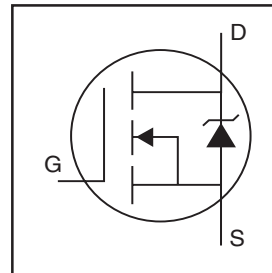
**PDP SWITCH**

**IRFI4229PbF**

**Features**

- Advanced Process Technology
- Key Parameters Optimized for PDP Sustain, Energy Recovery and Pass Switch Applications
- Low  $E_{PULSE}$  Rating to Reduce Power Dissipation in PDP Sustain, Energy Recovery and Pass Switch Applications
- Low  $Q_G$  for Fast Response
- High Repetitive Peak Current Capability for Reliable Operation
- Short Fall & Rise Times for Fast Switching
- 150°C Operating Junction Temperature for Improved Ruggedness
- Repetitive Avalanche Capability for Robustness and Reliability

Key Parameters		
$V_{DS}$ max	250	V
$V_{DS}$ (Avalanche) typ.	300	V
$R_{DS(ON)}$ typ. @ 10V	38	mΩ
$I_{RP}$ max @ $T_C = 100^\circ\text{C}$	32	A
$T_J$ max	150	°C



G	D	S
Gate	Drain	Source

**Description**

This HEXFET® Power MOSFET is specifically designed for Sustain; Energy Recovery & Pass switch applications in Plasma Display Panels. This MOSFET utilizes the latest processing techniques to achieve low on-resistance per silicon area and low  $E_{PULSE}$  rating. Additional features of this MOSFET are 150°C operating junction temperature and high repetitive peak current capability. These features combine to make this MOSFET a highly efficient, robust and reliable device for PDP driving applications.

**Absolute Maximum Ratings**

	Parameter	Max.	Units
$V_{GS}$	Gate-to-Source Voltage	±30	V
$I_D$ @ $T_C = 25^\circ\text{C}$	Continuous Drain Current, $V_{GS}$ @ 10V	19	A
$I_D$ @ $T_C = 100^\circ\text{C}$	Continuous Drain Current, $V_{GS}$ @ 10V	12	
$I_{DM}$	Pulsed Drain Current ①	72	
$I_{RP}$ @ $T_C = 100^\circ\text{C}$	Repetitive Peak Current ⑤	32	
$P_D$ @ $T_C = 25^\circ\text{C}$	Power Dissipation	46	W
$P_D$ @ $T_C = 100^\circ\text{C}$	Power Dissipation	18	
	Linear Derating Factor	0.37	W/°C
$T_J$ $T_{STG}$	Operating Junction and Storage Temperature Range	-40 to + 150	°C
	Soldering Temperature for 10 seconds	300	
	Mounting Torque, 6-32 or M3 Screw	10lb·in (1.1N·m)	

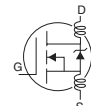
**Thermal Resistance**

	Parameter	Typ.	Max.	Units
$R_{\theta JC}$	Junction-to-Case ④	—	2.73	°C/W
$R_{\theta JA}$	Junction-to-Ambient ④	—	65	

Notes ① through ⑤ are on page 8

## Electrical Characteristics @ $T_J = 25^\circ\text{C}$ (unless otherwise specified)

	Parameter	Min.	Typ.	Max.	Units	Conditions
$BV_{DSS}$	Drain-to-Source Breakdown Voltage	250	—	—	V	$V_{GS} = 0V, I_D = 250\mu A$
$\Delta BV_{DSS}/\Delta T_J$	Breakdown Voltage Temp. Coefficient	—	340	—	mV/°C	Reference to $25^\circ\text{C}, I_D = 1mA$
$R_{DS(on)}$	Static Drain-to-Source On-Resistance	—	38	46	mΩ	$V_{GS} = 10V, I_D = 11A$ ③
$V_{GS(th)}$	Gate Threshold Voltage	3.0	—	5.0	V	$V_{DS} = V_{GS}, I_D = 250\mu A$
$\Delta V_{GS(th)}/\Delta T_J$	Gate Threshold Voltage Coefficient	—	-12	—	mV/°C	
$I_{DSS}$	Drain-to-Source Leakage Current	—	—	20	μA	$V_{DS} = 250V, V_{GS} = 0V$
		—	—	200		$V_{DS} = 250V, V_{GS} = 0V, T_J = 125^\circ\text{C}$
$I_{GSS}$	Gate-to-Source Forward Leakage	—	—	100	nA	$V_{GS} = 20V$
	Gate-to-Source Reverse Leakage	—	—	-100		$V_{GS} = -20V$
$g_{fs}$	Forward Transconductance	26	—	—	S	$V_{DS} = 25V, I_D = 11A$
$Q_g$	Total Gate Charge	—	73	110	nC	$V_{DD} = 125V, I_D = 11A, V_{GS} = 10V$ ③
$Q_{gd}$	Gate-to-Drain Charge	—	24	—		
$t_{d(on)}$	Turn-On Delay Time	—	18	—	ns	$V_{DD} = 125V, V_{GS} = 10V$ ③ $I_D = 11A$ $R_G = 2.4\Omega$ See Fig. 22
$t_r$	Rise Time	—	17	—		
$t_{d(off)}$	Turn-Off Delay Time	—	32	—		
$t_f$	Fall Time	—	13	—		
$t_{st}$	Shoot Through Blocking Time	100	—	—	ns	$V_{DD} = 200V, V_{GS} = 15V, R_G = 5.1\Omega$
$E_{PULSE}$	Energy per Pulse	—	770	—	μJ	$L = 220nH, C = 0.3\mu F, V_{GS} = 15V$ $V_{DS} = 200V, R_G = 5.1\Omega, T_J = 25^\circ\text{C}$
		—	1380	—		$L = 220nH, C = 0.3\mu F, V_{GS} = 15V$ $V_{DS} = 200V, R_G = 5.1\Omega, T_J = 100^\circ\text{C}$
$C_{iss}$	Input Capacitance	—	4480	—	pF	$V_{GS} = 0V$
$C_{oss}$	Output Capacitance	—	400	—		$V_{DS} = 25V$
$C_{riss}$	Reverse Transfer Capacitance	—	100	—		$f = 1.0MHz,$
$C_{oss\ eff.}$	Effective Output Capacitance	—	270	—		$V_{GS} = 0V, V_{DS} = 0V \text{ to } 200V$
$L_D$	Internal Drain Inductance	—	4.5	—	nH	Between lead, 6mm (0.25in.) from package and center of die contact
$L_S$	Internal Source Inductance	—	7.5	—		

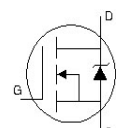


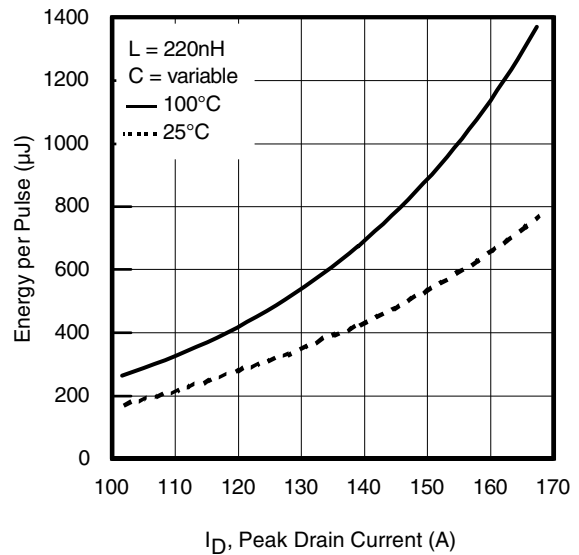
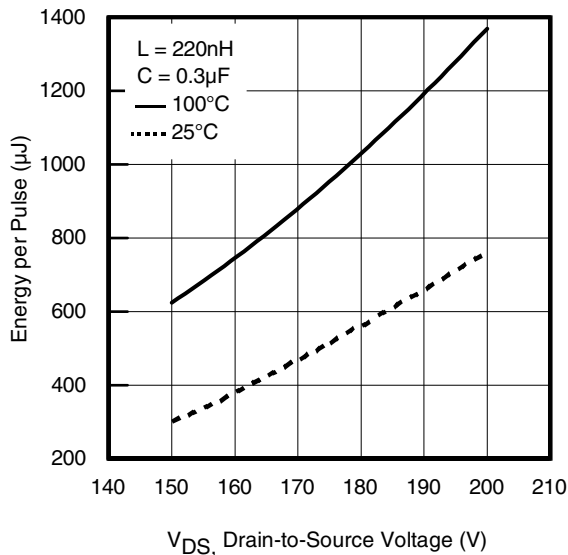
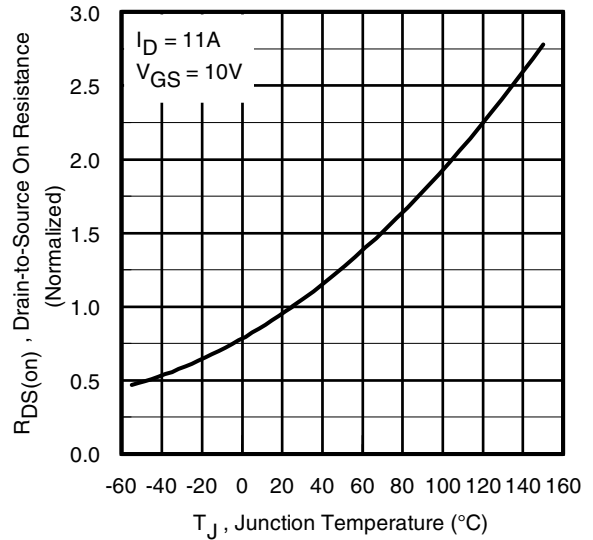
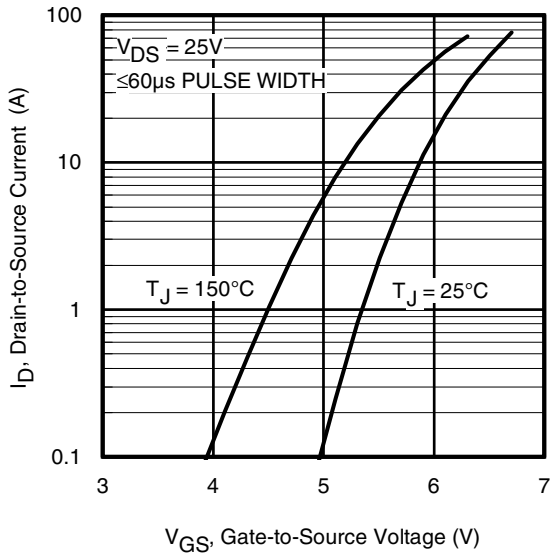
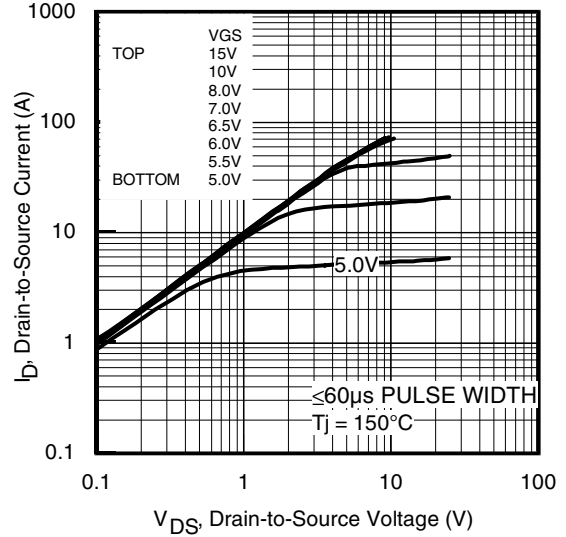
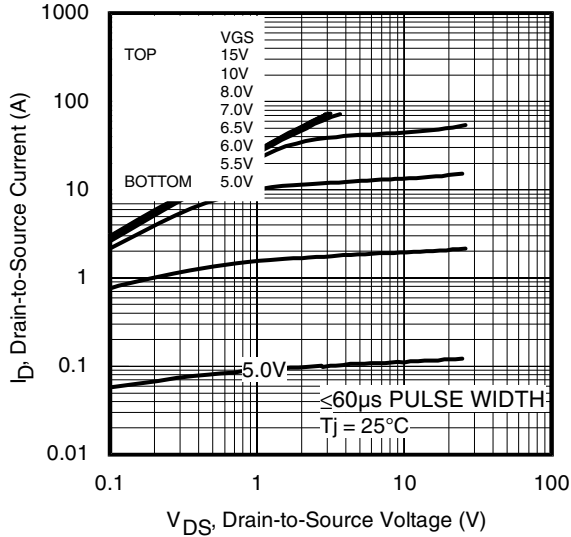
## Avalanche Characteristics

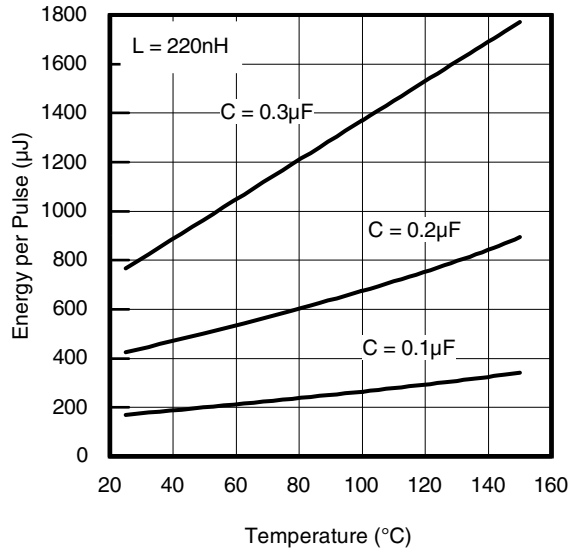
	Parameter	Typ.	Max.	Units
$E_{AS}$	Single Pulse Avalanche Energy ②	—	110	mJ
$E_{AR}$	Repetitive Avalanche Energy ①	—	4.6	mJ
$V_{DS(Avalanche)}$	Repetitive Avalanche Voltage ①	300	—	V
$I_{AS}$	Avalanche Current ②	—	11	A

## Diode Characteristics

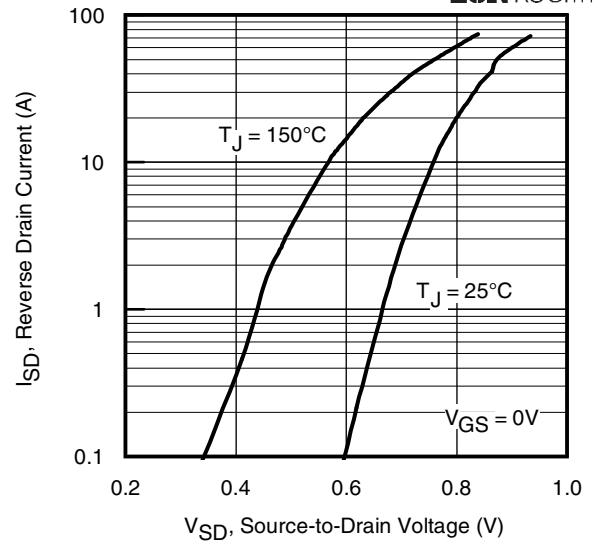
	Parameter	Min.	Typ.	Max.	Units	Conditions
$I_S @ T_C = 25^\circ\text{C}$	Continuous Source Current (Body Diode)	—	—	18	A	MOSFET symbol showing the integral reverse p-n junction diode.
$I_{SM}$	Pulsed Source Current (Body Diode) ①	—	—	72		
$V_{SD}$	Diode Forward Voltage	—	—	1.3	V	$T_J = 25^\circ\text{C}, I_S = 11A, V_{GS} = 0V$ ③
$t_{rr}$	Reverse Recovery Time	—	120	180	ns	$T_J = 25^\circ\text{C}, I_F = 11A, V_{DD} = 50V$
$Q_{rr}$	Reverse Recovery Charge	—	540	810	nC	$di/dt = 100A/\mu s$ ③



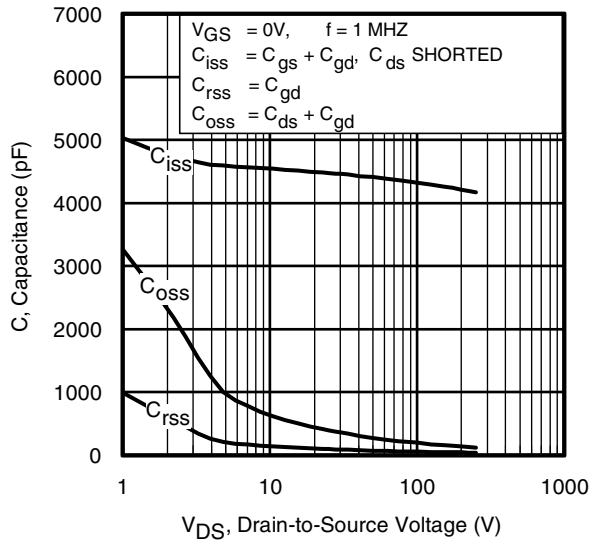




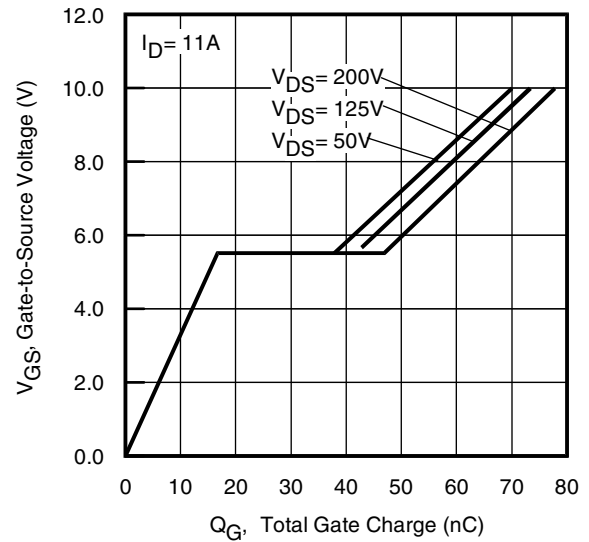
**Fig 7.** Typical  $E_{PULSE}$  vs. Temperature



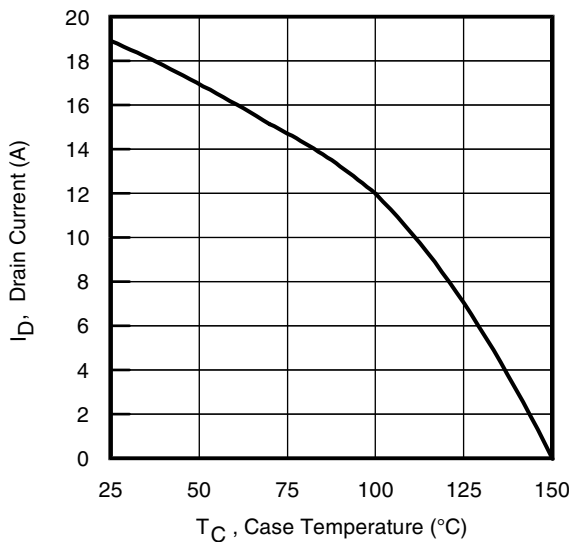
**Fig 8.** Typical Source-Drain Diode Forward Voltage



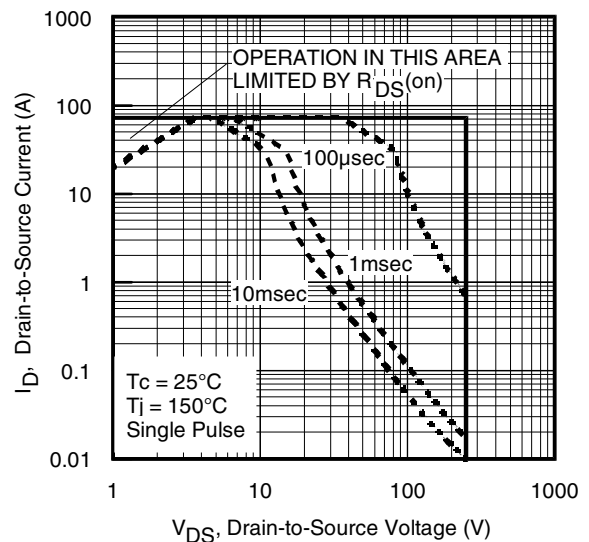
**Fig 9.** Typical Capacitance vs. Drain-to-Source Voltage



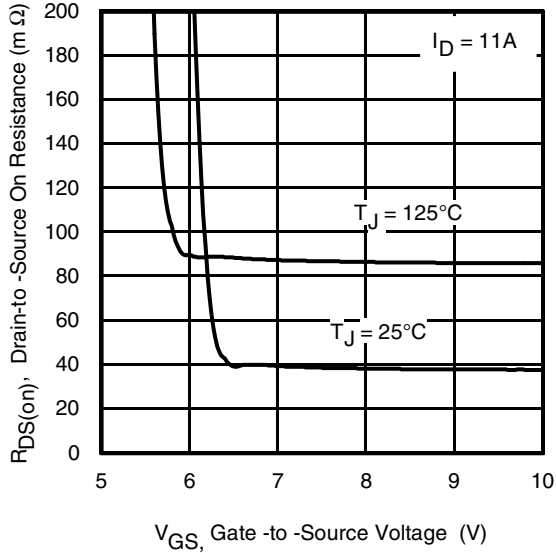
**Fig 10.** Typical Gate Charge vs. Gate-to-Source Voltage



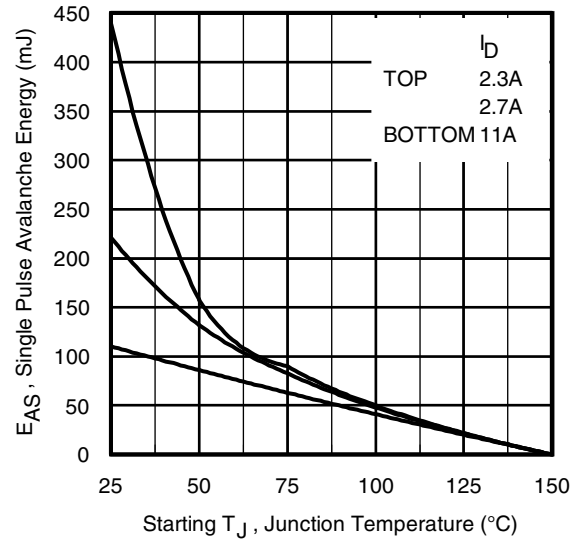
**Fig 11.** Maximum Drain Current vs. Case Temperature



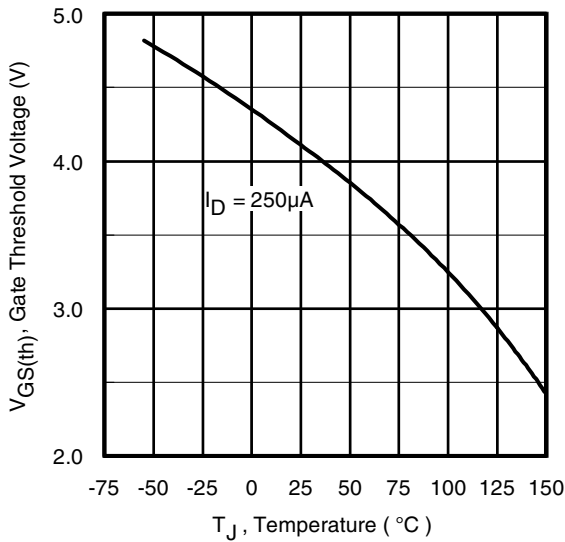
**Fig 12.** Maximum Safe Operating Area



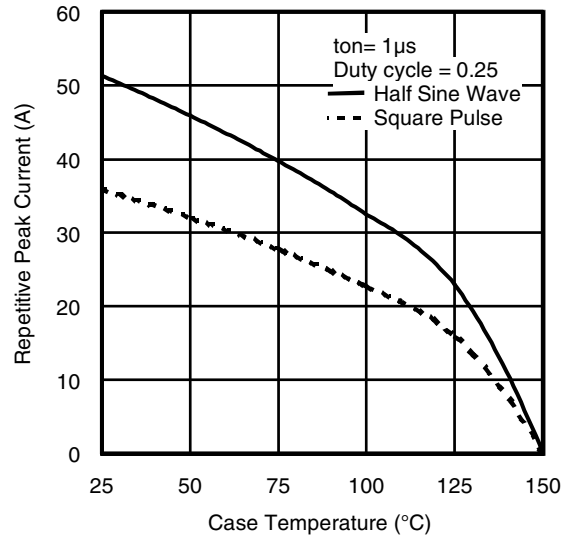
**Fig 13.** On-Resistance vs. Gate Voltage



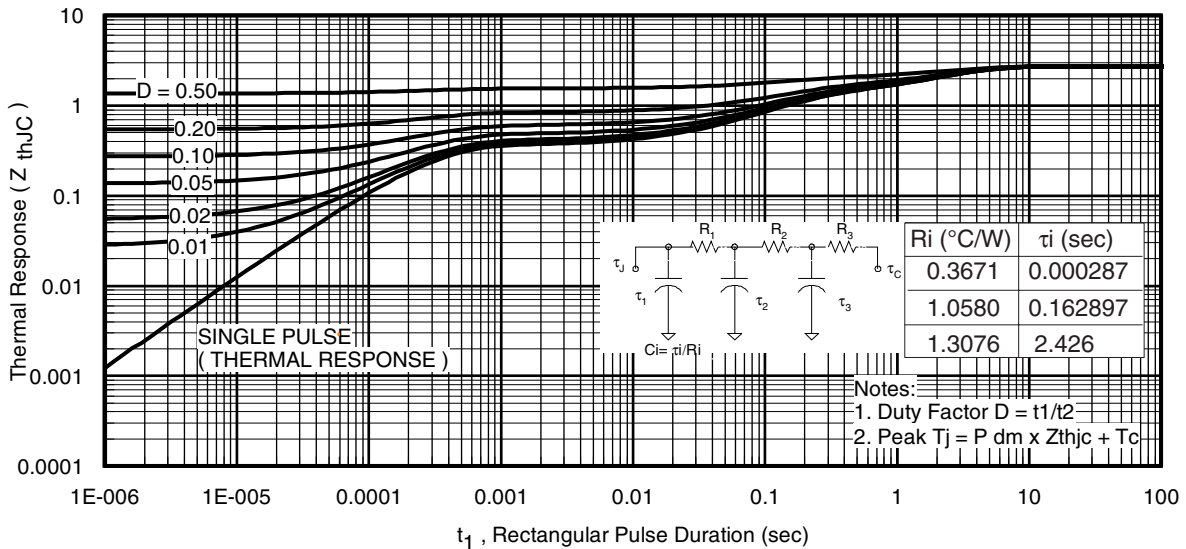
**Fig 14.** Maximum Avalanche Energy vs. Temperature



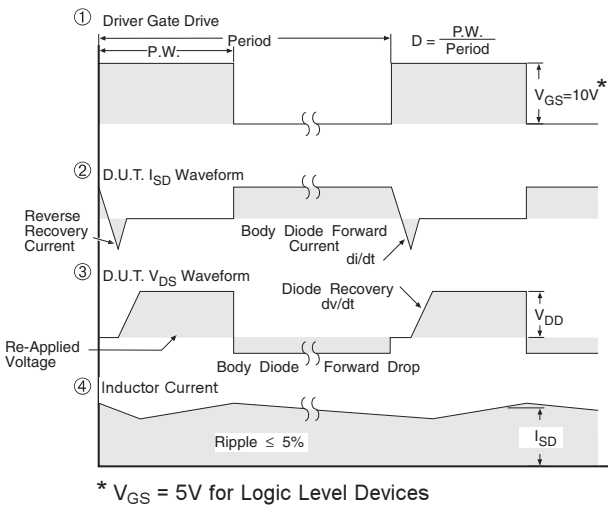
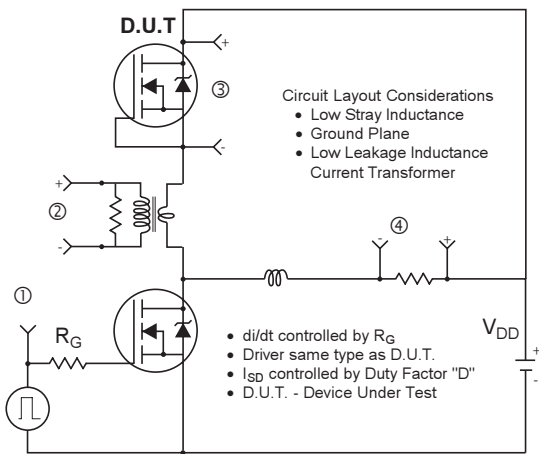
**Fig 15.** Threshold Voltage vs. Temperature



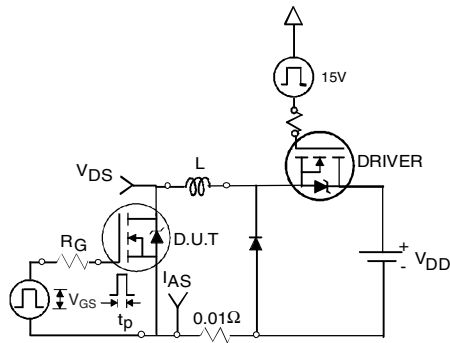
**Fig 16.** Typical Repetitive peak Current vs. Case temperature



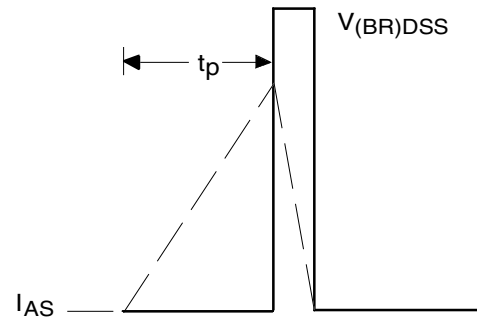
**Fig 17.** Maximum Effective Transient Thermal Impedance, Junction-to-Case



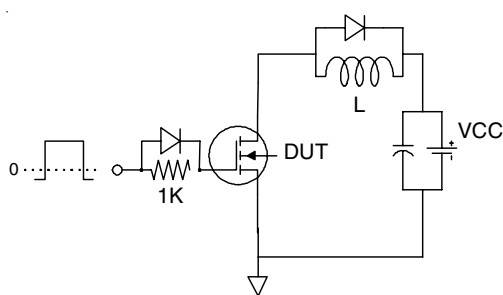
**Fig 18.** Diode Reverse Recovery Test Circuit for N-Channel HEXFET® Power MOSFETs



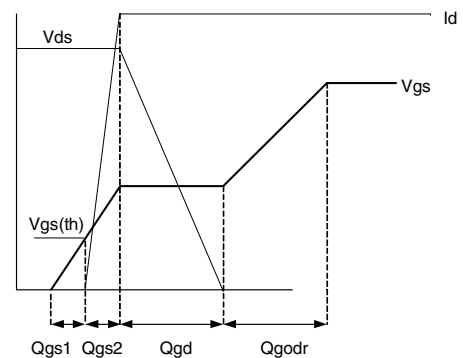
**Fig 19a.** Unclamped Inductive Test Circuit



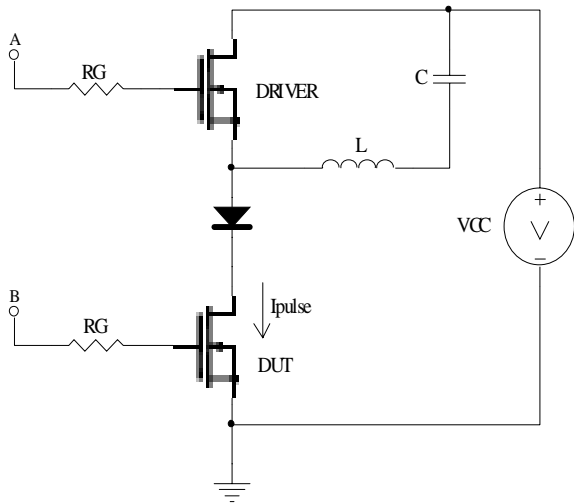
**Fig 19b.** Unclamped Inductive Waveforms



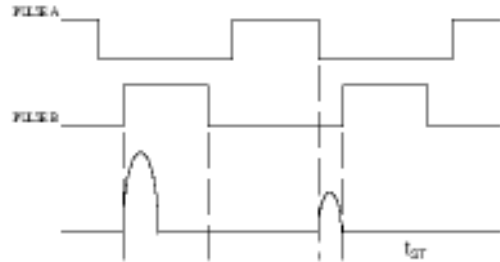
**Fig 20a.** Gate Charge Test Circuit



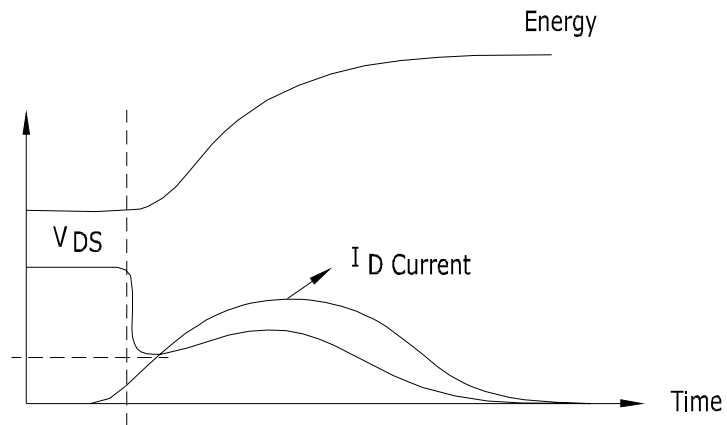
**Fig 20b.** Gate Charge Waveform



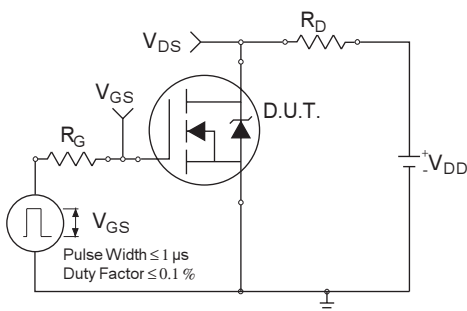
**Fig 21a.**  $t_{st}$  and  $E_{PULSE}$  Test Circuit



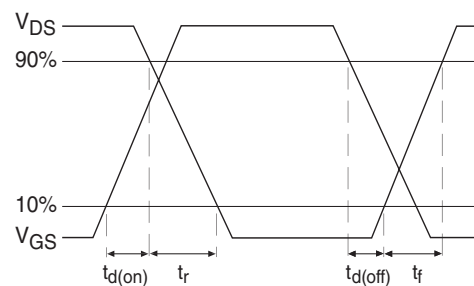
**Fig 21b.**  $t_{st}$  Test Waveforms



**Fig 21c.**  $E_{PULSE}$  Test Waveforms



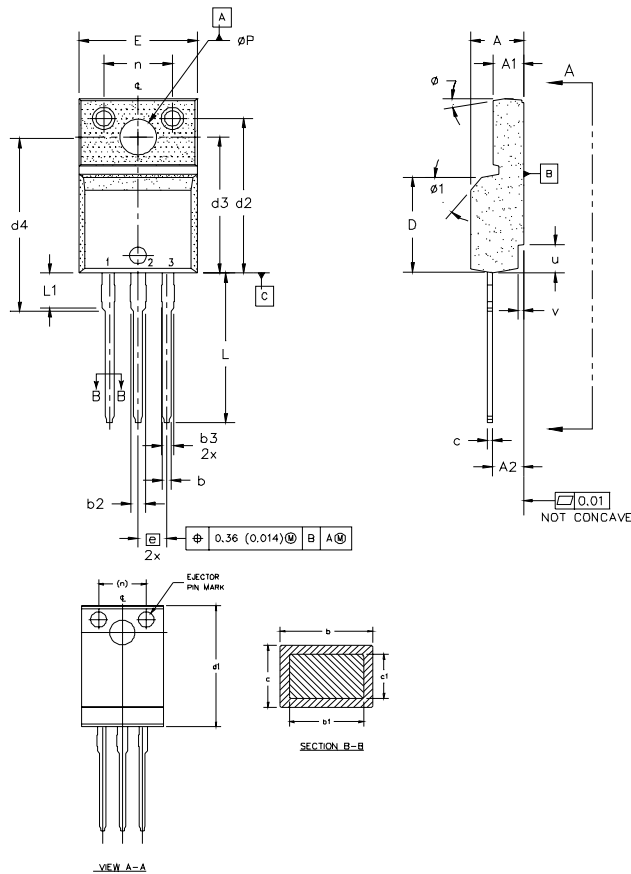
**Fig 22a.** Switching Time Test Circuit



**Fig 22b.** Switching Time Waveforms

# IRFI4229PbF

## TO-220AB Full-Pak Package Outline (Dimensions are shown in millimeters (inches))



NOTES:

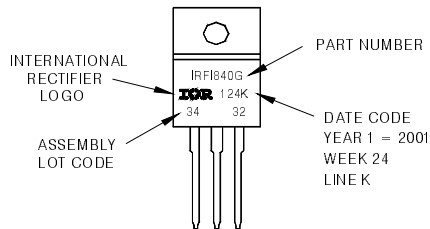
- 1.0 DIMENSIONING AND TOLERANCING PER ASME Y14.5 M- 1994.
- 2.0 DIMENSIONS ARE SHOWN IN MILLIMETERS [INCHES].
- 3.0 LEAD DIMENSION AND FINISH UNCONTROLLED IN L1.
- 4.0 DIMENSION D & E DO NOT INCLUDE MOLD FLASH. MOLD FLASH SHALL NOT EXCEED 0.005" (0.127) PER SIDE. THESE DIMENSIONS ARE MEASURED AT THE OUTERMOST EXTREMES OF THE PLASTIC BODY.
- 5.0 DIMENSION b1 APPLY TO BASE METAL ONLY.
- 6.0 STEP OPTIONAL ON PLASTIC BODY DEFINED BY DIMENSIONS u & v.
- 7.0 CONTROLLING DIMENSION : INCHES.

SYMBOL	DIMENSIONS				NOTES	LEAD ASSIGNMENTS
	MILLIMETERS		INCHES			
	MIN.	MAX.	MIN.	MAX.		
A	4.57	4.83	0.180	0.190		
A1	2.57	2.83	0.101	0.114		
A2	2.51	2.85	0.099	0.112		
b	0.622	0.89	0.024	0.035		
b1	0.622	0.838	0.024	0.033	5	1.- GATE 2.- DRAIN 3.- SOURCE
b2	1.229	1.400	0.048	0.055		
b3	1.229	1.400	0.048	0.055		
c	0.440	0.629	0.017	0.025		
c1	0.440	0.584	0.017	0.023		
D	8.65	9.80	0.341	0.386	4	
d1	15.80	16.12	0.622	0.635		
d2	13.97	14.22	0.550	0.560		
d3	12.30	12.92	0.484	0.509		
d4	8.64	9.91	0.340	0.390		
E	10.36	10.63	0.408	0.419	4	
e	2.54 BSC		0.100 BSC			
L	13.20	13.73	0.520	0.541		
L1	3.10	3.50	0.122	0.138	3	
n	6.05	6.15	0.238	0.242		
phi P	3.05	3.45	0.120	0.136		
u	2.40	2.50	0.094	0.098	6	
v	0.40	0.50	0.016	0.020	6	
phi	3°	7°	3°	7°		
phi 1		45°		45°		

## TO-220AB Full-Pak Part Marking Information

EXAMPLE: THIS IS AN IRFI840G  
WITH ASSEMBLY  
LOT CODE 3432  
ASSEMBLED ON WW 24, 2001  
IN THE ASSEMBLY LINE 'K'

Note: 'P' in assembly line position  
indicates 'Lead-Free'



TO-220AB Full-Pak packages are not recommended for Surface Mount Application.

### Notes:

- ① Repetitive rating; pulse width limited by max. junction temperature.
- ② Starting  $T_J = 25^\circ\text{C}$ ,  $L = 1.9\text{mH}$ ,  $R_G = 25\Omega$ ,  $I_{AS} = 11\text{A}$ .
- ③ Pulse width  $\leq 400\mu\text{s}$ ; duty cycle  $\leq 2\%$ .
- ④  $R_\theta$  is measured at  $T_J$  of approximately  $90^\circ\text{C}$ .
- ⑤ Half sine wave with duty cycle = 0.25,  $t_{on} = 1\mu\text{sec}$ .

Note: For the most current drawing please refer to IR website at: <http://www.irf.com/package/>

Data and specifications subject to change without notice.  
This product has been designed and qualified for the Industrial market.  
Qualification Standards can be found on IR's Web site.