

#### PROTECTION PRODUCTS - EMIClamp®

#### Description

The EClamp®2122S is combination EMI filter and line termination device with integrated TVS diodes for use on USB 2.0 interfaces. This device utilizes solid-state silicon-avalanche technology for superior clamping performance and DC electrical characteristics. They have been optimized for **protection of USB interfaces** in cellular phones and other portable electronics.

USB line termination is achieved with a series 22Ω resistor on both the D+ and D- USB lines. These resistors preserve signal integrity by matching the cable impedance to that of the differential driver. The 15kΩ pull-down resistors complete the termination circuit on each line. They are required by the USB specification to identify the line as a downstream connection. The capacitors are used to bypass high frequency energy to ground and for edge rate control of the USB signals. Integrated TVS diodes provide ESD protection of both (D+ & D-) data lines and the voltage bus (V<sub>BUS</sub>). The TVS diodes provide effective suppression of ESD voltages in excess of 25kV (air discharge) and 20kV (contact discharge) per IEC 61000-4-2.

The EClamp2122S is in a 6-pin SOT-23 package. The leads are finished with lead-free matte tin. It is suitable for use in USB hubs, computers, peripherals, and portable devices

#### Features

- ◆ EMI/RFI filtering and line termination with integrated ESD protection
- ◆ ESD protection for USB power (V<sub>BUS</sub>) and data lines (D+ & D-) to **IIEC 61000-4-2 (ESD), ±25kV (air), ±20kV (contact)**
- ◆ Filtering and termination for two USB data lines
- ◆ Series resistors for impedance matching
- ◆ Integrated pull down resistors as required by the USB specification for downstream ports
- ◆ Low TVS operating voltage (5.25V)
- ◆ Solid-state technology

#### Mechanical Characteristics

- ◆ JEDEC SOT-23 6L package
- ◆ Pb-Free, Halogen Free, RoHS/WEEE Compliant
- ◆ Nominal Dimensions: 2.9 x 2.8mm
- ◆ Molding compound flammability rating: UL 94V-0
- ◆ Marking: Marking Code + Date Code
- ◆ Packaging: Tape and Reel

#### Applications

- ◆ USB 1.1 Interfaces
- ◆ USB Hubs
- ◆ Printers
- ◆ Monitors
- ◆ Servers, Desktop, and Notebook computers

#### Circuit Diagram

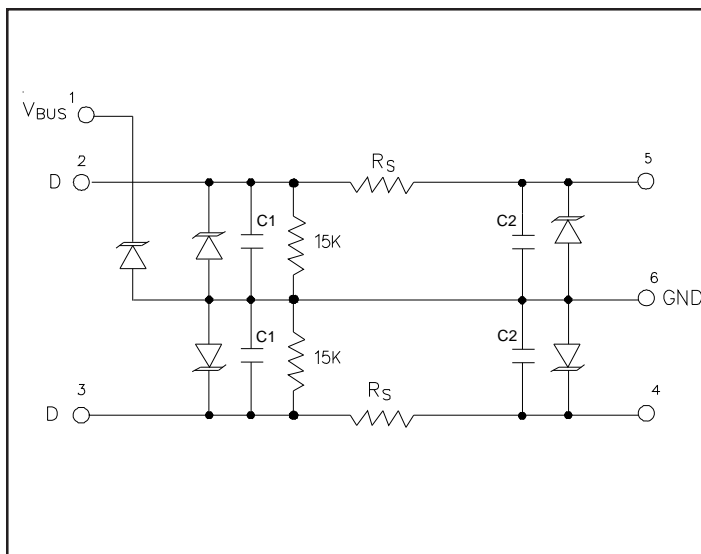

#### Pin Configuration

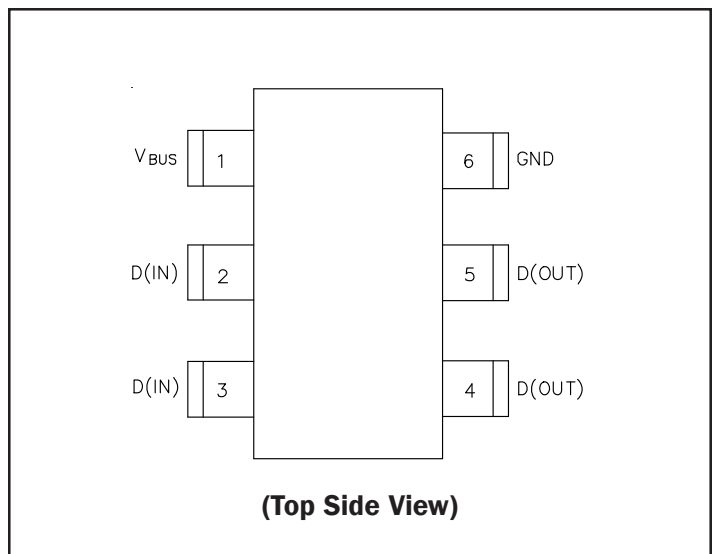

## PROTECTION PRODUCTS

### Absolute Maximum Rating

Rating	Symbol	Value	Units
Steady-State Power	$P_{SS}$	100	mW
ESD Air Discharge per IEC 61000-4-2 ESD Contact Discharge per IEC 61000-4-2	$V_{ESD}$	25 20	kV
Operating Temperature	$T_J$	-40 to +85	°C
Storage Temperature	$T_{STG}$	-55 to +150	°C

### Electrical Characteristics (T = 25°C)

Parameter	Symbol	Conditions	Minimum	Typical	Maximum	Units
TVS Reverse Stand-Off Voltage	$V_{RWM}$				5.25	V
TVS Reverse Breakdown Voltage	$V_{BR}$	$I_t = 1mA$	6			V
Series Resistance	$R_S$	Each Line	20	22	24	$\Omega$
Pulldown Resistance	$R_{PD}$	Each Line	13.5	15	16.5	k $\Omega$
TVS Diode Capacitance	C	Each Line $V_R = 0V, f = 1MHz$	27	30	33	pF
Total Capacitance	$C_{TOT}$	Between Input or Output to Ground $V_R = 0V, f = 1MHz$		50		pF

## PROTECTION PRODUCTS

### Typical Characteristics

**ESD Clamping (Pin 1 to GND)  
(8kV Contact per IEC 61000-4-2)**

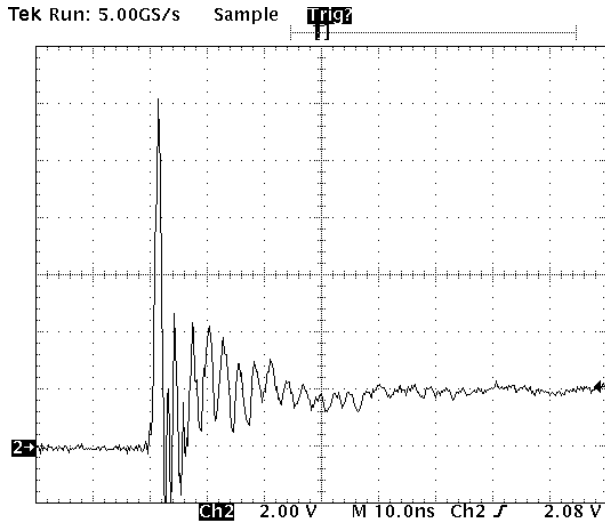

**ESD Clamping (Pin 1 to GND)  
(-8kV Contact per IEC 61000-4-2)**

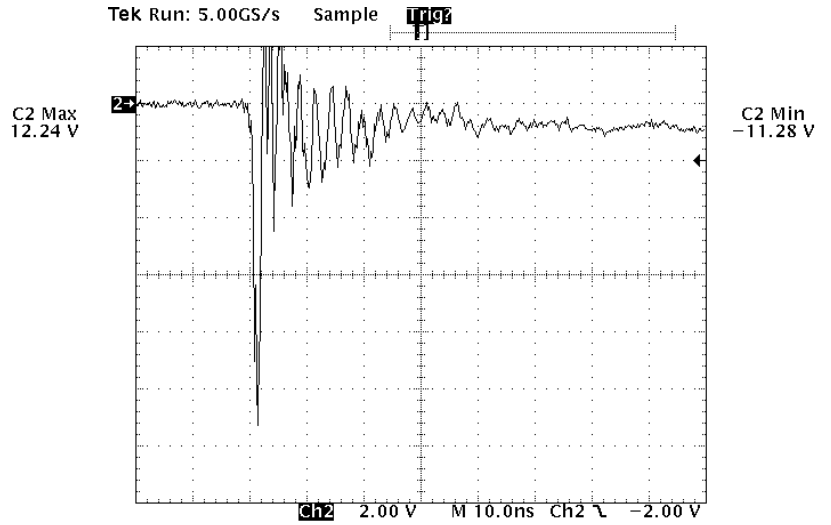

**ESD Clamping (Pin 4 or 5 to GND)  
(8kV Contact per IEC 61000-4-2)**

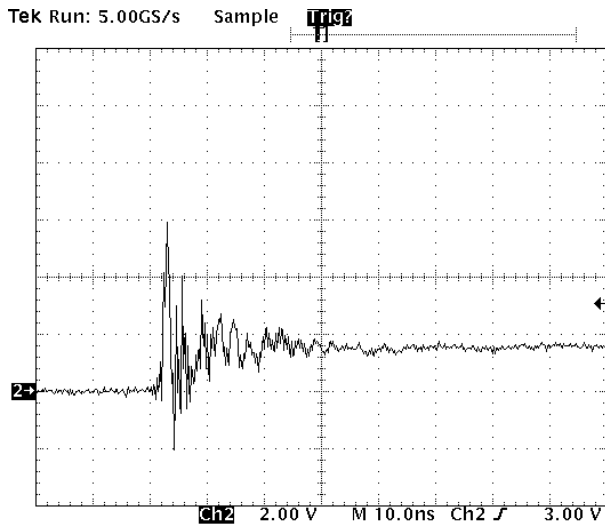

**ESD Clamping (Pin 4 or 5 to GND)  
(-8kV Contact per IEC 61000-4-2)**

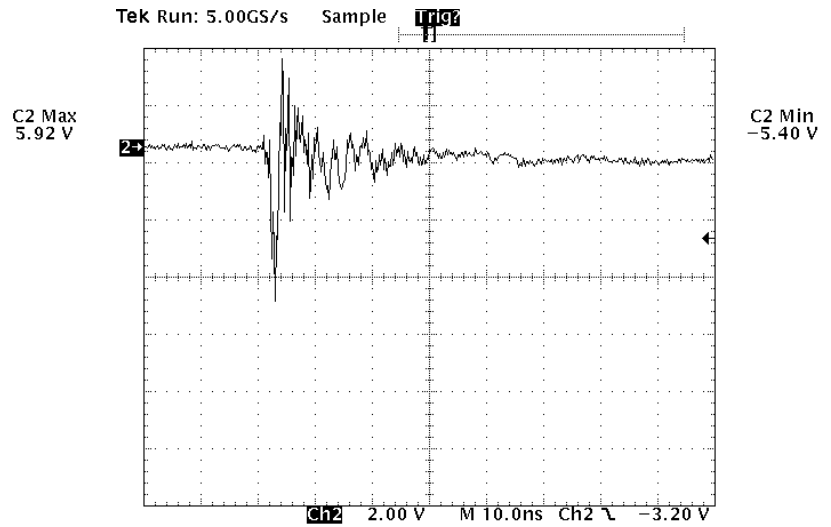

Note: ESD data is taken with a 20dB attenuator

**Typical Insertion Loss S21  
(Pin 2 to 5 with respect to GND)**

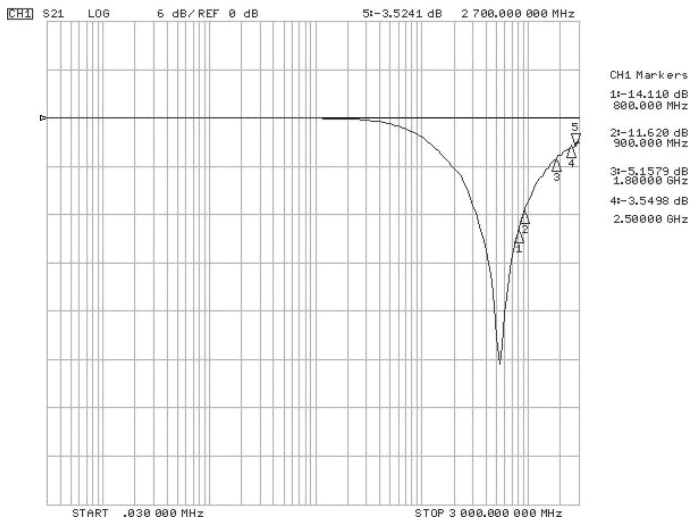

Frequency	S21 (dB)
114.9MHz	-3.00
800MHz	-14.11
900MHz	-11.62
1.8GHz	-5.16
2.5GHz	-3.55
2.7GHz	-3.52

**Typical Insertion Loss S21  
(Pin 3 to 4 with respect to GND)**

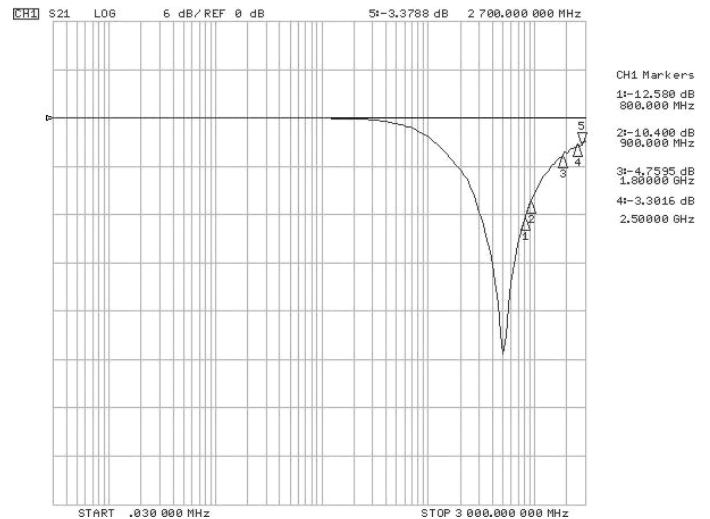

Frequency	S21 (dB)
114.6MHz	-3.00
800MHz	-12.58
900MHz	-10.40
1.8GHz	-4.76
2.5GHz	-3.30
2.7GHz	-3.38

**Normalized Junction Capacitance  
vs. Reverse Voltage (Data Pins)**

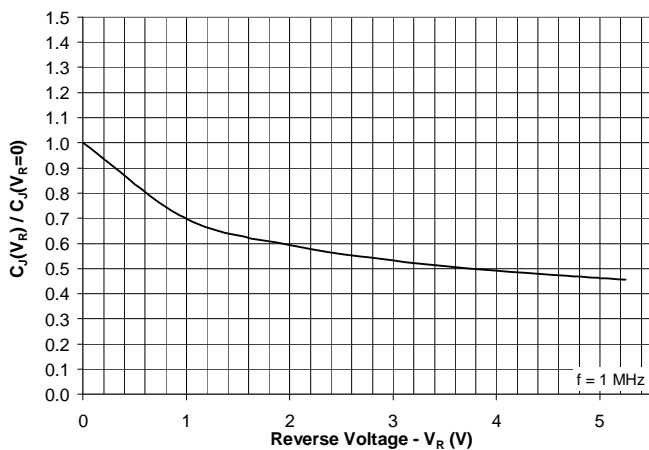

## PROTECTION PRODUCTS

### Applications Information

#### Device Connection

The EClamp2122S is designed to provide termination, EMI filtering and ESD protection for two USB I/O lines. The equivalent circuit diagram is shown in Figure 1. The device is connected as follows:

- USB data lines are routed through the EClamp2122S for easy implementation and optimum pc board layout. Pin 1 is connected to the voltage supply line. The input of the D+ line is routed into pin 2 and out of pin 5. The input of the D- line is connected at pin 3 and the output at pin 4. Pin 6 is connected to ground. The ground connection should be made directly to the ground plane for best results. The path length is kept as short as possible to reduce the effects of parasitic inductance in the board traces.

Figure 1 - EClamp2122S Circuit Diagram

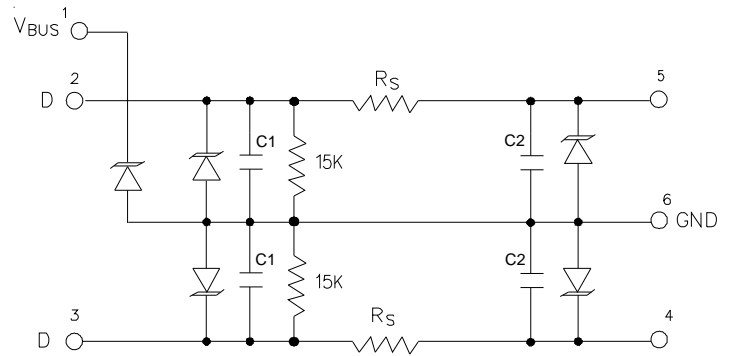

#### USB Port Design with EClamp2122S

The Universal Serial Bus (USB) specification requires termination and filtering components for proper operation. In addition, an open USB socket is vulnerable to hazardous ESD discharges in excess of 15kV. These discharges can occur on the data lines or the voltage bus. The EClamp2122S is an easily implemented solution designed to meet the termination & EMI filter requirements of the USB specification revision 1.1. It also provides ESD protection to IEC 61000-4-2.

USB line termination is achieved with series resistors on both the D+ and D- lines. These resistors preserve signal integrity by matching the cable impedance to that of the differential driver. 15kΩ pull-down resistors are used to identify a downstream port. Capacitors are used to bypass high frequency energy to ground and for edge rate control of the USB signals. Integrated TVS diodes provide ESD protection of both (D+ & D-) data lines and the voltage bus ( $V_{BUS}$ ).

General layout guidelines are given below:

- Avoid running D+ & D- signal line traces near high speed clock lines or similar signal lines.
- Avoid running critical signal lines near board edges.
- Place the EClamp2122S near the USB connector to restrict transient coupling.
- Minimize the path length between the USB connector and the EClamp2122S.

## PROTECTION PRODUCTS

### Outline Drawing - SOT-23 6L

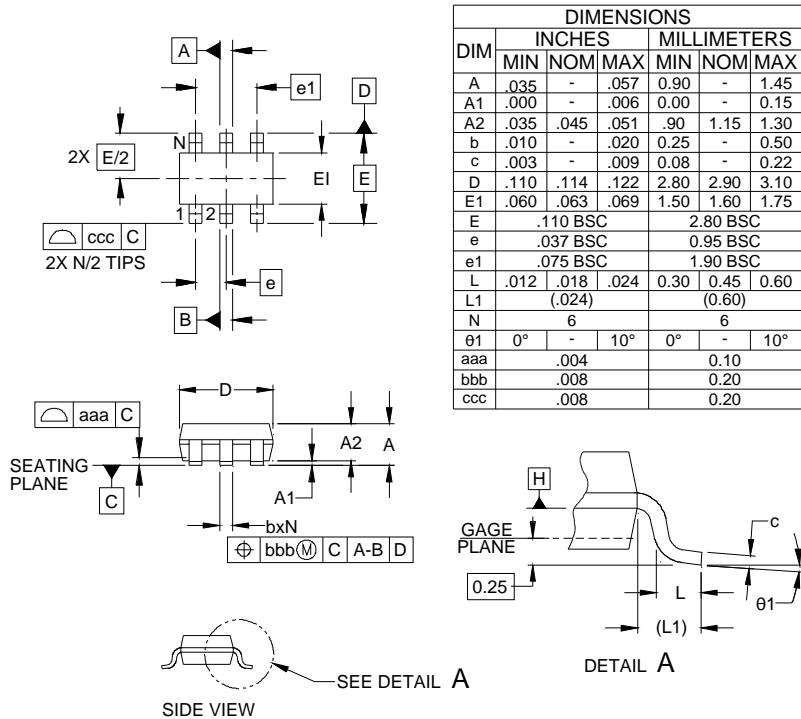

NOTES:

1. CONTROLLING DIMENSIONS ARE IN MILLIMETERS (ANGLES IN DEGREES).
2. DATUMS [-A-] AND [-B-] TO BE DETERMINED AT DATUM PLANE [-H-]
3. DIMENSIONS "E1" AND "D" DO NOT INCLUDE MOLD FLASH, PROTRUSIONS OR GATE BURRS.

### Land Pattern - SOT-23 6L

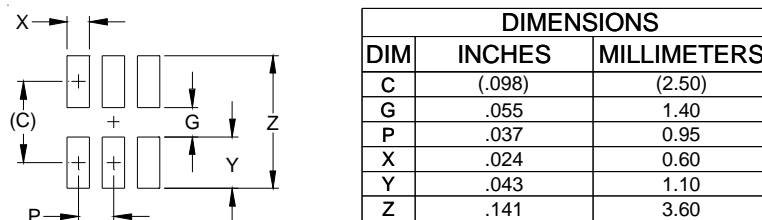

NOTES:

1. THIS LAND PATTERN IS FOR REFERENCE PURPOSES ONLY. CONSULT YOUR MANUFACTURING GROUP TO ENSURE YOUR COMPANY'S MANUFACTURING GUIDELINES ARE MET.

## PROTECTION PRODUCTS

### Marking

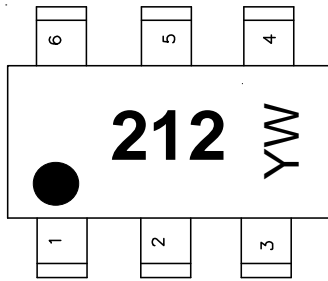

### Ordering Information

Part Number	Qty per Reel	Reel Size
EClamp2122S.TCT	3,000	7 Inch

Note: Lead finish is lead-free matte tin

EMIClamp and EClamp are trademarks of Semtech Corporation

YW = 2 - Alphanumeric characters for Date Code

### Tape and Reel Specification

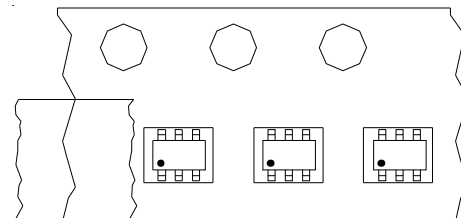
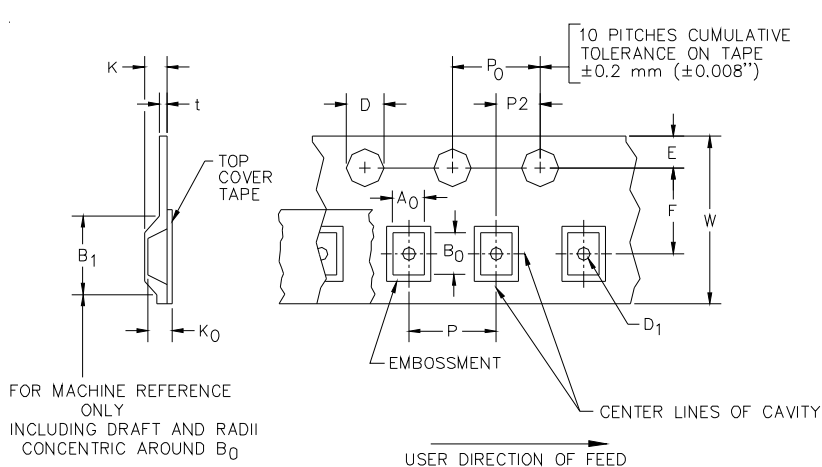

### Device Orientation in Tape

A0	B0	K0
3.23 +/-0.05 mm	3.17 +/-0.05 mm	1.37 +/-0.05 mm

Tape Width	B, (Max)	D	D1	E	F	K (MAX)	P	P0	P2	T(MAX)	W
8 mm	4.2 mm (.165)	1.5 + 0.1 mm - 0.0 mm	1.0 mm ±0.05	1.750±.10 mm	3.5±0.05 mm	2.4 mm	4.0±0.1 mm	4.0±0.1 mm	2.0±0.05 mm	0.4 mm	8.0 mm + 0.3 mm - 0.1 mm

### Contact Information

Semtech Corporation  
 Protection Products Division  
 200 Flynn Rd., Camarillo, CA 93012  
 Phone: (805)498-2111 FAX (805)498-3804