

## Application note and implementation guideline **OnBoard™ SMD – 169 antenna**

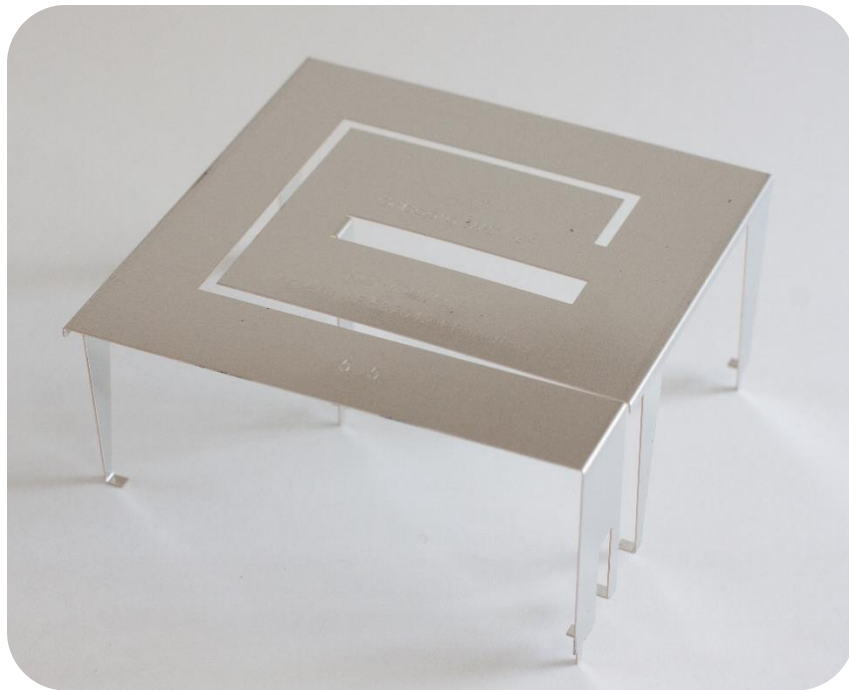

---

## TABLE OF CONTENTS

1. General .....	3
2. Intended applications.....	3
3. Technical data.....	3
4. Mechanical dimensions .....	4
5. PCB layout .....	5
6. Electrical performance.....	7
7. Radiation pattern .....	9
8. OnBoard SMD 169 MHz Evaluation board .....	10
9. General implementation guidelines.....	11
10. Package dimensions.....	12
11. Part marking .....	13
12. Disclaimer.....	13
13. Ordering information .....	13

## 1. General

This document is a guideline for implementation of the OnBoard SMD 169MHz antenna. The antenna is a combination of electrically small size, low cost and high performance. Integration of embedded antennas is a task that involves tradeoff of different aspects, and this document aims to help when optimizing the performance of the antenna solution.

## 2. Intended applications

The antenna is optimized for the 169 MHz band and can for example be implemented to M2M-applications, alarms and automated meter reading. Example of supported standard is:

Wireless M-Bus	EN 13757-4:2013 mode N	169.4-169.475 MHz
----------------	------------------------	-------------------

---

## 3. Technical data

Part number	PRO-OB-508
Frequency	169.4-169.8MHz
Impedance	50 $\Omega$
Return loss <sup>1</sup>	< -10dB
Total efficiency <sup>1</sup>	> 28%(-5.4dB)
Dimensions (LxBxH)	80 x 80 x 35 mm (3.15 x 3.15 x 1.378 in)
Soldering	Reflow or equivalent
Packing	Tray packing
Temperature	-40 to +125 <sup>0</sup> C

---

<sup>1)</sup> Measured on the Proant evaluation board 902 – 928 MHz, PRO- EB-532

#### 4. Mechanical dimensions

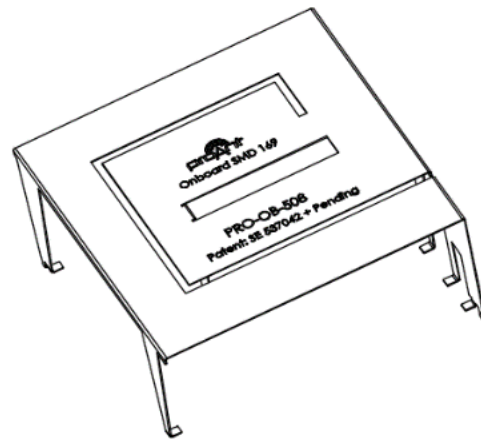
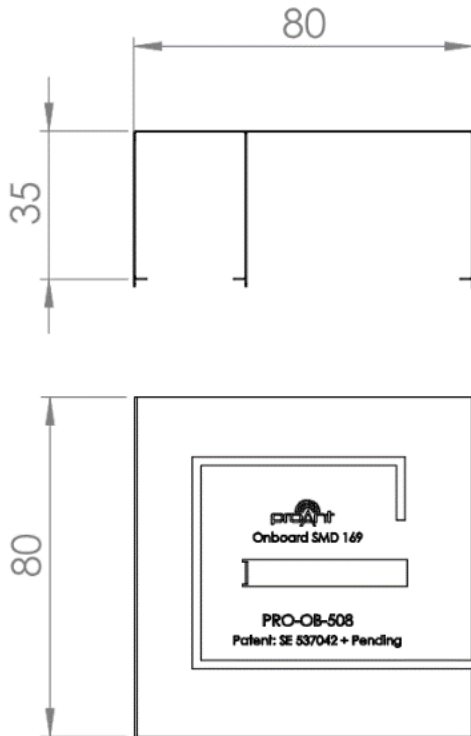

Antenna drawing. Above dimensions are given in millimeter.

## 5. PCB layout

The antenna is developed for optimum performance when mounted on a ground plane, and is therefore very suitably mounted on a printed circuit board, where all empty space in the layout shall be filled solid copper. This also means that no ground cutout area is required under the antenna. If there are several layers in the PCB, there is an advantage to add via holes for interconnection of the ground areas. It is also very important that there is a ground clearance around the NC pads and the RF feed pad, through all layers of the PCB. Otherwise there will be capacitive coupling which may detune the antenna.

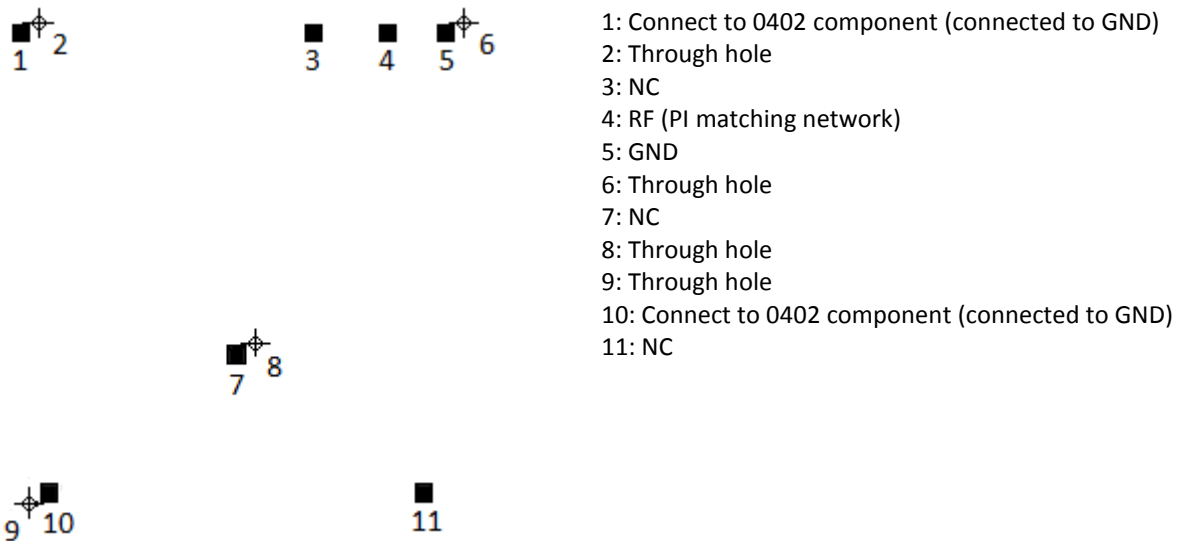

### Pin configuration

The antenna is preferably positioned along one side of the PCB ground plane, where pin 5 shall be as close as possible to the layout corner.

It is also recommended to implement a pi-matching network as seen in the PCB layout to compensate for eventual mismatch due to the practical implementation. The components can be positioned below the antenna next to the feed pad. See chapter 8 for more details.

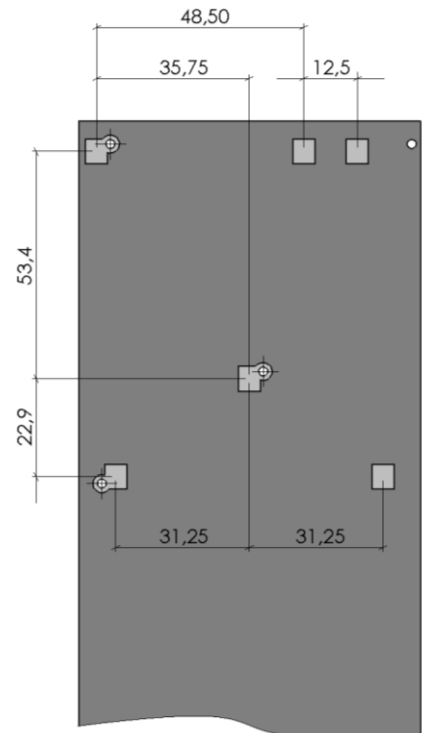
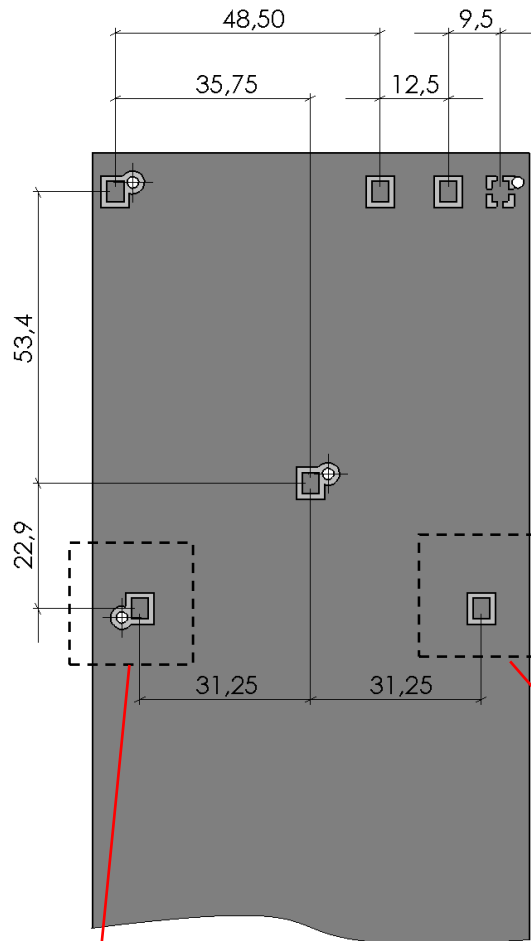

Copper keep out applies to all layers

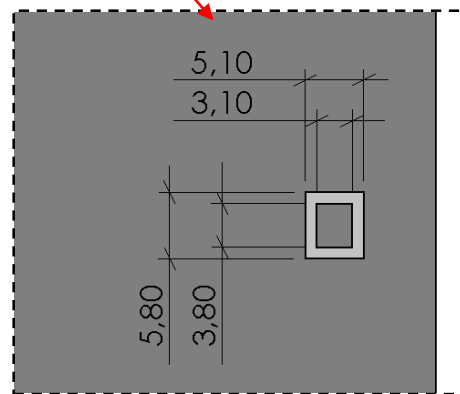
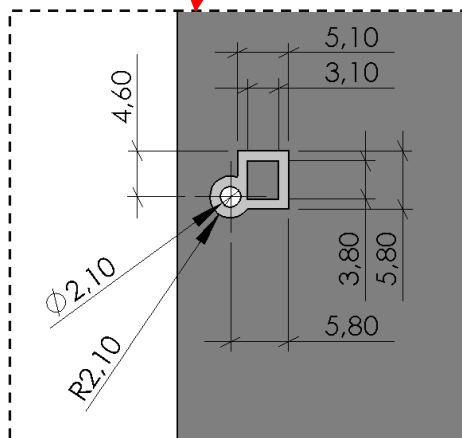

PCB Layout (from evaluation board)

## 6. Electrical performance

All results are measured with the antenna mounted on the evaluation board.

Smith chart

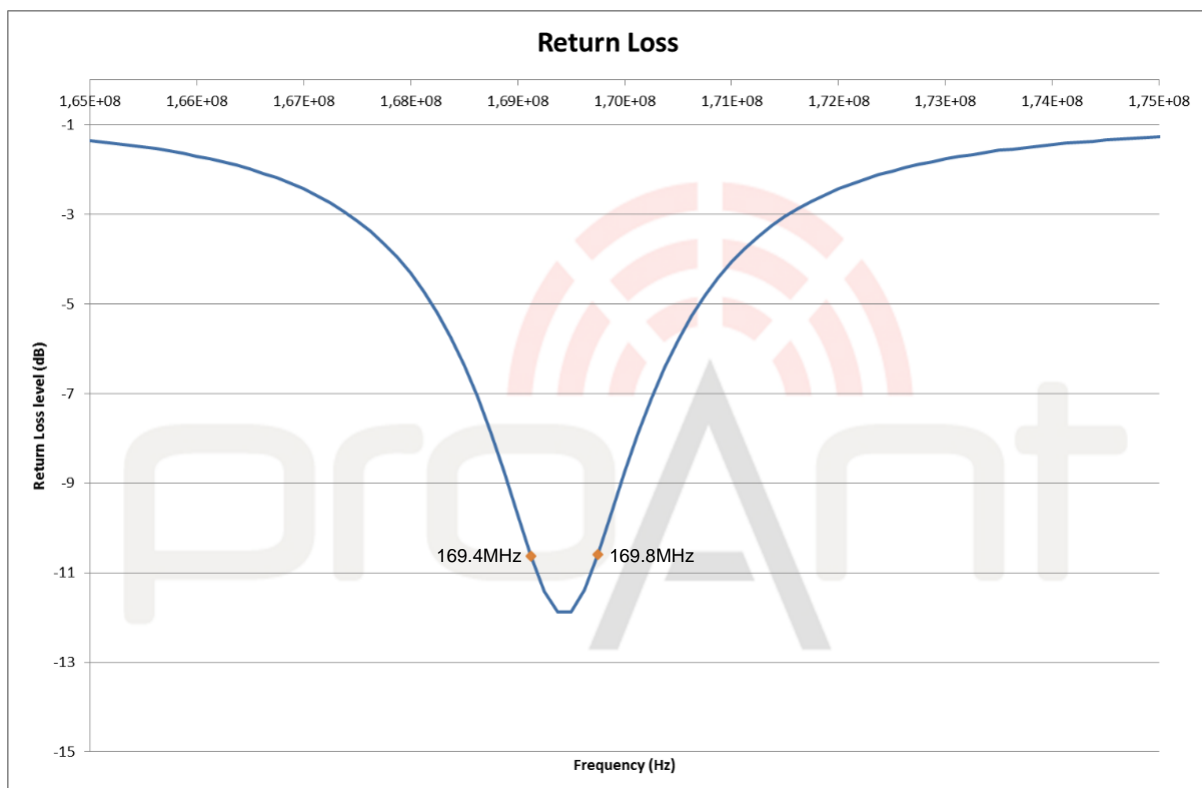
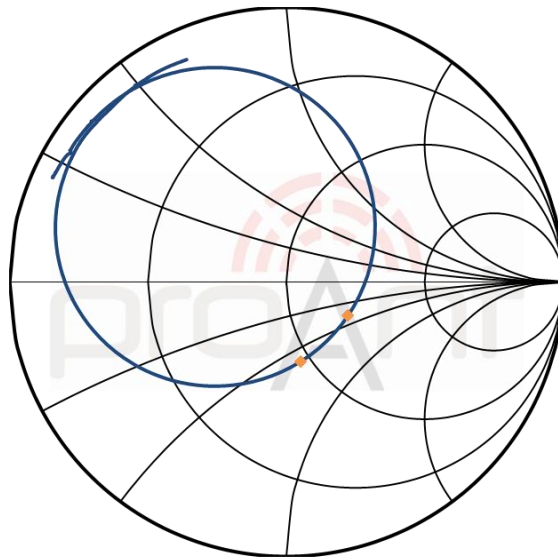

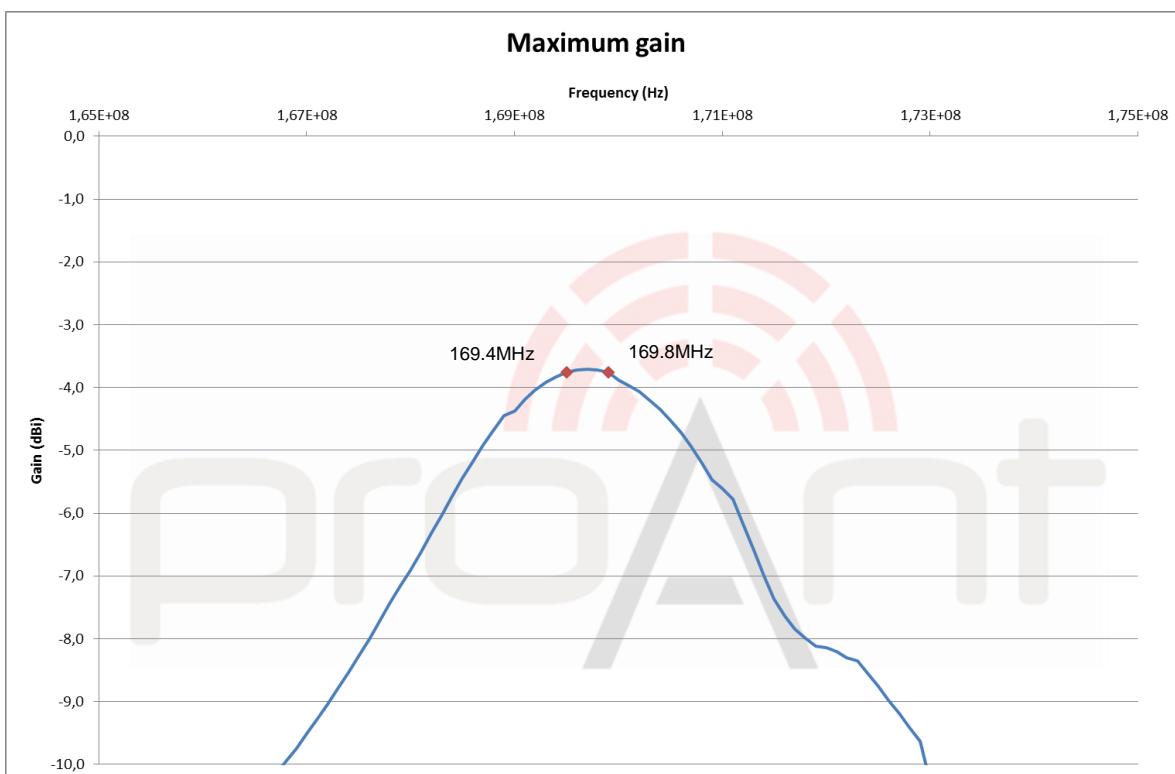
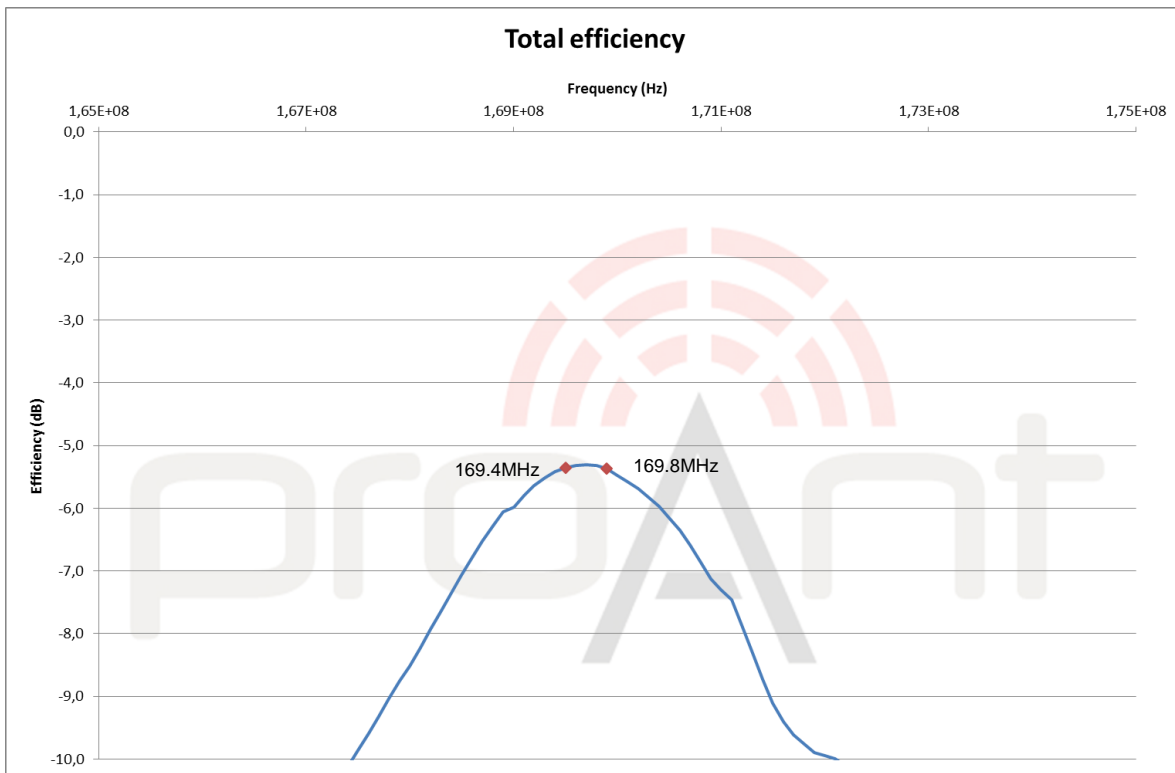



## 7. Radiation pattern

All results are measured with antenna mounted on the evaluation board. The figure to the right shows the corresponding antenna position for each chart. Gain values are given in dBi.

VP = Vertical Polarization, HP = Horizontal Polarization.

**Frequency = 169.6 MHz**

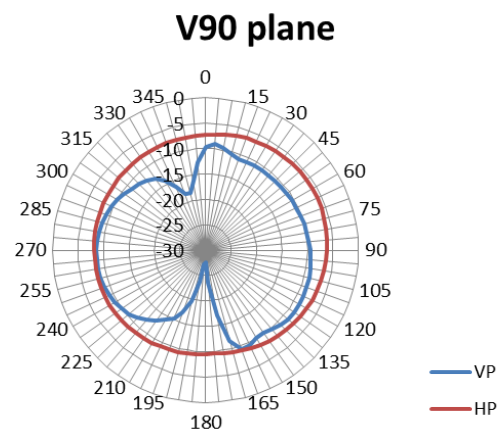
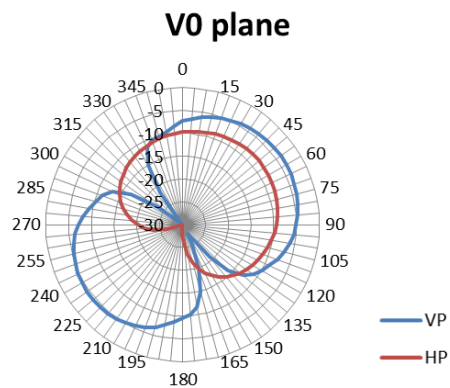
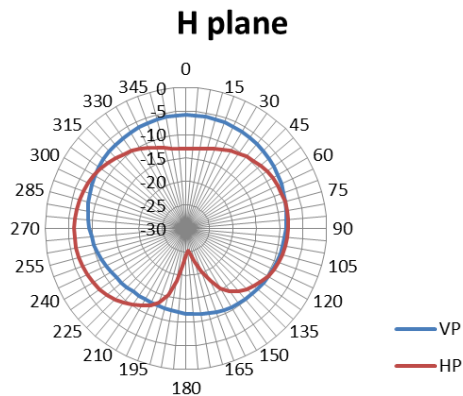

## 8. OnBoard SMD 169 MHz Evaluation board

The evaluation board is developed to simplify antenna testing and evaluation. It has an arbitrary size of 190 x 80 mm and includes an SMA connector. The purpose is to give a reference design for an optimal antenna implementation. The evaluation board can also be used to test other implementations by cutting and soldering the PCB into any device.

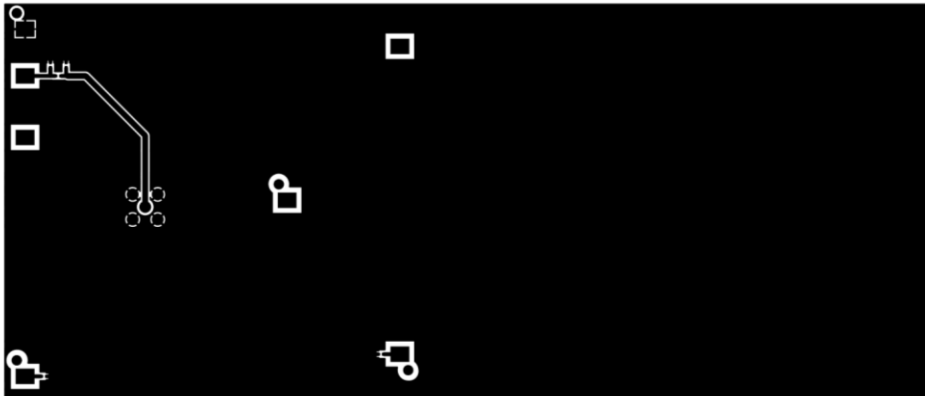

### Evaluation board outline

The evaluation board has a matching circuit implemented next to the antenna, and two of the antenna pads can be connected to GND via components. This is done to enable optimization possibilities for the user. The component positions are sized for 0402 (1005 metric) SMD components.

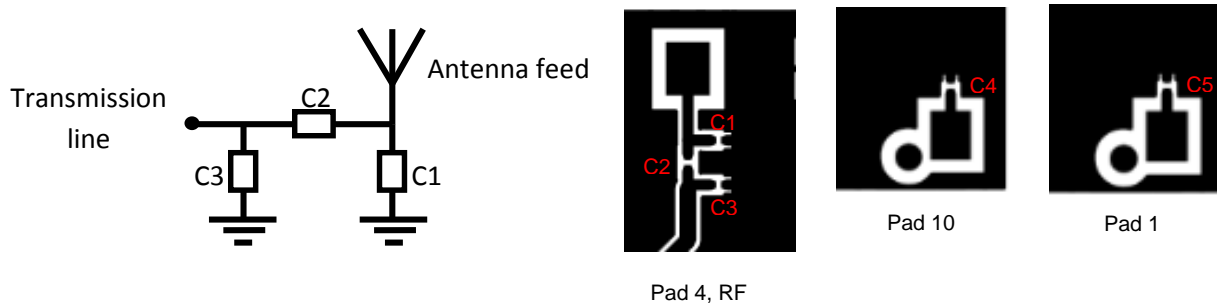

### Matching circuit

The antenna needs a matching circuit to adjust the resonant frequency balance. When delivered, the evaluation board is tuned for optimum balance at the 169 MHz frequency band. The component values for this setup are:

C1 = N/A      C4 = 2.2 pF (Murata GRM1555C1H2R2WA01D)  
 C2 = 0Ω      C5 = 1.2 pF (Murata GRM1555C1H1R2WA01D)  
 C3 = N/A

However, it is common that the resonant frequency will shift during implementation in an arbitrary device. Therefore this matching may be changed for compensation of such effects. This is further described in chapter 9.

## 9. General implementation guidelines

The antenna can be positioned in many ways, although there are some positions which are more beneficial. Below picture shows a typical PCB with two possible antenna positions that give good radiation performance.

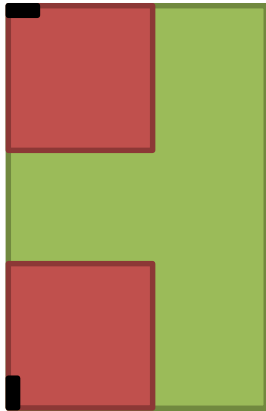

■ = feed section (pin 4 & 5)

The antenna should be aligned with the PCB edge if possible. It is also important to align pin 1 & 2 along the outer side of the PCB, and even more preferably close to a corner.

The OnBoard SMD 169 antenna enables that electrical components are mounted inside the antenna keep-out block. This may have an impact on the antenna tuning and radiated performance, but is fully possible if there is limited space on the PCB.

Another general aspect on surface mounted antennas is regarding the PCB population. If other electrical components are positioned in the surrounding area of the antenna, some impact on the antenna tuning and radiated performance may be expected. It is recommended that such components are distributed below a topographical slope that starts on PCB level at the antenna keep-out block, and slowly increases the height.

It shall also be highlighted that plastic and metal parts in the near proximity of antennas may influence the antenna tuning and/or performance. This aspect should be noted as a general guideline for all antennas. The effects are difficult to estimate without detailed information, but it is common that a plastic housing above the antenna shifts the resonant frequency down. It is recommended to measure the antenna in the actual device after implementation.

### 10. Package dimensions

The antenna is delivered in tray according to following specifications. The quantity per tray is 6 pcs.

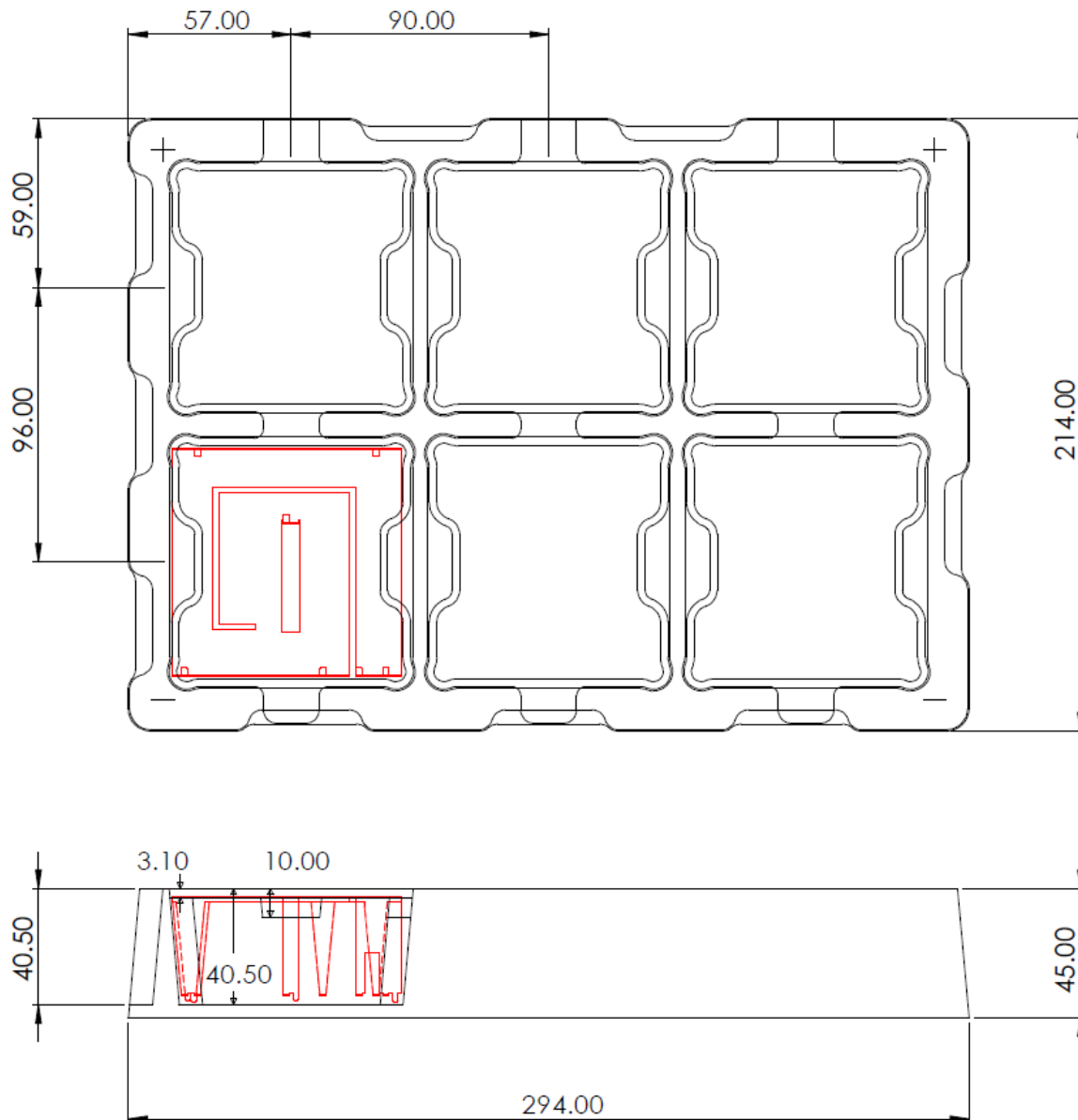

## 11. Part marking

The top marking of the antenna is arranged according to the following illustration.

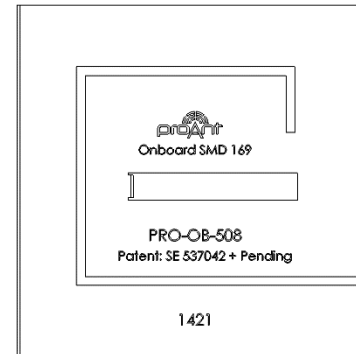
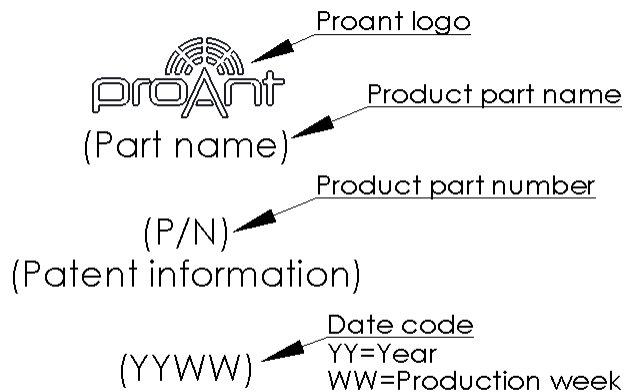

Example top marking

## 12. Disclaimer

The information given in this application note shall in no event be regarded as a guarantee of conditions or characteristics. With respect to any examples or hints given herein, any typical values stated herein and/or any information regarding the application of the device, Proant AB hereby disclaims any and all warranties and liabilities of any kind, including without limitation, warranties of non-infringement of intellectual property rights of any third party.

## 13. Ordering information

For information on sales, delivery terms and conditions and prices, please visit the Proant website ([www.proant.se](http://www.proant.se)) for a complete list of distributors.

Proant offers consultation with design-in of the OnBoard SMD 169 MHz, as well as design of matching network and transmission lines. Proant have all necessary capabilities for antenna design including anechoic chamber and prototype workshop. Please send your requests to [info@proant.se](mailto:info@proant.se).