

8 PIN SOP DUAL CHANNEL HIGH SPEED 1Mbit/s TRANSISTOR PHOTOCOUPLER EL053X series

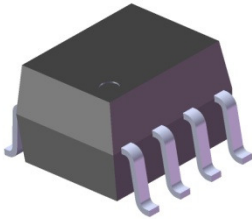

Features

- Compliance Halogen Free .
(Br <900 ppm ,Cl <900 ppm , Br+Cl < 1500 ppm)
- High speed 1Mbit/s
- High isolation voltage between input and output (Viso=3750 Vrms)
- Guaranteed performance from 0°C to 70°C
- Wide operating temperature range of -55°C to 100°C
- Compliance with EU REACH
- Pb free and RoHS compliant
- UL and cUL approved(No. E214129)
- VDE approved (No. 40028116)
- SEMKO approved
- NEMKO approved
- DEMKO approved
- FIMKO approved

Schematic

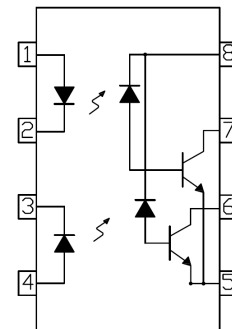

Pin Configuration

1. Anode
2. Cathode
3. Cathode
4. Anode
5. Gnd
6. Vout 2
7. Vout 1
8. Vcc

Description

The EL053X devices each consist of an infrared emitting diode, optically coupled to a high speed photo detector transistor. A separate connection for the photodiode bias and output-transistor collector increase the speed by several orders of magnitude over conventional phototransistor couplers by reducing the base-collector capacitance of the input transistor.

The devices are packaged in an 8-pin small outline package which conforms to the standard SO-8 footprint.

Applications

- Line receivers
- Telecommunication equipments
- Power transistor isolation in motor drives
- Replacement for low speed phototransistor photo couplers
- Feedback loop in switch-mode power supplies
- Home appliances
- High speed logic ground isolation

Absolute Maximum Ratings (Ta=25°C)

	Parameter	Symbol	Rating	Unit
Input	Forward current	I_F	25	mA
	Peak forward current (50% duty, 1ms P.W)	I_{FP}	50	mA
	Peak transient current ($\leq 1\mu s$ P.W, 300pps)	I_{Ftrans}	1	A
	Reverse voltage	V_R	5	V
	Power dissipation	P_{IN}	45	mW
Output	Power dissipation	P_O	100	mW
	Emitter-Base reverse voltage	V_{EBR}	5	V
	Average Output current	$I_{O(AVG)}$	8	mA
	Peak Output current	$I_{O(PK)}$	16	mA
	Output voltage	V_O	-0.5 to 20	V
	Supply voltage	V_{CC}	-0.5 to 30	V
	Isolation voltage ^{*1}	V_{ISO}	3750	V rms
	Operating temperature	T_{OPR}	-55 ~ +100	°C
	Storage temperature	T_{STG}	-55 ~ +125	°C
	Soldering temperature ^{*2}	T_{SOL}	260	°C

Notes:

*1 AC for 1 minute, R.H.= 40 ~ 60% R.H. In this test, pins 1, 2, 3, 4 are shorted together, and pins 5, 6, 7, 8 are shorted together.

*2 For 10 seconds

Electrical Characteristics (T_A=0 to 70°C unless specified otherwise)

Input

Parameter	Symbol	Min.	Typ.	Max.	Unit	Condition
Forward voltage	V _F	-	1.4	1.8	V	I _F = 16mA
Reverse Voltage	V _R	5.0	-	-	V	I _R = 10μA
Temperature coefficient of forward voltage	ΔV _F /ΔT _A	-	-1.6	-	mV/°C	I _F =16mA
Input Capacitance	C _{IN}	-	60	-	pF	V _F =0V, f=1MHz

Output

Parameter	Symbol	Min	Typ.	Max.	Unit	Condition
Logic High Output Current	I _{OH}	-	0.001	0.5	μA	I _F =0mA, V _O =V _{CC} =5.5V, T _A =25°C
		-	0.01	1		I _F =0mA, V _O =V _{CC} =15V, T _A =25°C
		-	-	50		I _F =0mA, V _O =V _{CC} =15V
Logic Low Supply Current	I _{CCL}	-	120	200	μA	I _F =16mA, V _O =Open, V _{CC} =15V
Logic High Supply Current	I _{CCH}	-	0.01	1	μA	I _F =0mA, V _O =Open, V _{CC} =15V, T _A =25°C
		-	-	2		I _F =0mA, V _O =Open, V _{CC} =15V

Transfer Characteristics (T_A=0 to 70°C unless specified otherwise)

Parameter	Symbol	Min	Typ.	Max.	Unit	Condition
Current Transfer Ratio	EL0530	7	-	50	%	I _F = 16mA, V _O = 0.4V, V _{CC} =4.5V, T _A =25°C
	EL0531	19	-	50		
	EL0530	5	-	-		
	EL0531	15	-	-		
Logic Low Output Voltage	EL0530	-	0.18	0.4	V	I _F = 16mA, I _O = 1.1mA, V _{CC} =4.5V, T _A =25°C
	EL0531	-	0.30	0.4		
	EL0530	-	-	0.5		
	EL0531	-	-	0.5		

Switching Characteristics ($T_A=0$ to 70°C unless specified otherwise, $I_F=16\text{mA}$, $V_{CC}=5\text{V}$)

Parameter	Symbol	Min	Typ.	Max.	Unit	Condition
Propagation Delay Time to Logic Low	EL0530	-	-	1.5	μs	$R_L=4.1\text{K}\Omega$, $T_A=25^\circ\text{C}$
		-	-	2.0		$R_L=4.1\text{K}\Omega$
	EL0531	-	-	0.8		$R_L=1.9\text{K}\Omega$, $T_A=25^\circ\text{C}$
		-	-	1.0		$R_L=1.9\text{K}\Omega$
Propagation Delay Time to Logic High	EL0530	-	-	1.5	μs	$R_L=4.1\text{K}\Omega$, $T_A=25^\circ\text{C}$
		-	-	2.0		$R_L=4.1\text{K}\Omega$
	EL0531	-	-	0.8		$R_L=1.9\text{K}\Omega$, $T_A=25^\circ\text{C}$
		-	-	1.0		$R_L=1.9\text{K}\Omega$
Common Mode Transient Immunity at Logic High	EL0530	1,000	10,000	-	$\text{V}/\mu\text{s}$	$I_F = 0\text{mA}$, $V_{CM}=10\text{Vp-p}$, $R_L=4.1\text{K}\Omega$, $T_A=25^\circ\text{C}$
	EL0531	1,000	-	-		$I_F = 0\text{mA}$, $V_{CM}=1500\text{Vp-p}$, $R_L=1.9\text{K}\Omega$, $T_A=25^\circ\text{C}$
Common Mode Transient Immunity at Logic Low (Fig.9) ₃	EL0530	1,000	10,000	-	$\text{V}/\mu\text{s}$	$I_F = 16\text{mA}$, $V_{CM}=10\text{Vp-p}$, $R_L=4.1\text{K}\Omega$, $T_A=25^\circ\text{C}$
	EL0531	1,000	-	-		$I_F = 16\text{mA}$, $V_{CM}=1500\text{Vp-p}$, $R_L=1.9\text{K}\Omega$, $T_A=25^\circ\text{C}$

Typical Electro-Optical Characteristics Curves

Figure 1. Forward Current vs Forward Voltage

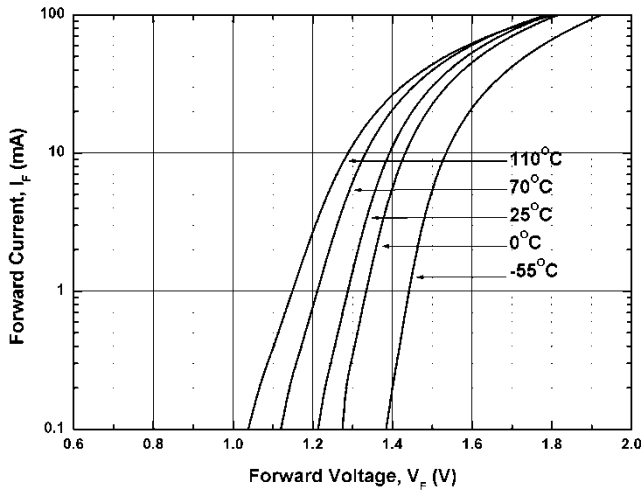

Figure 2. Current Transfer Ratio vs Forward Current

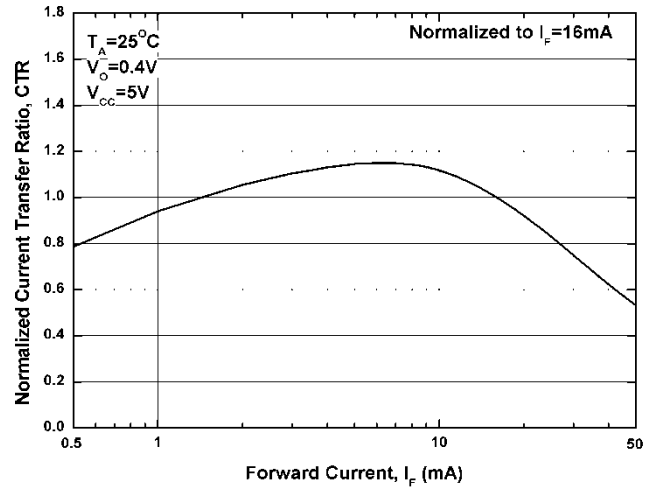

Figure 3. Current Transfer Ratio vs Ambient Temperature

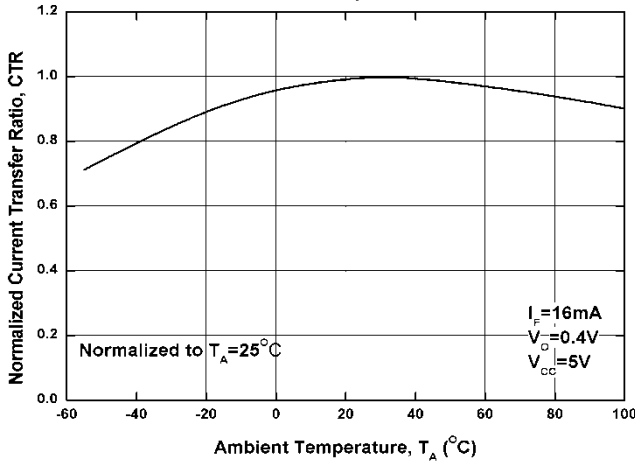

Figure 4. Output Current vs Output Voltage

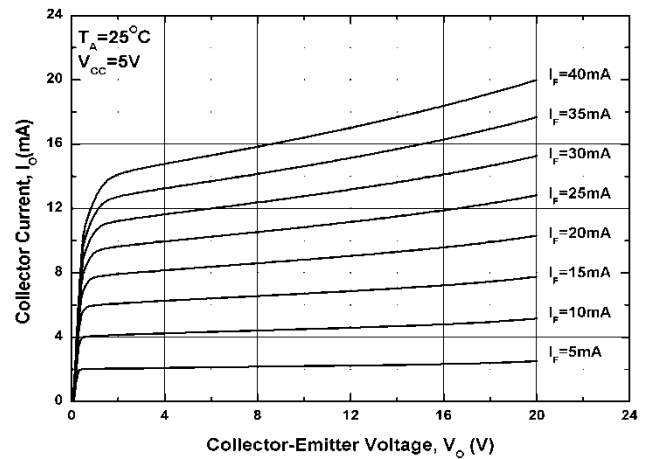

Figure 5. Logic High Output Current vs Ambient Temperature

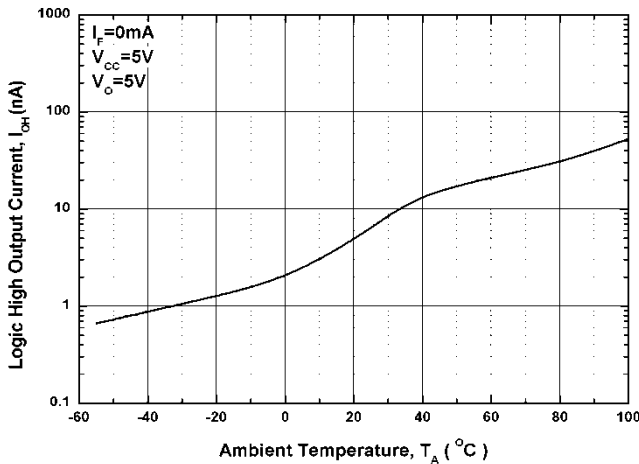

Figure 6. Propagation Delay vs. Load Resistance

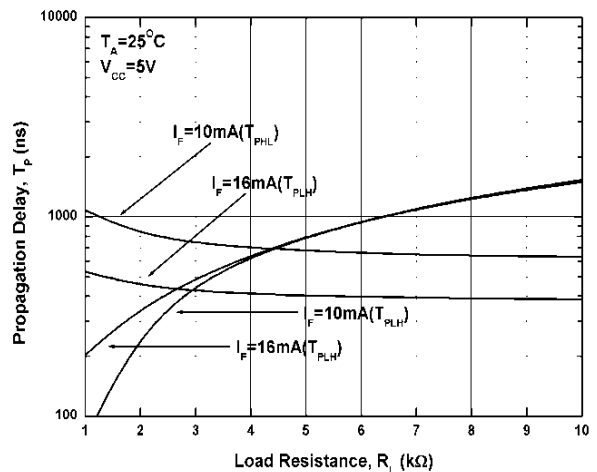

Figure 7. Propagation Delay vs. Temperature

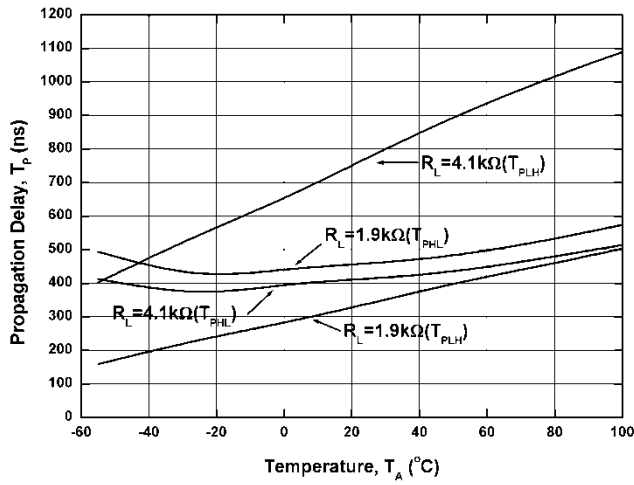

Figure 8 Switching Time Test Circuit & Waveform

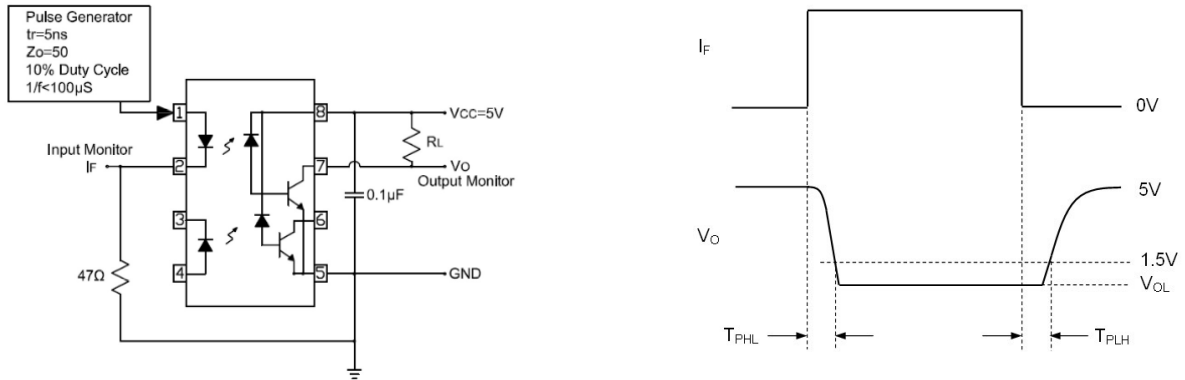
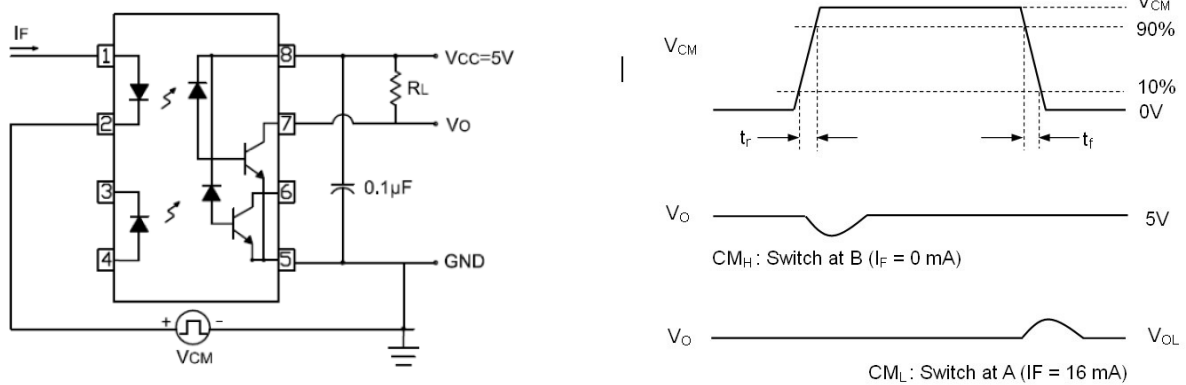

Figure 9 Transient Immunity Test Circuit & Waveform



Note:

*3 Common mode transient immunity in logic high level is the maximum tolerable (positive) dV_{CM}/dt on the leading edge of the common mode pulse signal V_{CM} , to assure that the output will remain in a logic high state (i.e., $V_O > 2.0V$).

Common mode transient immunity in logic low level is the maximum tolerable (negative) dV_{CM}/dt on the trailing edge of the common mode pulse signal, V_{CM} , to assure that the output will remain in a logic low state (i.e., $V_O < 0.8V$).

Order Information

Part Number

EL053X(Z)-V

Note

- X = Part No. (X = 0 or 1)
- Z = Tape and reel option (TA, TB or none)
- V = VDE (optional)

Option	Description	Packing quantity
None	Standard	100 units per tube
-V	Standard + VDE	100 units per tube
(TA)	TA tape & reel option	2000 units per reel
(TB)	TB tape & reel option	2000 units per reel
(TA)-V	TA tape & reel option + VDE	2000 units per reel
(TB)-V	TB tape & reel option + VDE	2000 units per reel

Package Dimension
(Dimensions in mm)

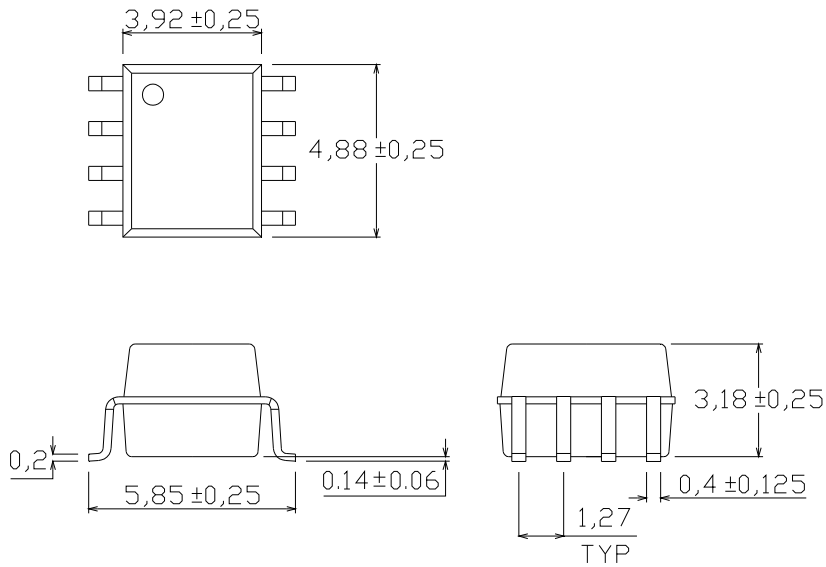

Recommended pad layout for surface mount leadform

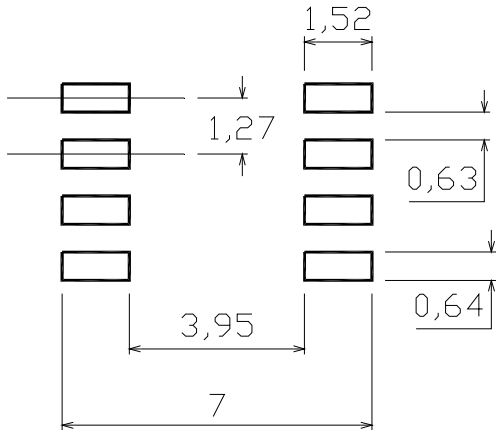

Device Marking

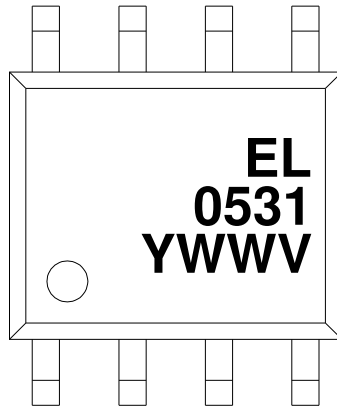

Notes

EL	denotes EVERLIGHT
0531	denotes Device Number
Y	denotes 1 digit Year code
WW	denotes 2 digit Week code
V	denotes VDE (optional)

Tape & Reel Packing Specifications

Option TA

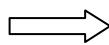
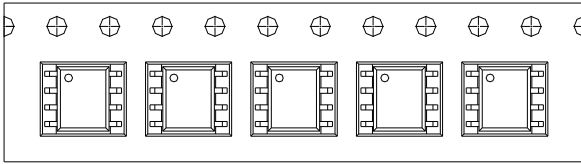

Direction of feed from reel

Option TB

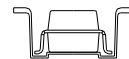
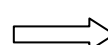
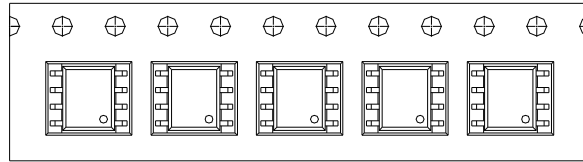

Direction of feed from reel

Tape dimensions

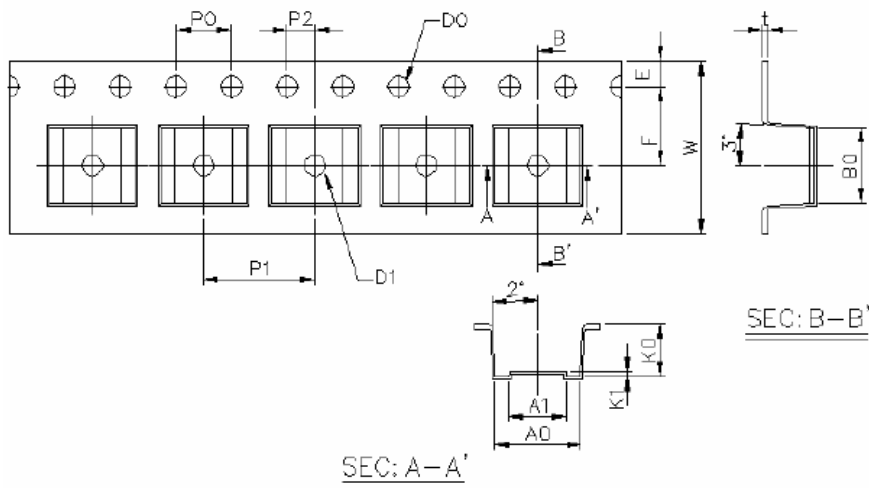

Dimension No.	A0	A1	B0	D0	D1	E	F
Dimension(mm)	6.2±0.1	4.1±0.1	5.28±0.1	1.5±0.1	1.5±0.3	1.75±0.1	5.5±0.1
Dimension No.	Po	P1	P2	t	W	K0	K1
Dimension(mm)	4.0±0.1	8.0±0.1	2.0±0.1	0.4±0.1	12.0+0.3/ -0.1	3.7±0.1	0.3±0.1

Precautions for Use

1. Soldering Condition

1.1 (A) Maximum Body Case Temperature Profile for evaluation of Reflow Profile

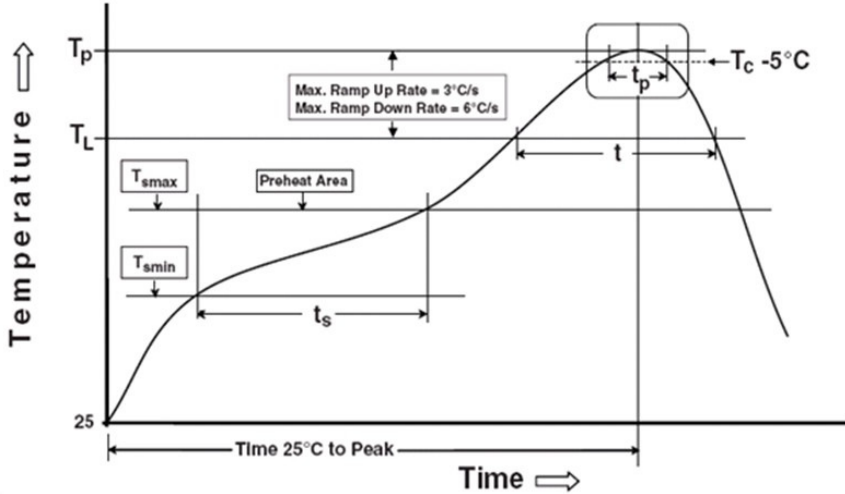

Note:

Reference: IPC/JEDEC J-STD-020D

Preheat

Temperature min (T_{smin})	150 °C
Temperature max (T_{smax})	200 °C
Time (T_{smin} to T_{smax}) (t_s)	60-120 seconds
Average ramp-up rate (T_{smax} to T_p)	3 °C/second max

Other

Liquidus Temperature (T_L)	217 °C
Time above Liquidus Temperature (t_L)	60-100 sec
Peak Temperature (T_p)	260 °C
Time within 5 °C of Actual Peak Temperature: $T_p - 5°C$	30 s
Ramp- Down Rate from Peak Temperature	6 °C /second max.
Time 25 °C to peak temperature	8 minutes max.
Reflow times	3 times

DISCLAIMER

1. Above specification may be changed without notice. EVERLIGHT will reserve authority on material change for above specification.
2. When using this product, please observe the absolute maximum ratings and the instructions for using outlined in these specification sheets. EVERLIGHT assumes no responsibility for any damage resulting from use of the product which does not comply with the absolute maximum ratings and the instructions included in these specification sheets.
3. These specification sheets include materials protected under copyright of EVERLIGHT corporation. Please don't reproduce or cause anyone to reproduce them without EVERLIGHT's consent.