

**850MHz, Low Distortion Current Feedback Operational Amplifiers**

The HFA1100 is a high-speed, wideband, fast settling current feedback amplifier built with Intersil's proprietary complementary bipolar UHF-1 process. It operates with single supply voltages as low as 4.5V (see Application Information section).

The HFA1100 is a basic op amp with uncommitted pins 1, 5, and 8.

This device offers a significant performance improvement over the AD811, AD9617/18, the CLC400-409, and the EL2070, EL2073, EL2030.

**Ordering Information**

PART NUMBER (BRAND)	TEMP. RANGE (°C)	PACKAGE	PKG. DWG. #
HFA1100IP	-40 to 85	8 Ld PDIP	E8.3
HFA1100IB (H1100I)	-40 to 85	8 Ld SOIC	M8.15
HFA1100IB96 (H1100I)	-40 to 85	8 Ld SOIC Tape and Reel	M8.15
HFA1100IBZ (Note) (H1100I)	-40 to 85	8 Ld SOIC (Pb-free)	M8.15
HFA1100IBZ96 (Note) (H1100I)	-40 to 85	8 Ld SOIC Tape and Reel (Pb-free)	M8.15
HFA11XXEVAL	DIP Evaluation Board for High-Speed Op Amps		

NOTE: Intersil Pb-free products employ special Pb-free material sets; molding compounds/die attach materials and 100% matte tin plate termination finish, which are RoHS compliant and compatible with both SnPb and Pb-free soldering operations. Intersil Pb-free products are MSL classified at Pb-free peak reflow temperatures that meet or exceed the Pb-free requirements of IPC/JEDEC J STD-020C.

**The Op Amps with Fastest Edges**

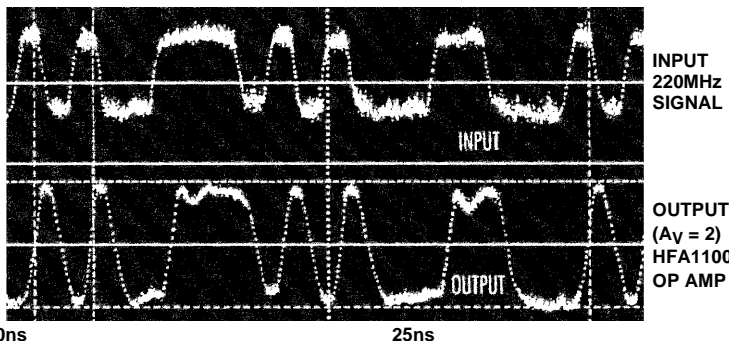

**Features**

- Low Distortion (30MHz, HD2) . . . . . -56dBc
- -3dB Bandwidth . . . . . 850MHz
- Very Fast Slew Rate . . . . . 2300V/μs
- Fast Settling Time (0.1%) . . . . . 11ns
- Excellent Gain Flatness
  - (100MHz) . . . . . ±0.14dB
  - (50MHz) . . . . . ±0.04dB
- High Output Current . . . . . 60mA
- Overdrive Recovery . . . . . <10ns
- Operates with 5V Single Supply (See AN9745)
- Pb-Free Available (RoHS Compliant)

**Applications**

- Video Switching and Routing
- Pulse and Video Amplifiers
- RF/IF Signal Processing
- Flash A/D Driver
- Medical Imaging Systems
- Related Literature
  - AN9420, Current Feedback Theory
  - AN9202, HFA11XX Evaluation Fixture
  - AN9745, Single 5V Supply Operation

**Pinout**

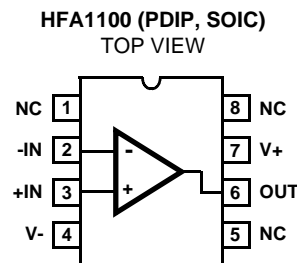

# HFA1100

## Absolute Maximum Ratings $T_A = 25^\circ\text{C}$

Voltage Between $V_+$ and $V_-$ .....	12V
Input Voltage .....	$V_{\text{SUPPLY}}$
Differential Input Voltage .....	5V
Output Current (50% Duty Cycle) .....	60mA

## Operating Conditions

Temperature Range.....  $-40^\circ\text{C}$  to  $85^\circ\text{C}$

## Thermal Information

Thermal Resistance (Typical, Note 1)	$\theta_{JA}$ ( $^\circ\text{C}/\text{W}$ )	$\theta_{JC}$ ( $^\circ\text{C}/\text{W}$ )
PDIP Package .....	130	N/A
SOIC Package .....	170	N/A
Maximum Junction Temperature (Plastic Package) .....	$150^\circ\text{C}$	
Maximum Storage Temperature Range .....	$-65^\circ\text{C}$ to $150^\circ\text{C}$	
Maximum Lead Temperature (Soldering 10s) .....	$300^\circ\text{C}$ (SOIC - Lead Tips Only)	

**CAUTION:** Stresses above those listed in "Absolute Maximum Ratings" may cause permanent damage to the device. This is a stress only rating and operation of the device at these or any other conditions above those indicated in the operational sections of this specification is not implied.

### NOTE:

- $\theta_{JA}$  is measured with the component mounted on an evaluation PC board in free air.

## Electrical Specifications $V_{\text{SUPPLY}} = \pm 5\text{V}$ , $A_V = +1$ , $R_F = 510\Omega$ , $R_L = 100\Omega$ , Unless Otherwise Specified

PARAMETER	TEST CONDITIONS	(NOTE 2) TEST LEVEL	TEMP. ( $^\circ\text{C}$ )	MIN	TYP	MAX	UNITS
<b>INPUT CHARACTERISTICS</b>							
Input Offset Voltage (Note 3)		A	25	-	2	6	mV
		A	Full	-	-	10	mV
Input Offset Voltage Drift		C	Full	-	10	-	$\mu\text{V}/^\circ\text{C}$
$V_{IO}$ CMRR	$\Delta V_{CM} = \pm 2\text{V}$	A	25	40	46	-	dB
		A	Full	38	-	-	dB
$V_{IO}$ PSRR	$\Delta V_S = \pm 1.25\text{V}$	A	25	45	50	-	dB
		A	Full	42	-	-	dB
Non-Inverting Input Bias Current (Note 3)	$+IN = 0\text{V}$	A	25	-	25	40	$\mu\text{A}$
		A	Full	-	-	65	$\mu\text{A}$
$+I_{BIAS}$ Drift		C	Full	-	40	-	$\text{nA}/^\circ\text{C}$
$+I_{BIAS}$ CMS	$\Delta V_{CM} = \pm 2\text{V}$	A	25	-	20	40	$\mu\text{A}/\text{V}$
		A	Full	-	-	50	$\mu\text{A}/\text{V}$
Inverting Input Bias Current (Note 3)	$-IN = 0\text{V}$	A	25	-	12	50	$\mu\text{A}$
		A	Full	-	-	60	$\mu\text{A}$
$-I_{BIAS}$ Drift		C	Full	-	40	-	$\text{nA}/^\circ\text{C}$
$-I_{BIAS}$ CMS	$\Delta V_{CM} = \pm 2\text{V}$	A	25	-	1	7	$\mu\text{A}/\text{V}$
		A	Full	-	-	10	$\mu\text{A}/\text{V}$
$-I_{BIAS}$ PSS	$\Delta V_S = \pm 1.25\text{V}$	A	25	-	6	15	$\mu\text{A}/\text{V}$
		A	Full	-	-	27	$\mu\text{A}/\text{V}$
Non-Inverting Input Resistance		A	25	25	50	-	$\text{k}\Omega$
Inverting Input Resistance		C	25	-	20	30	$\Omega$
Input Capacitance (Either Input)		B	25	-	2	-	pF
Input Common Mode Range		C	Full	$\pm 2.5$	$\pm 3.0$	-	V
Input Noise Voltage (Note 3)	100kHz	B	25	-	4	-	$\text{nV}/\sqrt{\text{Hz}}$
$+I_{\text{Input Noise Current}}$ (Note 3)	100kHz	B	25	-	18	-	$\text{pA}/\sqrt{\text{Hz}}$
$-I_{\text{Input Noise Current}}$ (Note 3)	100kHz	B	25	-	21	-	$\text{pA}/\sqrt{\text{Hz}}$
<b>TRANSFER CHARACTERISTICS</b> $A_V = +2$ , Unless Otherwise Specified							
Open Loop Transimpedance (Note 3)		B	25	-	300	-	$\text{k}\Omega$

# HFA1100

## Electrical Specifications $V_{SUPPLY} = \pm 5V$ , $A_V = +1$ , $R_F = 510\Omega$ , $R_L = 100\Omega$ , Unless Otherwise Specified (Continued)

PARAMETER	TEST CONDITIONS	(NOTE 2) TEST LEVEL	TEMP. (°C)	MIN	TYP	MAX	UNITS
-3dB Bandwidth (Note 3)	$V_{OUT} = 0.2V_{P-P}$ , $A_V = +1$	B	25	530	850	-	MHz
-3dB Bandwidth	$V_{OUT} = 0.2V_{P-P}$ , $A_V = +2$ , $R_F = 360\Omega$	B	25	-	670	-	MHz
Full Power Bandwidth	$V_{OUT} = 4V_{P-P}$ , $A_V = -1$	B	25	-	300	-	MHz
Gain Flatness (Note 3)	To 100MHz	B	25	-	$\pm 0.14$	-	dB
Gain Flatness	To 50MHz	B	25	-	$\pm 0.04$	-	dB
Gain Flatness	To 30MHz	B	25	-	$\pm 0.01$	-	dB
Linear Phase Deviation (Note 3)	DC to 100MHz	B	25	-	0.6	-	Degrees
Differential Gain	NTSC, $R_L = 75\Omega$	B	25	-	0.03	-	%
Differential Phase	NTSC, $R_L = 75\Omega$	B	25	-	0.05	-	Degrees
Minimum Stable Gain		A	Full	1	-	-	V/V
<b>OUTPUT CHARACTERISTICS</b> $A_V = +2$ , Unless Otherwise Specified							
Output Voltage (Note 3)	$A_V = -1$	A	25	$\pm 3.0$	$\pm 3.3$	-	V
		A	Full	$\pm 2.5$	$\pm 3.0$	-	V
Output Current	$R_L = 50\Omega$ , $A_V = -1$	A	25, 85	50	60	-	mA
		A	-40	35	50	-	mA
DC Closed Loop Output Impedance (Note 3)		B	25	-	0.07	-	$\Omega$
2nd Harmonic Distortion (Note 3)	30MHz, $V_{OUT} = 2V_{P-P}$	B	25	-	-56	-	dBc
3rd Harmonic Distortion (Note 3)	30MHz, $V_{OUT} = 2V_{P-P}$	B	25	-	-80	-	dBc
3rd Order Intercept (Note 3)	100MHz	B	25	20	30	-	dBm
1dB Compression	100MHz	B	25	15	20	-	dBm
<b>TRANSIENT RESPONSE</b> $A_V = +2$ , Unless Otherwise Specified							
Rise Time	$V_{OUT} = 2.0V$ Step	B	25	-	900	-	ps
Overshoot (Note 3)	$V_{OUT} = 2.0V$ Step	B	25	-	10	-	%
Slew Rate	$A_V = +1$ , $V_{OUT} = 5V_{P-P}$	B	25	-	1400	-	V/ $\mu$ s
Slew Rate	$A_V = +2$ , $V_{OUT} = 5V_{P-P}$	B	25	1850	2300	-	V/ $\mu$ s
0.1% Settling (Note 3)	$V_{OUT} = 2V$ to $0V$	B	25	-	11	-	ns
0.2% Settling (Note 3)	$V_{OUT} = 2V$ to $0V$	B	25	-	7	-	ns
Overdrive Recovery Time	2X Overdrive	B	25	-	7.5	10	ns
<b>POWER SUPPLY CHARACTERISTICS</b>							
Supply Voltage Range		B	Full	$\pm 4.5$	-	$\pm 5.5$	V
Supply Current (Note 3)		A	25	-	21	26	mA
		A	Full	-	-	33	mA

**NOTES:**

2. Test Level: A. Production Tested; B. Typical or Guaranteed Limit Based on Characterization; C. Design Typical for Information Only.
3. See Typical Performance Curves for more information.

**Application Information**

**Optimum Feedback Resistor ( $R_F$ )**

The enclosed plots of inverting and non-inverting frequency response detail the performance of the HFA1100 in various gains. Although the bandwidth dependency on  $A_{CL}$  isn't as severe as that of a voltage feedback amplifier, there is an appreciable decrease in bandwidth at higher gains. This decrease can be minimized by taking advantage of the current feedback amplifier's unique relationship between bandwidth and  $R_F$ . All current feedback amplifiers require a feedback resistor, even for unity gain applications, and the  $R_F$ , in conjunction with the internal compensation capacitor, sets the dominant pole of the frequency response. Thus, the amplifier's bandwidth is inversely proportional to  $R_F$ . The HFA1100 design is optimized for a 510 $\Omega$   $R_F$ , at a gain of +1. Decreasing  $R_F$  in a unity gain application decreases stability, resulting in excessive peaking and overshoot (Note: Capacitive feedback causes the same problems due to the feedback impedance decrease at higher frequencies). At higher gains the amplifier is more stable, so  $R_F$  can be decreased in a trade-off of stability for bandwidth. The table below lists recommended  $R_F$  values for various gains, and the expected bandwidth.

$A_{CL}$	$R_F$ ( $\Omega$ )	BW (MHz)
+1	510	850
-1	430	580
+2	360	670
+5	150	520
+10	180	240
+19	270	125

**5V Single Supply Operation**

This amplifier operates at single supply voltages down to 4.5V. The table below details the amplifier's performance with a single 5V supply. The dramatic supply current reduction at this operating condition (refer also to Figure 23) makes these op amps even better choices for low power 5V systems. Refer to Application Note AN9745 for further information.

PARAMETER	TYP
Input Common Mode Range	1V to 4V
-3dB BW ( $A_V = +2$ )	267MHz
Gain Flatness (to 50MHz, $A_V = +2$ )	0.05dB
Output Voltage ( $A_V = -1$ )	1.3V to 3.8V
Slew Rate ( $A_V = +2$ )	475V/ $\mu$ s
0.1% Settling Time	17ns
Supply Current	5.5mA

**Use of Die in Hybrid Applications**

This amplifier is designed with compensation to negate the package parasitics that typically lead to instabilities. As a result, the use of die in hybrid applications results in overcompensated performance due to lower parasitic capacitances. Reducing  $R_F$  below the recommended values for packaged units will solve the problem. For  $A_V = +2$  the recommended starting point is 300 $\Omega$ , while unity gain applications should try 400 $\Omega$ .

**PC Board Layout**

The frequency performance of this amplifier depends a great deal on the amount of care taken in designing the PC board. **The use of low inductance components such as chip resistors and chip capacitors is strongly recommended, while a solid ground plane is a must!**

Attention should be given to decoupling the power supplies. A large value (10 $\mu$ F) tantalum in parallel with a small value chip (0.1 $\mu$ F) capacitor works well in most cases.

Terminated microstrip signal lines are recommended at the input and output of the device. Output capacitance, such as that resulting from an improperly terminated transmission line will degrade the frequency response of the amplifier and may cause oscillations. In most cases, the oscillation can be avoided by placing a resistor in series with the output.

Care must also be taken to minimize the capacitance to ground seen by the amplifier's inverting input. The larger this capacitance, the worse the gain peaking, resulting in pulse overshoot and possible instability. To this end, it is recommended that the ground plane be removed under traces connected to pin 2, and connections to pin 2 should be kept as short as possible.

An example of a good high frequency layout is the Evaluation Board shown below.

**Evaluation Board**

An evaluation board is available for the HFA1100 (Part Number HFA11XXEVAL). Please contact your local sales office for information.

The layout and schematic of the board are shown below:

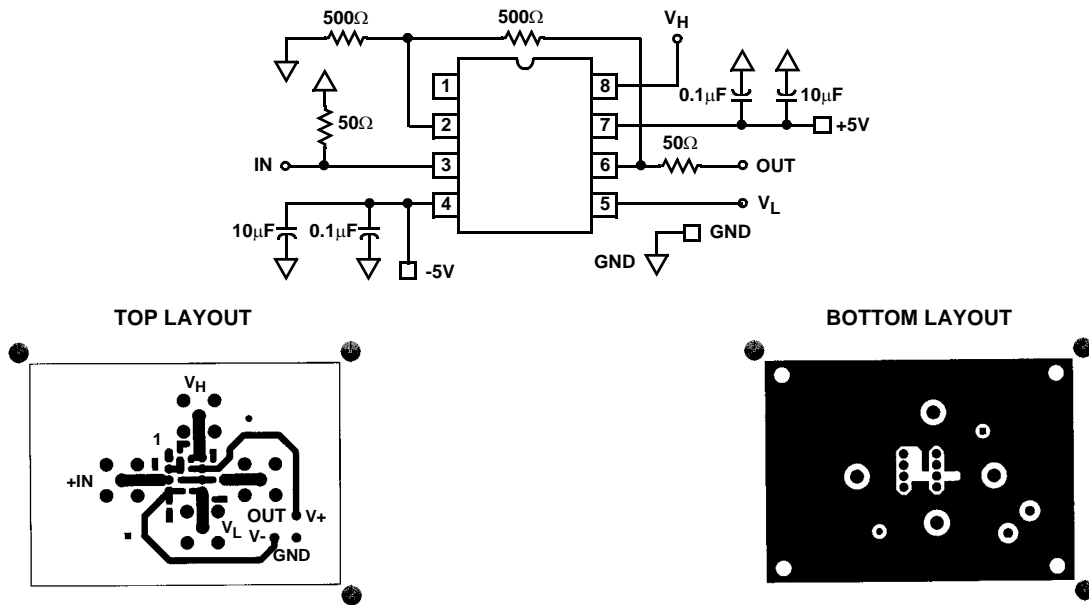

**Typical Performance Curves**  $V_{SUPPLY} = \pm 5V$ ,  $R_F = 510\Omega$ ,  $T_A = 25^\circ C$ ,  $R_L = 100\Omega$ , Unless Otherwise Specified

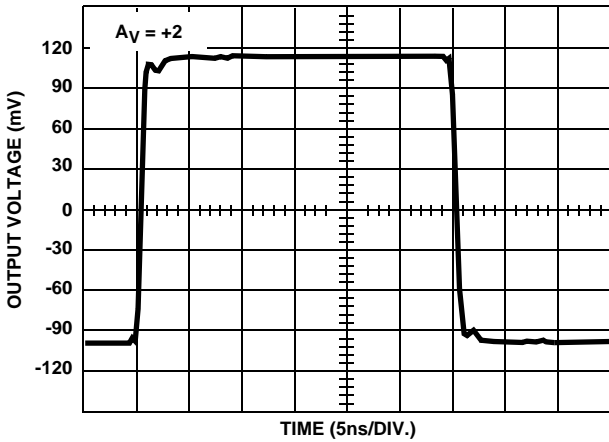

FIGURE 1. SMALL SIGNAL PULSE

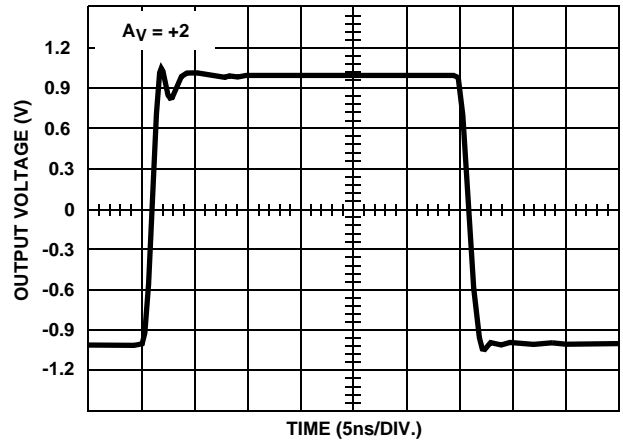

FIGURE 2. LARGE SIGNAL PULSE

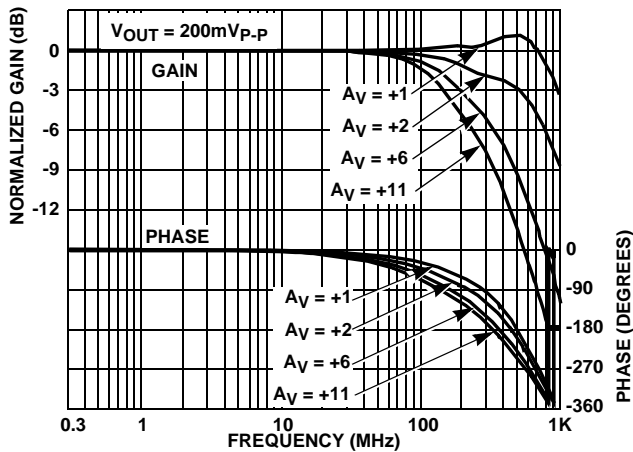

FIGURE 3. NON-INVERTING FREQUENCY RESPONSE

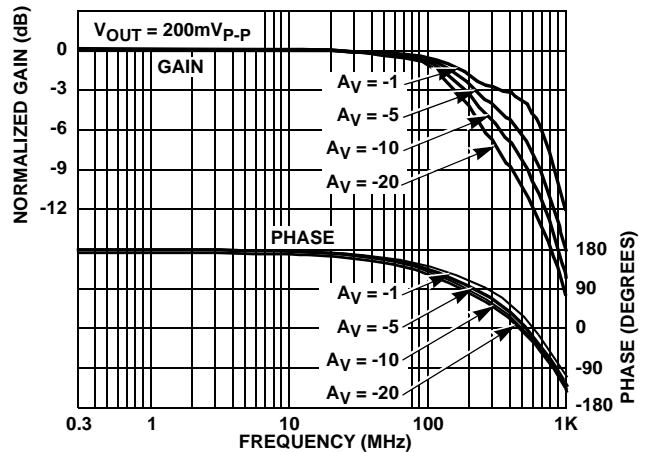

FIGURE 4. INVERTING FREQUENCY RESPONSE

**Typical Performance Curves**  $V_{SUPPLY} = \pm 5V$ ,  $R_F = 510\Omega$ ,  $T_A = 25^\circ C$ ,  $R_L = 100\Omega$ , Unless Otherwise Specified (Continued)

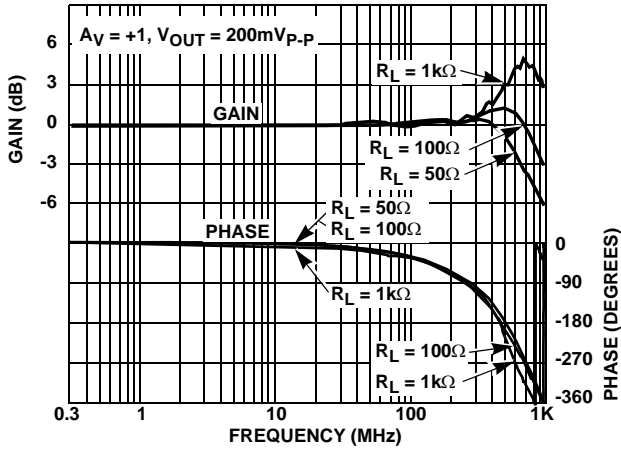

FIGURE 5. FREQUENCY RESPONSE FOR VARIOUS LOAD RESISTORS

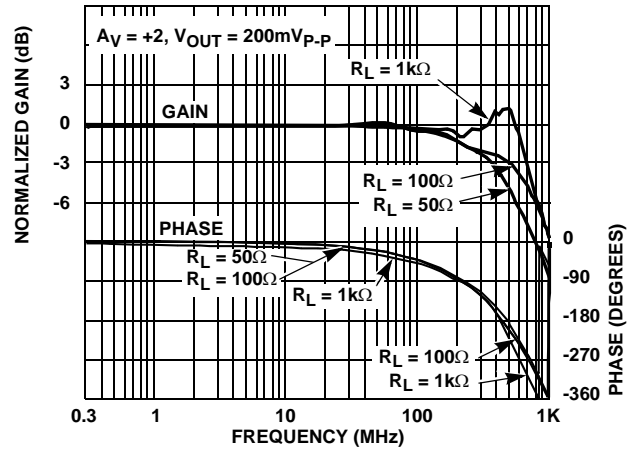

FIGURE 6. FREQUENCY RESPONSE FOR VARIOUS LOAD RESISTORS

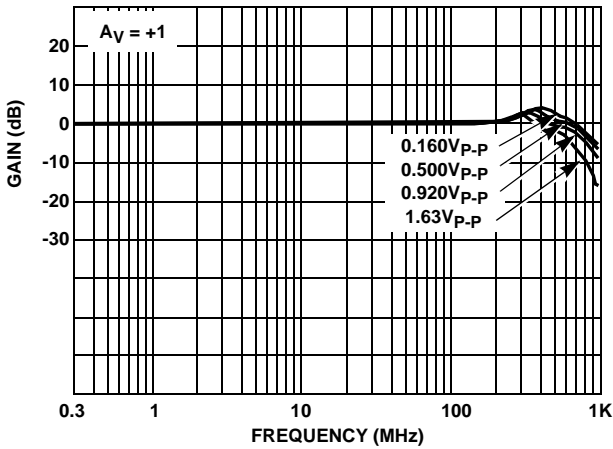

FIGURE 7. FREQUENCY RESPONSE FOR VARIOUS OUTPUT VOLTAGES

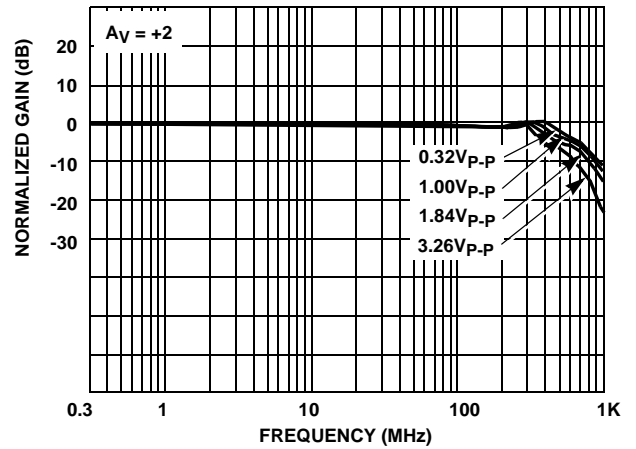

FIGURE 8. FREQUENCY RESPONSE FOR VARIOUS OUTPUT VOLTAGES

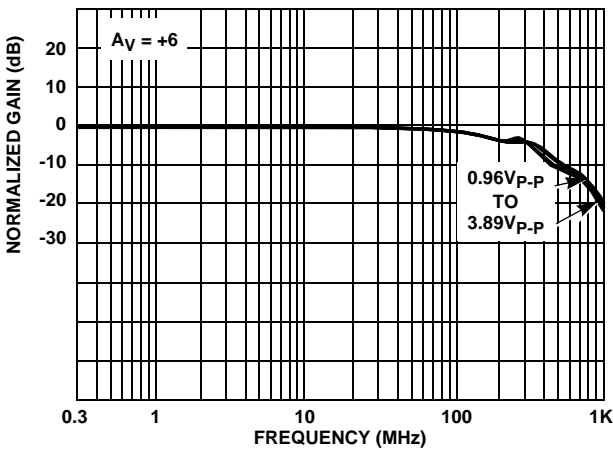

FIGURE 9. FREQUENCY RESPONSE FOR VARIOUS OUTPUT VOLTAGES

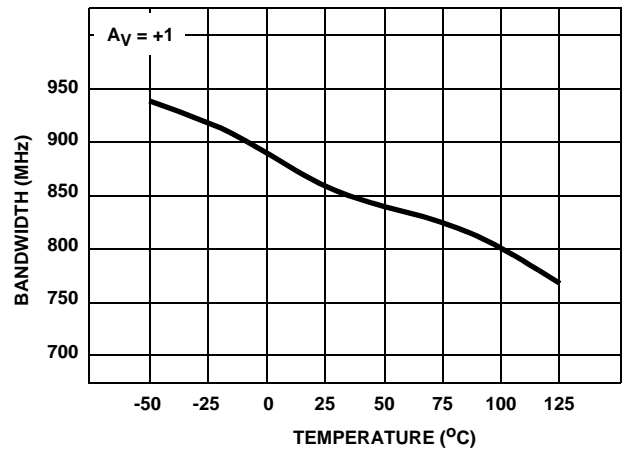

FIGURE 10. -3dB BANDWIDTH vs TEMPERATURE

**Typical Performance Curves**  $V_{SUPPLY} = \pm 5V$ ,  $R_F = 510\Omega$ ,  $T_A = 25^\circ C$ ,  $R_L = 100\Omega$ , Unless Otherwise Specified (Continued)

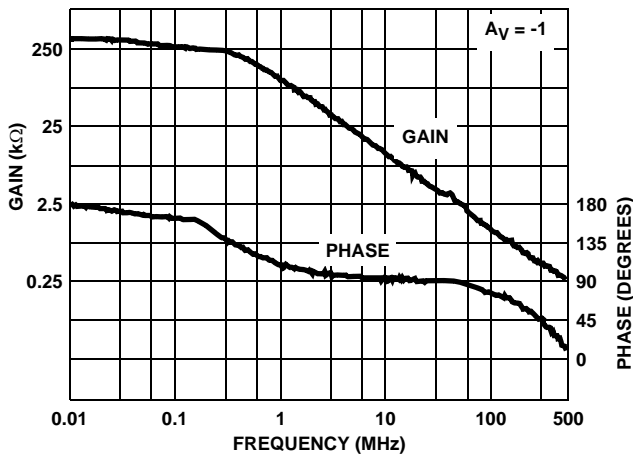

FIGURE 11. OPEN LOOP TRANSIMPEDANCE

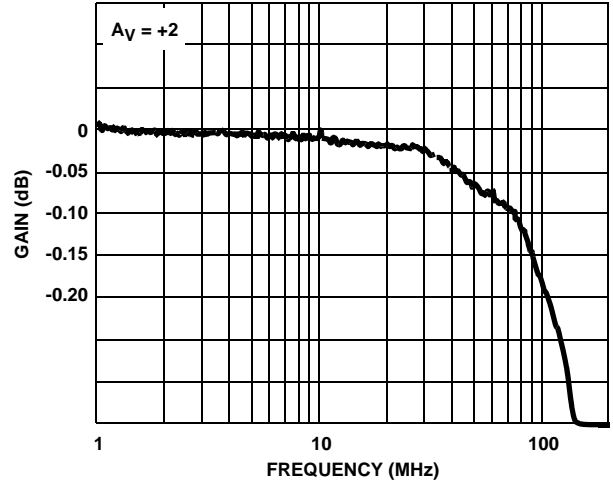

FIGURE 12. GAIN FLATNESS

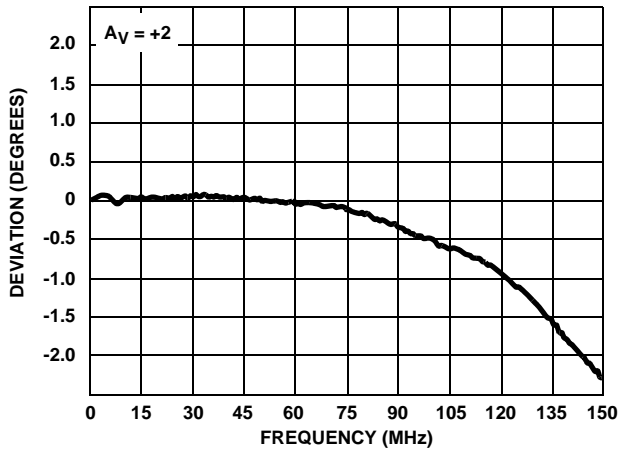

FIGURE 13. DEVIATION FROM LINEAR PHASE

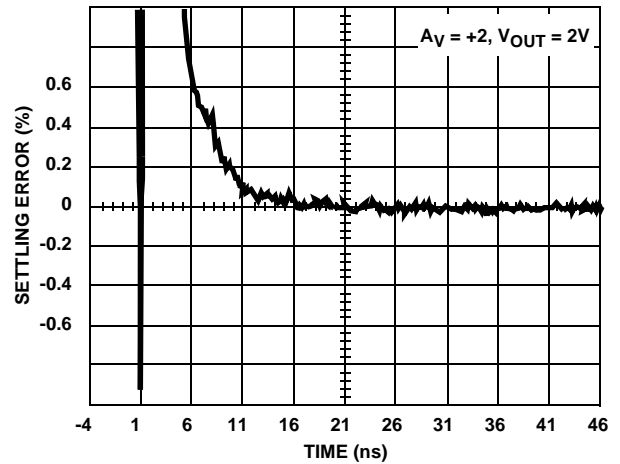

FIGURE 14. SETTLING RESPONSE

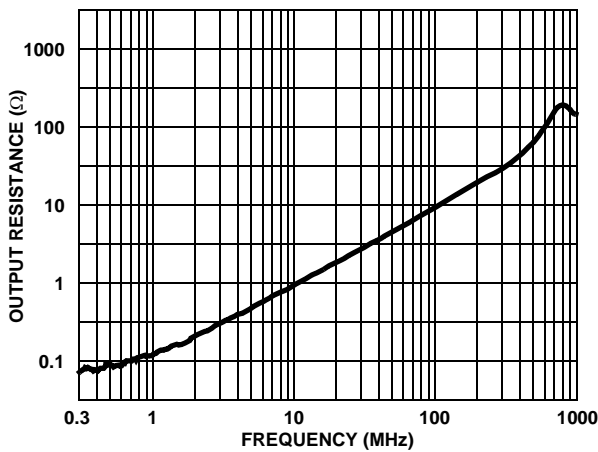

FIGURE 15. CLOSED LOOP OUTPUT RESISTANCE

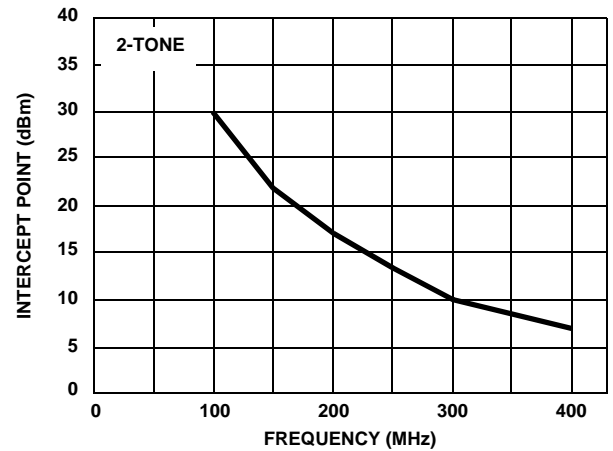

FIGURE 16. 3rd ORDER INTERMODULATION INTERCEPT

**Typical Performance Curves**  $V_{SUPPLY} = \pm 5V$ ,  $R_F = 510\Omega$ ,  $T_A = 25^\circ C$ ,  $R_L = 100\Omega$ , Unless Otherwise Specified (Continued)

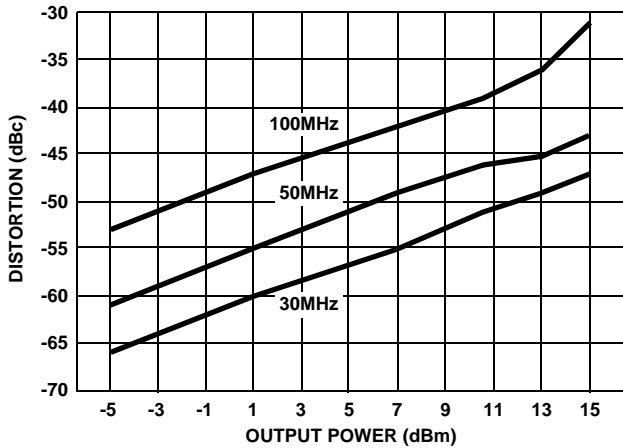

FIGURE 17. 2nd HARMONIC DISTORTION vs  $P_{OUT}$

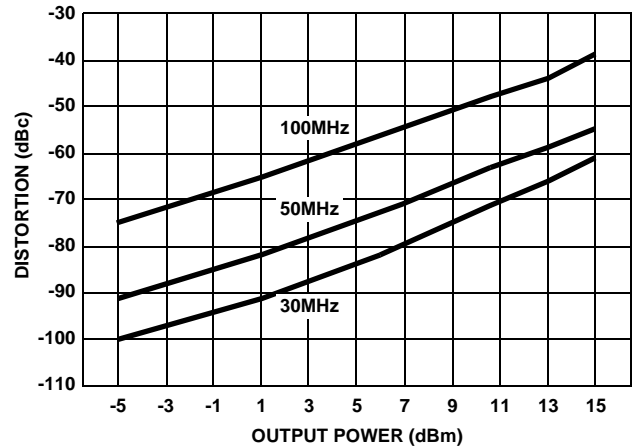

FIGURE 18. 3rd HARMONIC DISTORTION vs  $P_{OUT}$

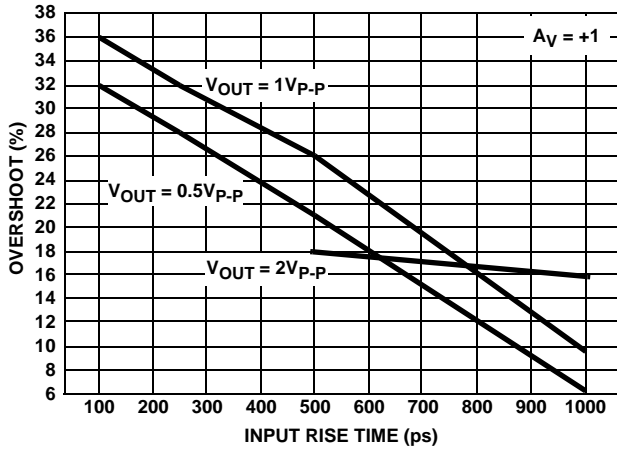

FIGURE 19. OVERSHOOT vs INPUT RISE TIME

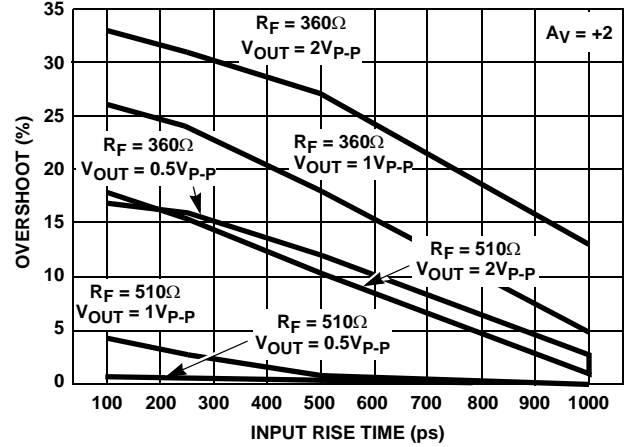

FIGURE 20. OVERSHOOT vs INPUT RISE TIME

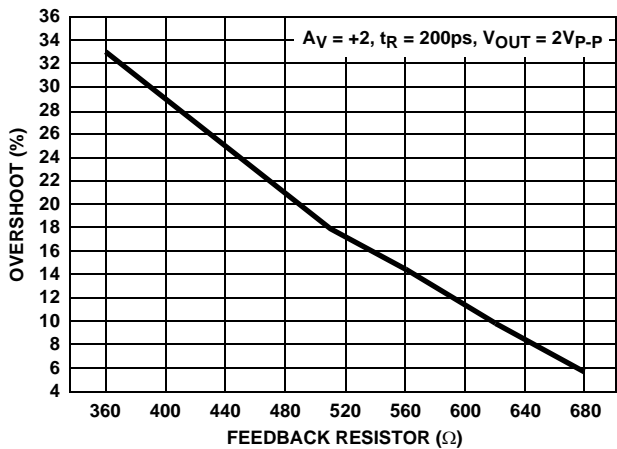

FIGURE 21. OVERSHOOT vs FEEDBACK RESISTOR

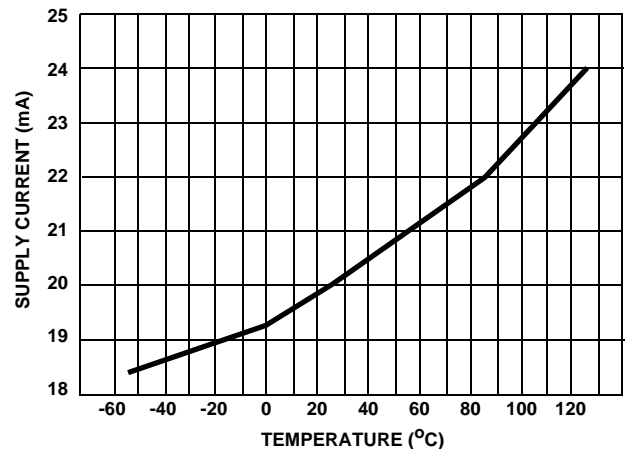

FIGURE 22. SUPPLY CURRENT vs TEMPERATURE



**Typical Performance Curves**  $V_{SUPPLY} = \pm 5V$ ,  $R_F = 510\Omega$ ,  $T_A = 25^\circ C$ ,  $R_L = 100\Omega$ , Unless Otherwise Specified (Continued)

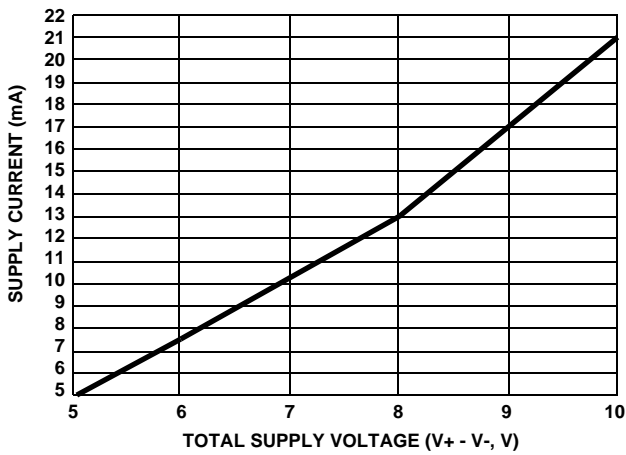

FIGURE 23. SUPPLY CURRENT vs SUPPLY VOLTAGE

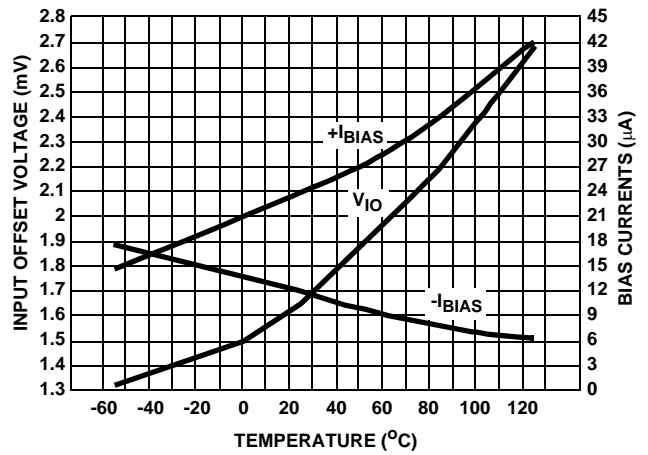

FIGURE 24.  $V_{IO}$  AND BIAS CURRENTS vs TEMPERATURE

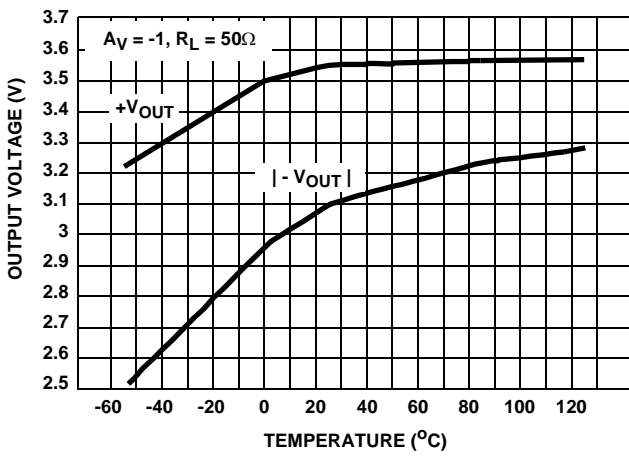

FIGURE 25. OUTPUT VOLTAGE vs TEMPERATURE

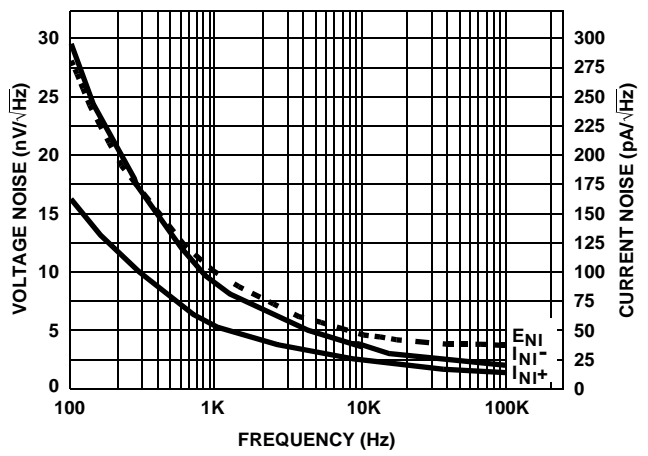

FIGURE 26. INPUT NOISE vs FREQUENCY

**Die Characteristics**

**DIE DIMENSIONS:**

63 mils x 44 mils x 19 mils  
 1600 $\mu$ m x 1130 $\mu$ m

**METALLIZATION:**

Type: Metal 1: AlCu (2%)/TiW  
 Thickness: Metal 1: 8k $\text{\AA}$   $\pm$ 0.4k $\text{\AA}$   
 Type: Metal 2: AlCu (2%)  
 Thickness: Metal 2: 16k $\text{\AA}$   $\pm$ 0.8k $\text{\AA}$

**PASSIVATION:**

Type: Nitride  
 Thickness: 4k $\text{\AA}$   $\pm$ 0.5k $\text{\AA}$

**TRANSISTOR COUNT:**

52

**SUBSTRATE POTENTIAL (POWERED UP):**

Floating (Recommend Connection to V-)

**Metallization Mask Layout**

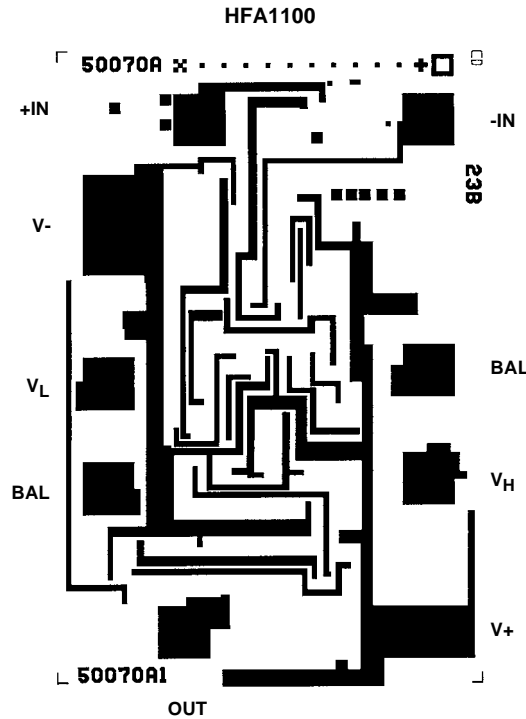

All Intersil U.S. products are manufactured, assembled and tested utilizing ISO9000 quality systems.  
 Intersil Corporation's quality certifications can be viewed at [www.intersil.com/design/quality](http://www.intersil.com/design/quality)

*Intersil products are sold by description only. Intersil Corporation reserves the right to make changes in circuit design, software and/or specifications at any time without notice. Accordingly, the reader is cautioned to verify that data sheets are current before placing orders. Information furnished by Intersil is believed to be accurate and reliable. However, no responsibility is assumed by Intersil or its subsidiaries for its use; nor for any infringements of patents or other rights of third parties which may result from its use. No license is granted by implication or otherwise under any patent or patent rights of Intersil or its subsidiaries.*

For information regarding Intersil Corporation and its products, see [www.intersil.com](http://www.intersil.com)