

Specifications:

Sound level Category	Medium Sound Level
Mode of Operation	Fast Pulse
Mounting	Panel (see note B)
Voltage Rating	10 to 48 Vac/dc
Frequency	1900 Hz ±300 Hz
Loudness (Min. Voltage)	60 dB(A) min. @ 2 FT and 10 Vac/dc
Loudness (Max Voltage)	75 dB(A) min. @ 2FT and 48 Vac/dc
Current Draw	4 mA Max @ 10 Vac/dc
Current Draw	20 mA Max @ 48 Vac/dc
Min. Pulse Rate (PPS)	2 @ 10 Vac/dc
Max. Pulse Rate (PPS)	10 @ 48 Vac/dc
Duty Cycle (%)	50 (Approx)
Storage Temperature	-40°C to +85°C
Operating Temperature	-30°C to +65°C
Weight (Typical)	2.1 oz (60 g)
Housing	6/6 Nylon, Color Black
Options	For other options contact factory

Dimensions: Inches (mm)

PART DIMENSIONS BEFORE CODE DATE 0810 5

PART DIMENSIONS AFTER CODE DATE 0811 1

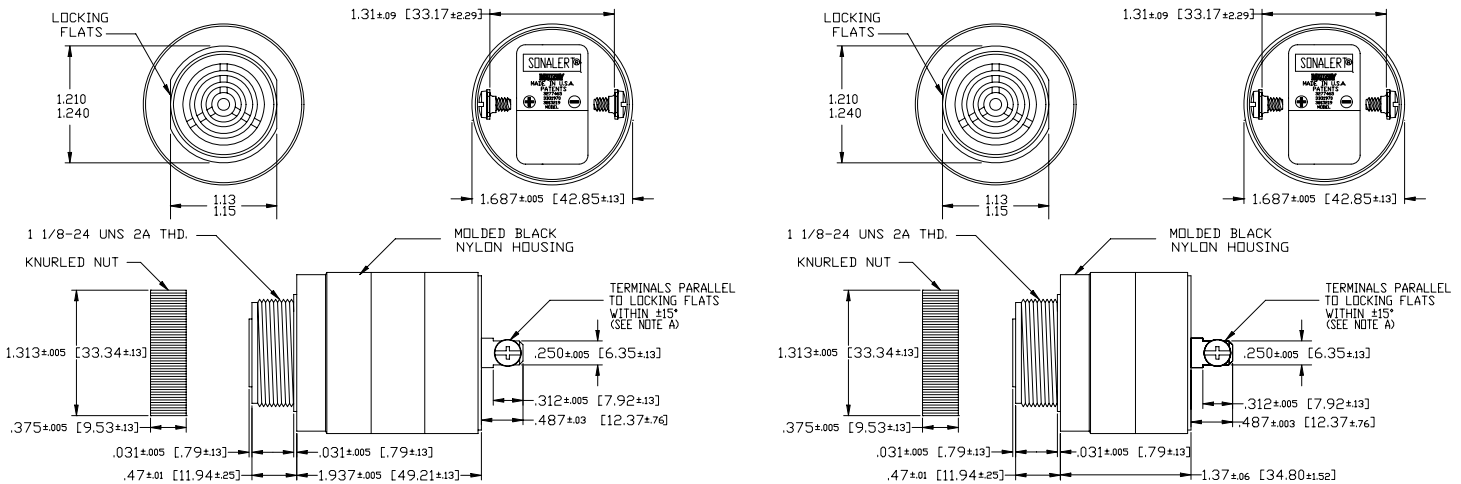

NOTE A: TERMINALS--032 BRASS TIN PLATED, TAPPED FOR #6-32 SCREW, TWO #6-32 NICKEL PLATED BRASS SCREWS INCLUDED. WILL ACCEPT 1/4" QUICK CONNECT.

NOTE B: MOUNTING-- REMOVE BLACK PLASTIC NUT AND INSERT THREADED FRONT THROUGH 125" HOLE PUNCHED IN PANEL, IF ORIENTATION IS NEEDED, NOTE LOCKING FLATS ON DRAWING. SCREW NUT BACK ON. DO NOT OVERTIGHTEN.

NOTE A: TERMINALS--032 BRASS TIN PLATED, TAPPED FOR #6-32 SCREW, TWO #6-32 NICKEL PLATED BRASS SCREWS INCLUDED. WILL ACCEPT 1/4" QUICK CONNECT.

NOTE B: MOUNTING-- REMOVE BLACK PLASTIC NUT AND INSERT THREADED FRONT THROUGH 125" HOLE PUNCHED IN PANEL, IF ORIENTATION IS NEEDED, NOTE LOCKING FLATS ON DRAWING. SCREW NUT BACK ON. DO NOT OVERTIGHTEN.