

CMUDM8005
SURFACE MOUNT SILICON
P-CHANNEL
ENHANCEMENT-MODE
MOSFET

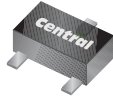

SOT-523 CASE



www.centrasemi.com

DESCRIPTION:

The CENTRAL SEMICONDUCTOR CMUDM8005 is an enhancement-mode P-Channel MOSFET, manufactured by the P-Channel DMOS process, designed for high speed pulsed amplifier and driver applications. This MOSFET offers low $r_{DS(ON)}$ and low threshold voltage.

MARKING CODE: 5C8

FEATURES:

- ESD protection up to 1800V (Human Body Model)
- 300mW power dissipation
- Very low $r_{DS(ON)}$
- Low threshold voltage
- Logic level compatible
- Small, SOT-523 surface mount package

APPLICATIONS:

- Load/Power switches
- Power supply converter circuits
- Battery powered portable equipment

MAXIMUM RATINGS: ($T_A=25^\circ\text{C}$)

	SYMBOL		UNITS
Drain-Source Voltage	V_{DS}	20	V
Gate-Source Voltage	V_{GS}	8.0	V
Continuous Drain Current (Steady State - Note 1)	I_D	650	mA
Continuous Source Current (Body Diode)	I_S	250	mA
Maximum Pulsed Drain Current	I_{DM}	1.0	A
Power Dissipation (Note 1)	P_D	300	mW
Operating and Storage Junction Temperature	T_J, T_{stg}	-65 to +150	$^\circ\text{C}$

ELECTRICAL CHARACTERISTICS: ($T_A=25^\circ\text{C}$ unless otherwise noted)

SYMBOL	TEST CONDITIONS	MIN	TYP	MAX	UNITS
I_{GSSF}, I_{GSSR}	$V_{GS}=4.5V, V_{DS}=0$			10	μA
I_{DSS}	$V_{DS}=16V, V_{GS}=0$			100	nA
BV_{DSS}	$V_{GS}=0, I_D=250\mu\text{A}$	20			V
$V_{GS(th)}$	$V_{DS}=V_{GS}, I_D=250\mu\text{A}$	0.5		1.0	V
V_{SD}	$V_{GS}=0, I_S=250\text{mA}$			1.1	V
$r_{DS(ON)}$	$V_{GS}=4.5V, I_D=350\text{mA}$		0.25	0.36	Ω
$r_{DS(ON)}$	$V_{GS}=2.5V, I_D=300\text{mA}$		0.37	0.5	Ω
$r_{DS(ON)}$	$V_{GS}=1.8V, I_D=150\text{mA}$			0.8	Ω
g_{FS}	$V_{DS}=10V, I_D=200\text{mA}$	0.2			S
C_{rSS}	$V_{DS}=16V, V_{GS}=0, f=1.0\text{MHz}$		25		pF
C_{iSS}	$V_{DS}=16V, V_{GS}=0, f=1.0\text{MHz}$		100		pF
C_{OSS}	$V_{DS}=16V, V_{GS}=0, f=1.0\text{MHz}$		21		pF

Notes: (1) Mounted on 2 inch square FR-4 PCB with copper mounting pad area of 1.13in²

R4 (5-June 2013)

CMUDM8005

**SURFACE MOUNT SILICON
P-CHANNEL
ENHANCEMENT-MODE
MOSFET**



ELECTRICAL CHARACTERISTICS - Continued: ($T_A=25^\circ\text{C}$ unless otherwise noted)

SYMBOL	TEST CONDITIONS	MIN	TYP	UNITS
$Q_{g(\text{tot})}$	$V_{DS}=10\text{V}, V_{GS}=4.5\text{V}, I_D=200\text{mA}$		1.2	nC
Q_{gs}	$V_{DS}=10\text{V}, V_{GS}=4.5\text{V}, I_D=200\text{mA}$		0.24	nC
Q_{gd}	$V_{DS}=10\text{V}, V_{GS}=4.5\text{V}, I_D=200\text{mA}$		0.36	nC
t_{on}	$V_{DD}=10\text{V}, V_{GS}=4.5\text{V}, I_D=200\text{mA}, R_G=10\Omega$		38	ns
t_{off}	$V_{DD}=10\text{V}, V_{GS}=4.5\text{V}, I_D=200\text{mA}, R_G=10\Omega$		48	ns

SOT-523 CASE - MECHANICAL OUTLINE

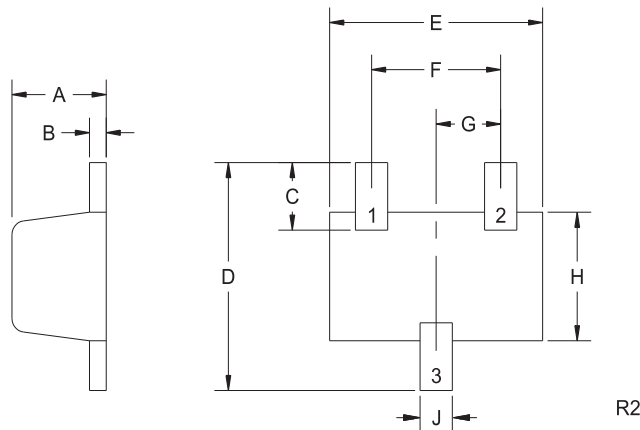

**PIN CONFIGURATION
(Bottom View)**

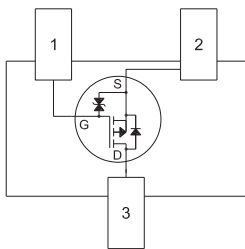

LEAD CODE:

- 1) Gate
- 2) Source
- 3) Drain

MARKING CODE: 5C8

SYMBOL	DIMENSIONS			
	INCHES		MILLIMETERS	
	MIN	MAX	MIN	MAX
A	0.023	0.031	0.58	0.78
B	0.002	0.008	0.04	0.20
C	0.013	0.021	0.34	0.54
D	0.059	0.067	1.50	1.70
E	0.059	0.067	1.50	1.70
F	0.035	0.043	0.90	1.10
G	0.020		0.50	
H	0.031	0.039	0.78	0.98
J	0.010	0.014	0.25	0.35

SOT-523 (REV: R2)

R4 (5-June 2013)

CMUDM8005
SURFACE MOUNT SILICON
P-CHANNEL
ENHANCEMENT-MODE
MOSFET



TYPICAL ELECTRICAL CHARACTERISTICS

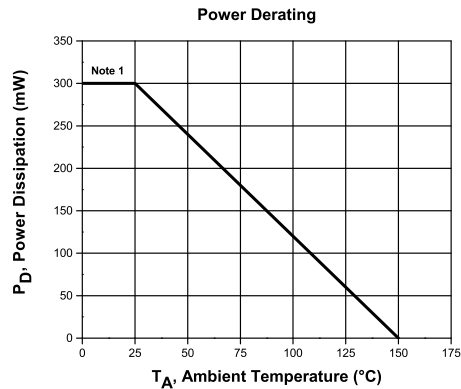
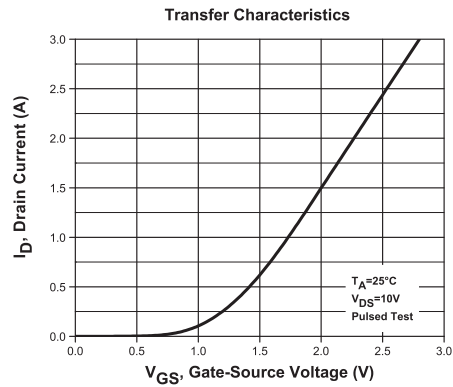
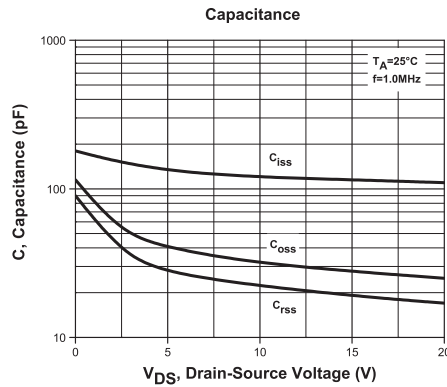
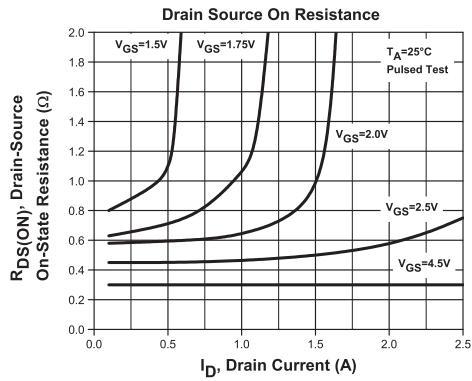
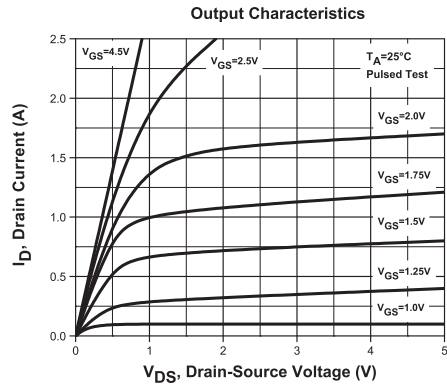

R4 (5-June 2013)

OUTSTANDING SUPPORT AND SUPERIOR SERVICES



PRODUCT SUPPORT

Central's operations team provides the highest level of support to insure product is delivered on-time.

- Supply management (Customer portals)
- Inventory bonding
- Consolidated shipping options
- Custom bar coding for shipments
- Custom product packing

DESIGNER SUPPORT/SERVICES

Central's applications engineering team is ready to discuss your design challenges. Just ask.

- Free quick ship samples (2nd day air)
- Online technical data and parametric search
- SPICE models
- Custom electrical curves
- Environmental regulation compliance
- Customer specific screening
- Up-screening capabilities
- Special wafer diffusions
- PbSn plating options
- Package details
- Application notes
- Application and design sample kits
- Custom product and package development

CONTACT US

Corporate Headquarters & Customer Support Team

Central Semiconductor Corp.
145 Adams Avenue
Hauppauge, NY 11788 USA
Main Tel: (631) 435-1110
Main Fax: (631) 435-1824
Support Team Fax: (631) 435-3388
www.centalsemi.com

Worldwide Field Representatives:
www.centalsemi.com/wwreps

Worldwide Distributors:
www.centalsemi.com/wwdistributors

For the latest version of Central Semiconductor's **LIMITATIONS AND DAMAGES DISCLAIMER**, which is part of Central's Standard Terms and Conditions of sale, visit: www.centalsemi.com/terms