

□

Breadboards for Beginners

Created by lady ada

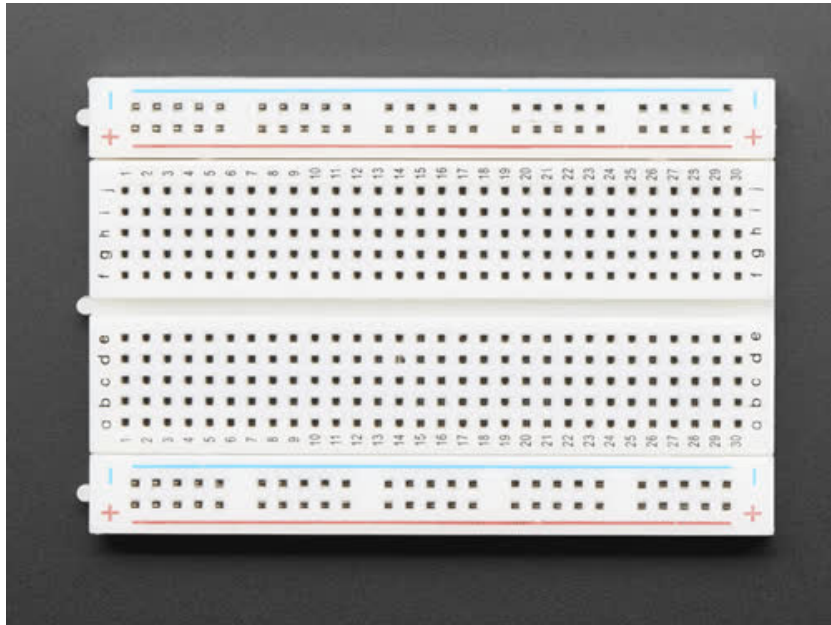

Last updated on 2016-09-07 03:56:44 PM UTC

Guide Contents

Guide Contents	2
Introduction	3
What's up with the name?	5
~~ Interlude ~~ (Wire Wrapping)	6
1971 - The Breadboard Is Invented!	7
Breadboards	9
The curse of the flaky breadboard	13
Other Breadboard Sizes	14
Half Size	14
Tiny Breadboard	15
Little Breadboard Bits	17
Large Breadboard	20
Breadboard Usage	22
Adding DIPs and Modules	24
Jumper Wires	27
DIY Solid Core Wire Jumpers	27
Multi-size wire stripper & cutter	27
Hook-up Wire Spool Set - 22AWG Solid Core - 6 x 25 ft	28
Pre-made Jumper Wires	33
Premium Male/Male Jumper Wires - 40 x 3" (75mm)	33
Premium Male/Male Jumper Wires - 40 x 6" (150mm)	34
Premium Male/Male Jumper Wires - 40 x 12" (300mm)	34
Perma Protos	36
Adafruit Perma-Proto Quarter-sized Breadboard PCB - Single	40
Adafruit Perma-Proto Full-sized Breadboard PCB - Single	40
Adafruit Perma-Proto Mint Tin Size Breadboard PCB	41
Adafruit Perma-Proto Small Mint Tin Size Breadboard PCB - 3 pack	41
Breadboard Tips & Tricks	43
Connecting the two power rails	43
Watch Out For Split Rails!	44
Using Fritzing!	45

Introduction

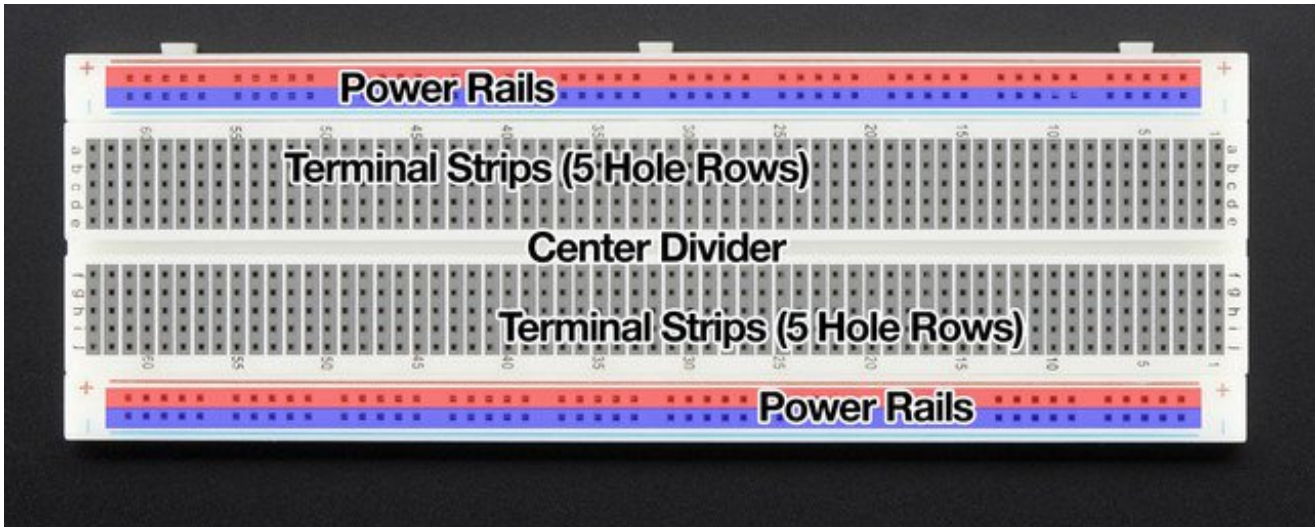

When you start on your electronics journey, you will eventually need to wire up some parts to follow along with some project. And, chances are, you will be prodded towards using a **breadboard**. These ubiquitous pale slabs of plastic are *everywhere* when it comes to electronics hacking.

Their popularity is not surprising - they are like a cutting board is to a cook, or a sewing machine to a tailor: indispensable, multi-purpose, durable, and inexpensive!

Just about every beginner kit contains one, and almost all projects make use of one! Heck, I would not be surprised if you already had one sitting on your work desk. Perhaps that's why you are reading this guide?

Well you are in luck because we will be spending this tutorial on *just* breadboards, with diagrams, tips and tricks to take you from **beginner** to **brilliant**

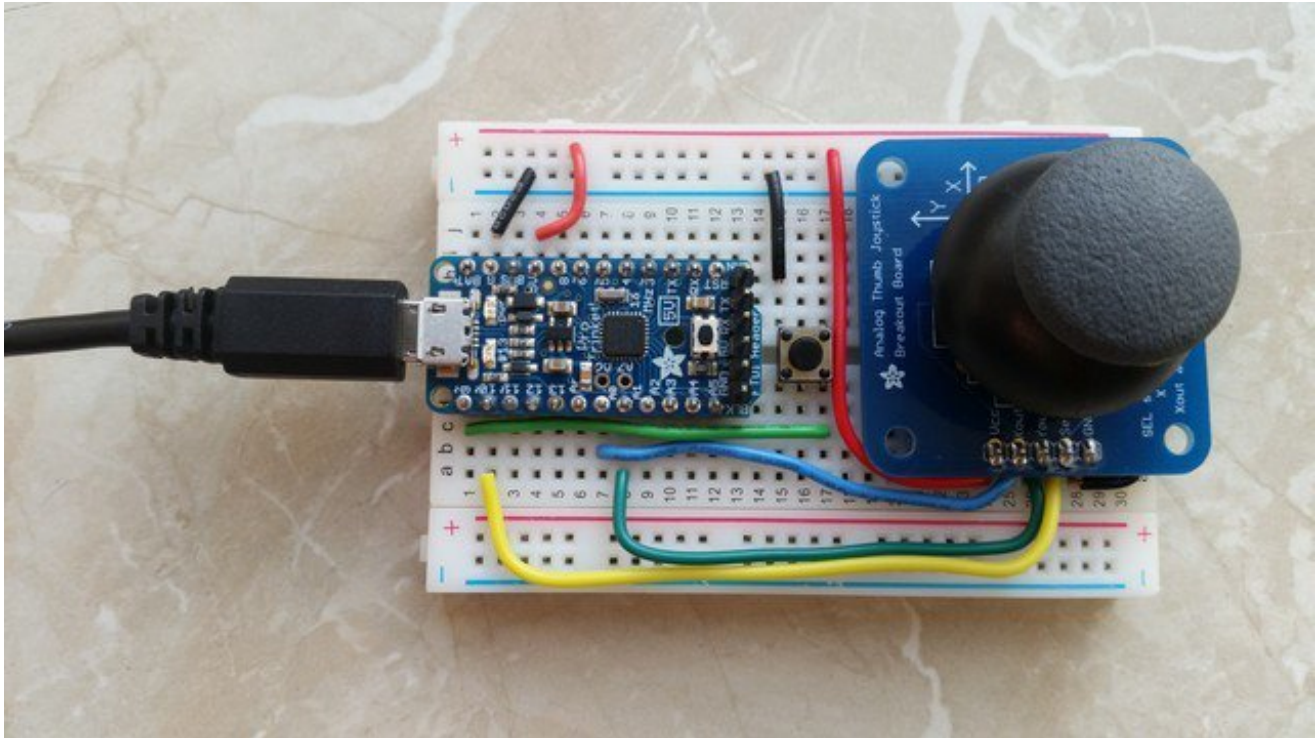

[Trinket joystick by Mike Barela \(http://adafru.it/rd5\)](http://adafru.it/rd5)

What's up with the name?

You are probably wondering how on earth a piece of plastic that fits in your hand relates to the large slab of wood used to bake or cut bread.



Image by Culinary Geek (<http://adafru.it/rdc>)

A good question! It turns out that many many years ago, for engineers working on electronics before 1970 they did not the thing we call a **solderless breadboard**. Instead, they would build electronics by *literally* hammering nails into a *wooden board* - sometimes it was also literally a bread board but usually just a plank purchased from a hardware store.

Once it was cut to the right size, the electronic parts would be nailed or glued to the board and electrical connections made by soldering or wrapping wire around the nails

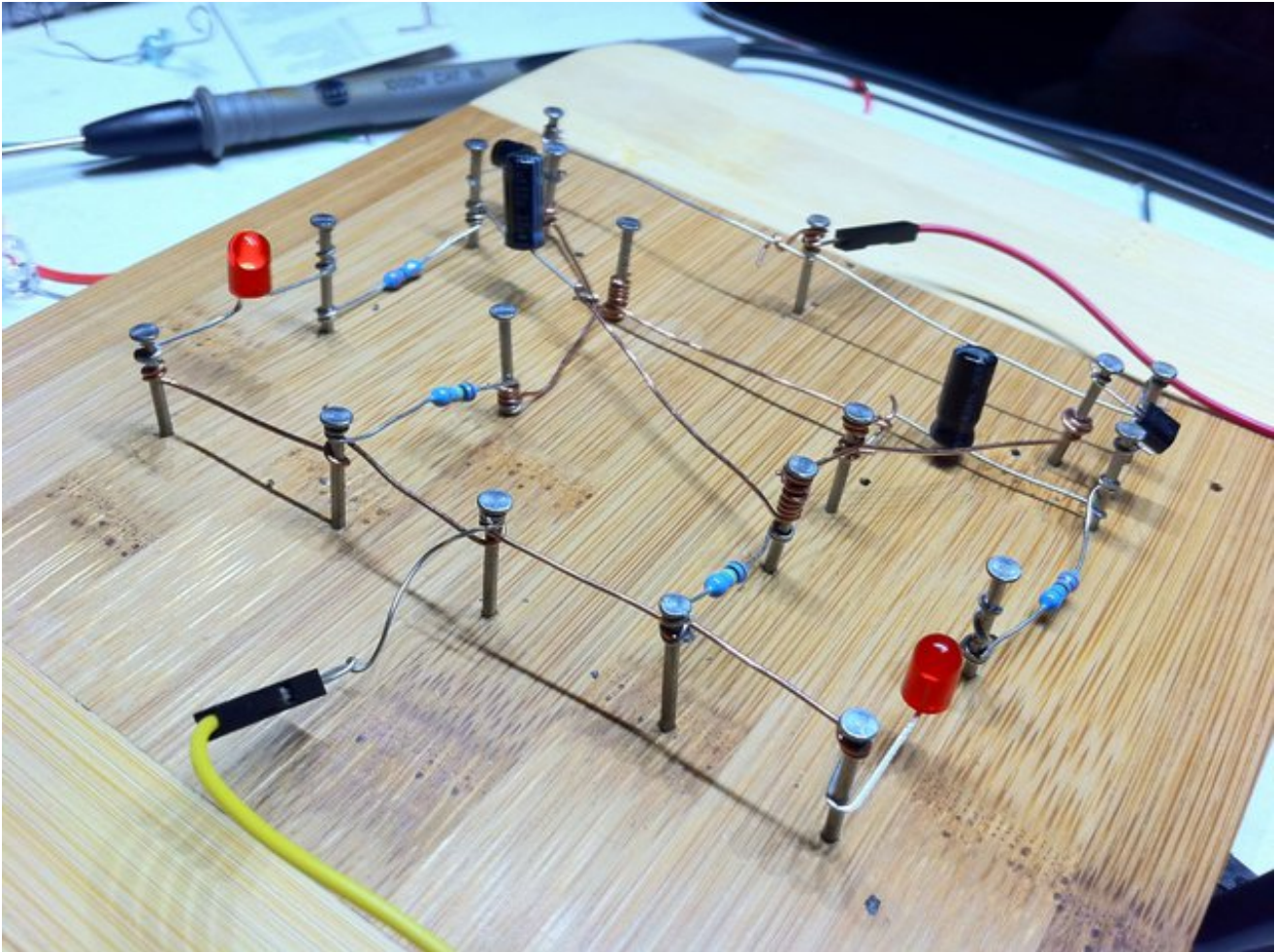

Since, back then, the components were large and the circuits were simple, it worked out OK. The large wooden board gave mechanical strength and support to project

You can even watch Collin try out this old-school technique in this video:

While these contraptions looked very cool - they were somewhat permanent and were not good for complex circuits. Also, parts got smaller and smaller so that you couldn't easily nail them down to a chunk of wood.

~~ Interlude ~~ (Wire Wrapping)

For a while in the 1960s to part of the 1980s, engineers and makers used some other techniques like [wire-wrapping](http://adafruit.com/rdd) (<http://adafruit.com/rdd>) which solved the 'complex circuits' issue but was still semi-permanent. It also required a fairly pricey wire-wrap board or the use of wire-wrap pins and sockets.

With practice, wire-wrap prototyping could be fast but took a while to get used to:

- parts were wrapped on the *opposite* side of the board so you would constantly flip back and forth
- undoing or fixing a wire wrap could be annoying if there were other wires wrapped onto the same pin
- reusing a wire-wrap board was a real pain since all the wires would have to be carefully unwrapped or cut.

Here's an example of a [wire wrap prototype with a bunch of LEDs from fastlizard4](http://adafru.it/rde) (<http://adafru.it/rde>)

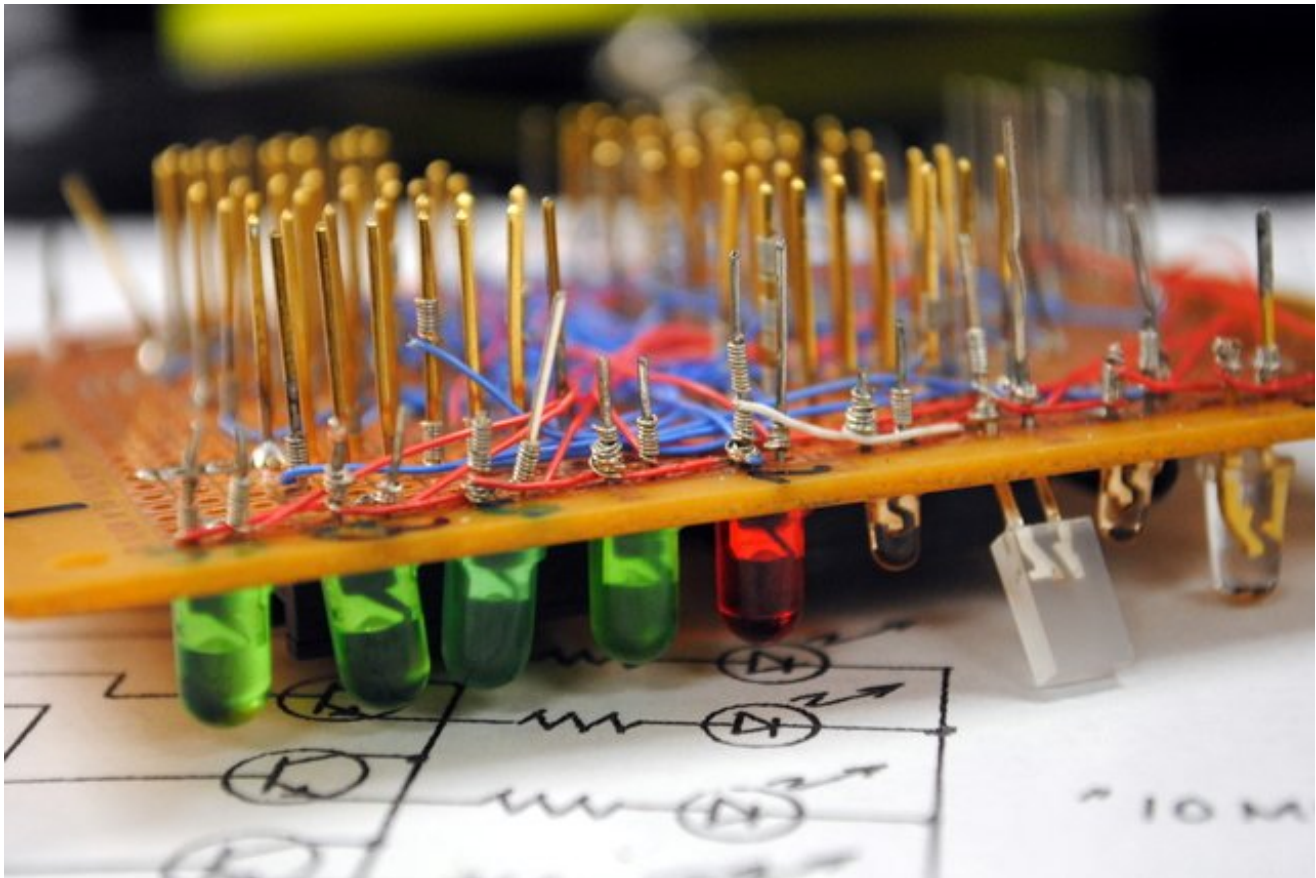

There's a little tool that helps you wrap each wire, but once solderless breadboards showed up, (and then quick-turn prototyping PCBs!) wire wrapping fell out of favor very fast.

1971 - The Breadboard Is Invented!

And then in the early 1970's an awesome thing occurred. Ronald J Portugal came up with this brilliant invention. The **BREADBOARD FOR ELECTRONIC COMPONENTS OR THE LIKE**. It was patented 2 years later and the patent expired in 1987

228,136

BREADBOARD FOR ELECTRONIC COMPONENTS
OR THE LIKE

Ronald J. Portugal, North Haven, Conn., assignor to
EI Instruments Incorporated, Derby, Conn.

Filed Dec. 1, 1971, Ser. No. 203,938

Term of patent 14 years

Int. Cl. D13-03

Des. 228,136

PAGE 2

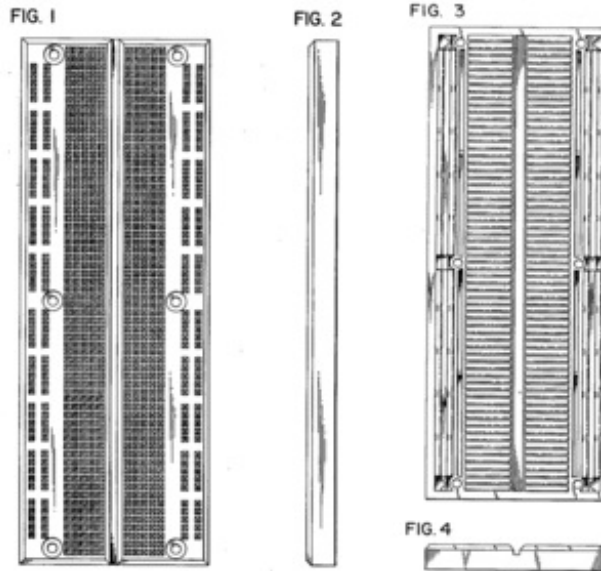

FIG. 1 is a top plan view of the breadboard for electronic components or the like.
FIG. 2 is a side elevational view.
FIG. 3 is a bottom view.
FIG. 4 is an end view.
I claim:
The ornamental design for a breadboard for electronic components or the like, as shown and described.

References Cited
UNITED STATES PATENTS
D. 221,000 4/1971 Ben, Sr. et al. D26-1 R
OTHER REFERENCES
API/AMP Terminal and Connector Handbook, 3rd ed., sub-section © 1964, p. 410, coaxial patch cord board

It was quickly called the "**Solder-less**" Breadboard because no soldering is required to use it, and then shortened to plain **Breadboard** since nobody uses a "solder-full" breadboard.

And *that's* how the breadboard got its name!

Breadboards

These "solder-less" breadboards are incredibly handy for building circuits. They are durable and reusable and have tons of work space. They not only hold your parts steady, a breadboard also has *internal wiring* to make connections super fast.

The most common type, the "Full Size" breadboard looks like this:

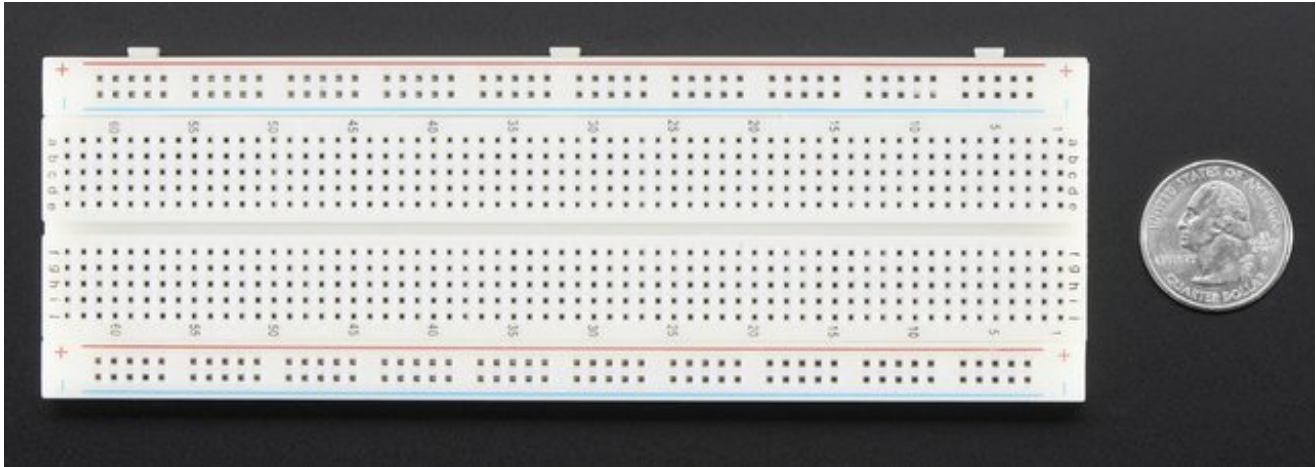

This dependable classic hasn't even changed that much [since it's invention in 1971](http://adafruit.com/rdp) (<http://adafruit.com/rdp>)!

Basically, a chunk of plastic with a bunch of holes. However, something special is going on inside the breadboard! Although you can't see it, inside the breadboard are many strips of metal that connect the rows and columns together.

If you look on the back of your breadboard, there's a yellow waxy paper covering some sticky foam. If you were to peel back that foam you'd see dozens of these metal rows.

(Don't actually do this, you should keep the yellow paper on your breadboard, we'll sacrifice this one for some photos!)

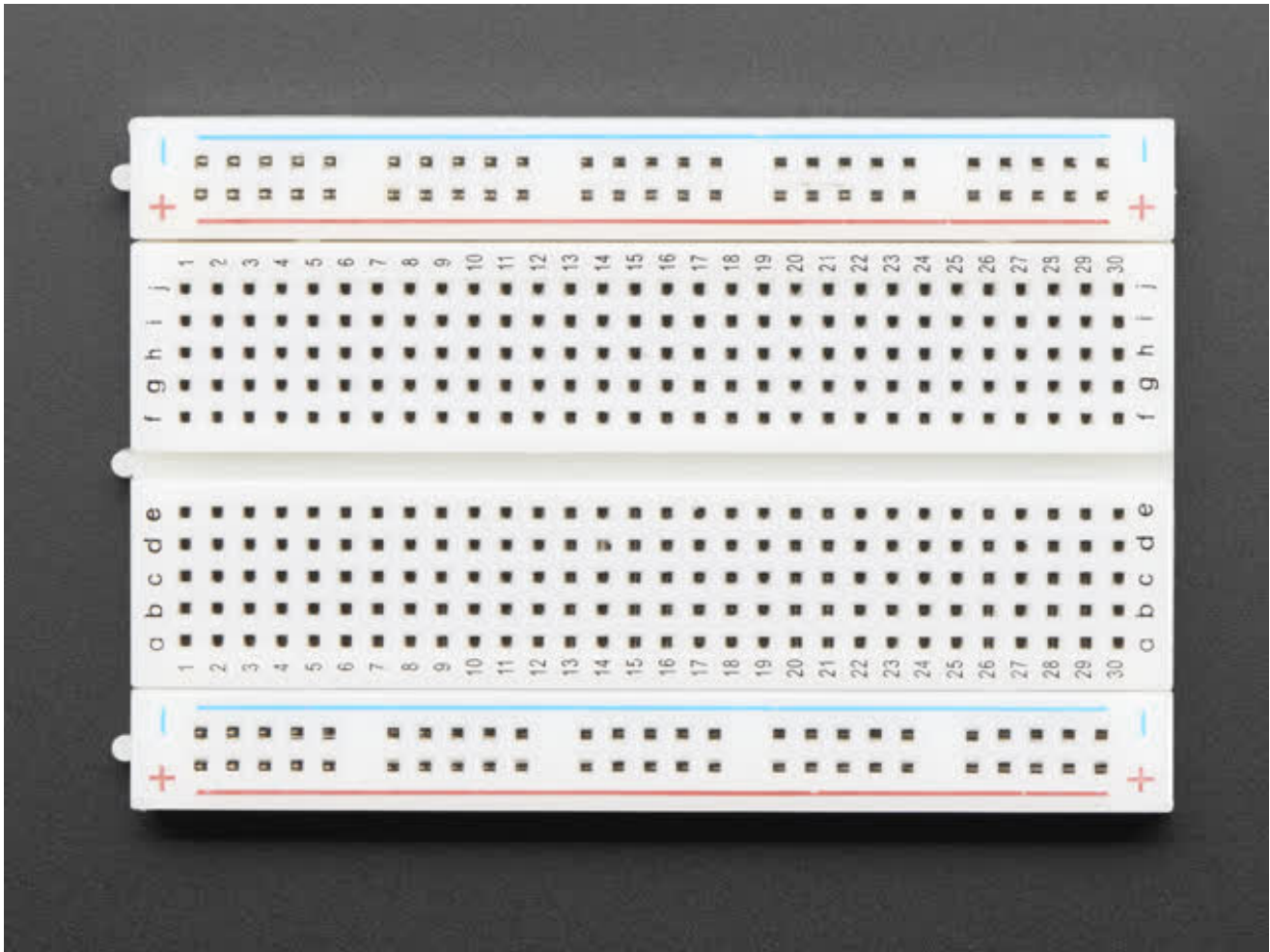

If you pulled the metal parts out with pliers (again, don't do this yourself!) You'd see each one is a metal clip with little teeth. The rows have 5 teeth - one for each hole on the top of the breadboard. (The power rails have 50 teeth)



These little teeth are great at gripping onto electronic parts. When a part is pushed into the breadboard, the clip pushes open and grabs onto the metal leg. Any other parts that are plugged into the other 4 teeth are thus electrically connected together

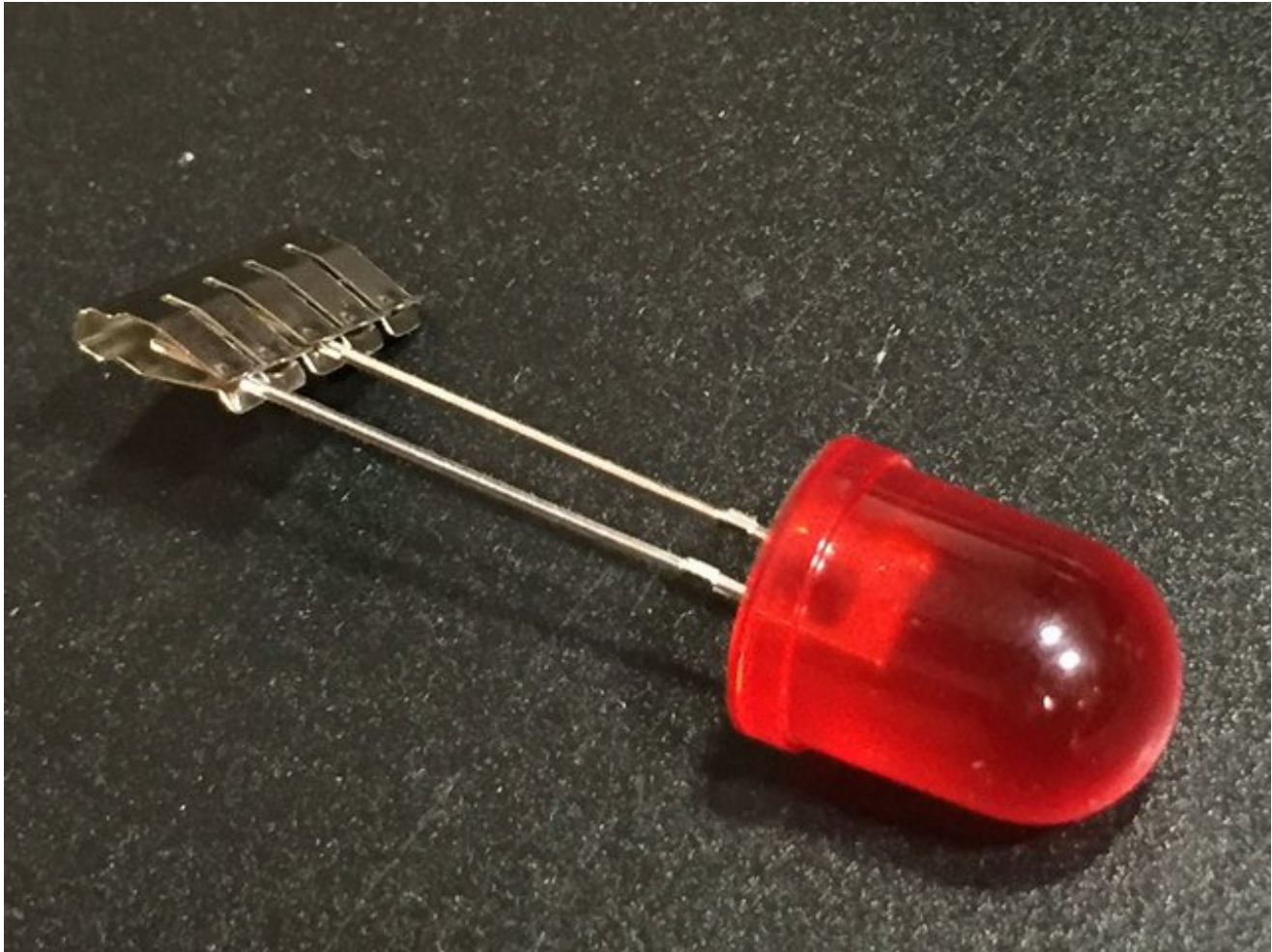

Just about every breadboard is made of three sections: Two sets of very long power rails and the large middle section that is full of those 5-hole-long terminal strips.

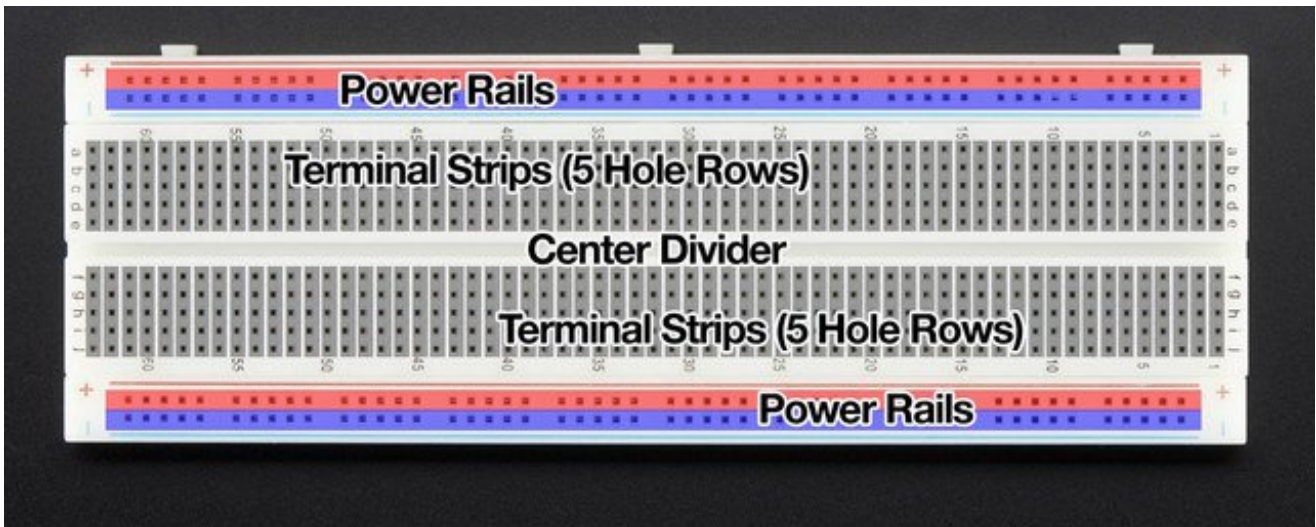

You put the components (buttons, LEDs, resistors, integrated circuits, etc) in the middle section, with each pin connected to the rows terminal strip. The power rails are long

columns used to distribute the power and ground connections along the entire circuit.

As you build circuits you'll quickly find that each part usually needs a connection to power or ground, so having a *lot* of power/ground pins available will be very handy. To help you keep track of which rail is ground and which is power, there's a red (+) and blue (-) stripe down the sides of the rails. Just make super-sure you connect positive to (+) and ground to (-) or you're gonna have a bad time!

The curse of the flaky breadboard

Distressing as it may sound, solderless breadboards can be flaky, especially as they age. If you're having problems with your circuit, it could be that the little metal clips on the inside aren't working well. Try poking it with your finger, or moving it to a different section.

Each clip can handle at least a hundred plugs and unplugs before the springiness of the clip slowly weakens and eventually stops gripping so well. You'll know when the breadboard needs replacing because you won't feel the clip gripping onto the part when you press it in.

However, this takes *years* to happen. Even if you did have to replace it, breadboards are quite affordable. Most makers have a half dozen different sizes for projects, sometimes dedicating each one to a 'long term' project and keeping one for playing around.

Other Breadboard Sizes

Half Size

The full size breadboard is good for larger projects but I rather prefer the *half size* breadboard. These are (surprise!) about half the length of the full size breadboard. It has 30 rows and 400 total connection points

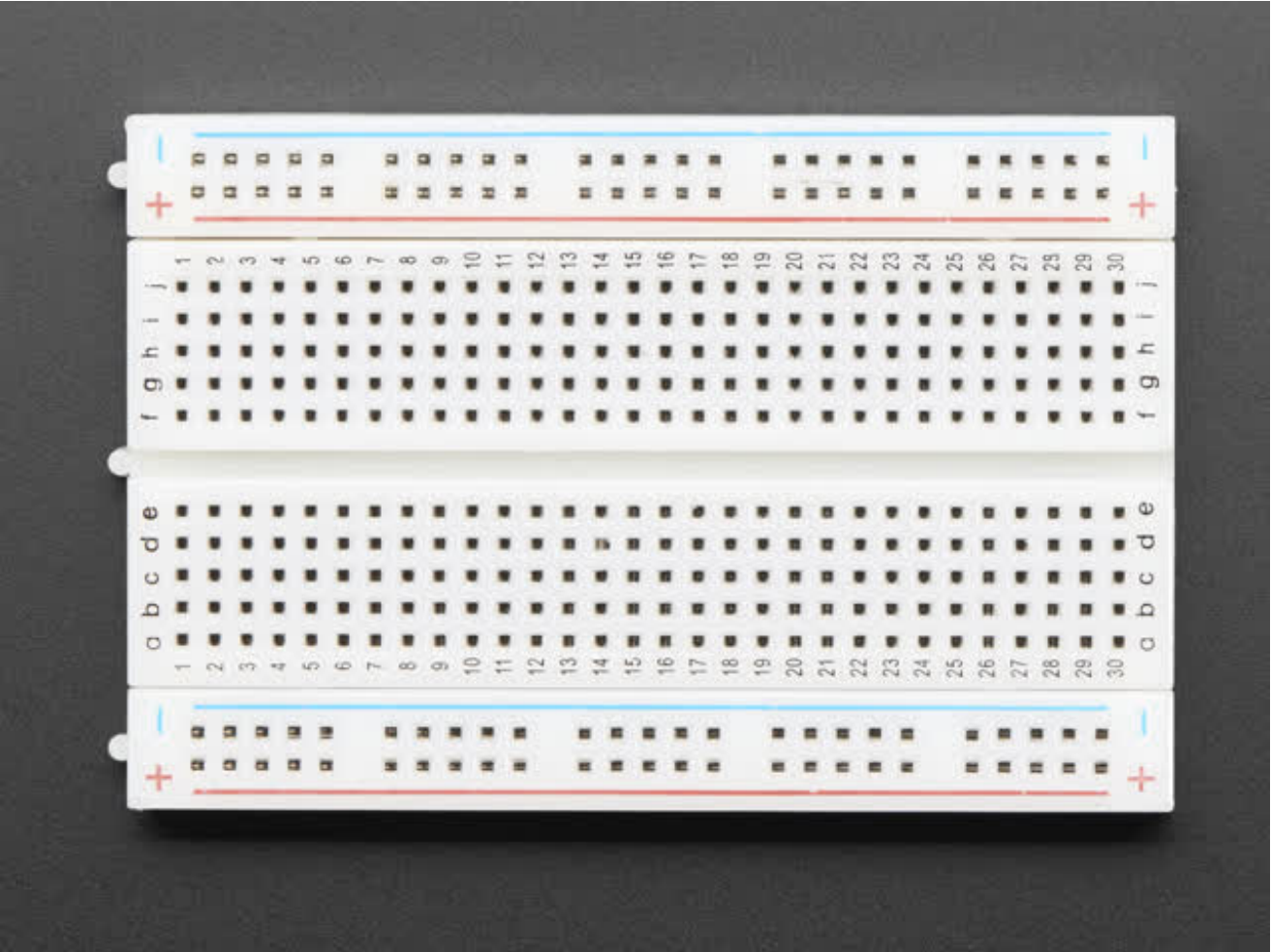

They're great for small projects, you can usually fit a small Arduino-compatible and some sensors and LEDs.

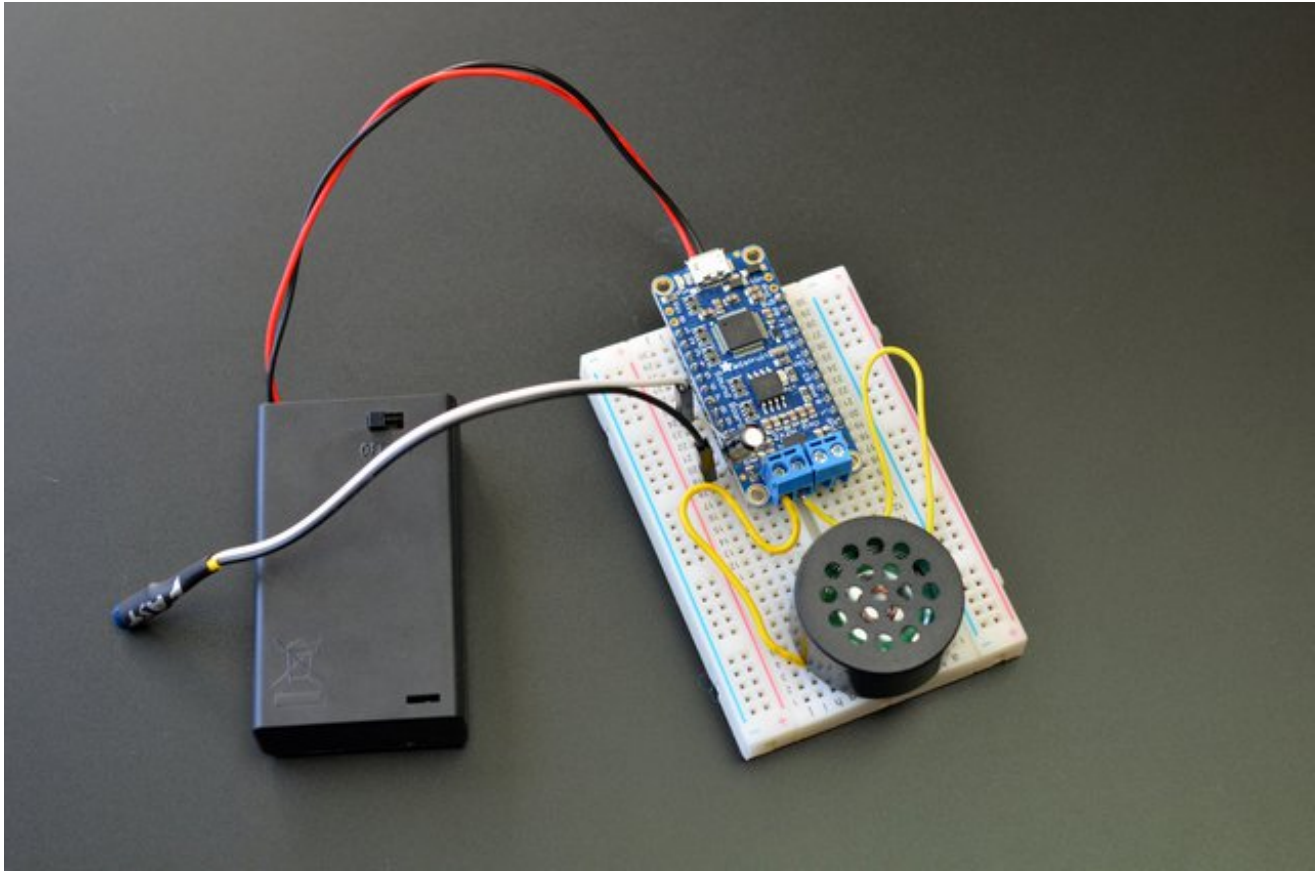

Tiny Breadboard

Sometimes you want to *get small*- if even the half-sized breadboard is too big for your needs check out the tiny breadboard.

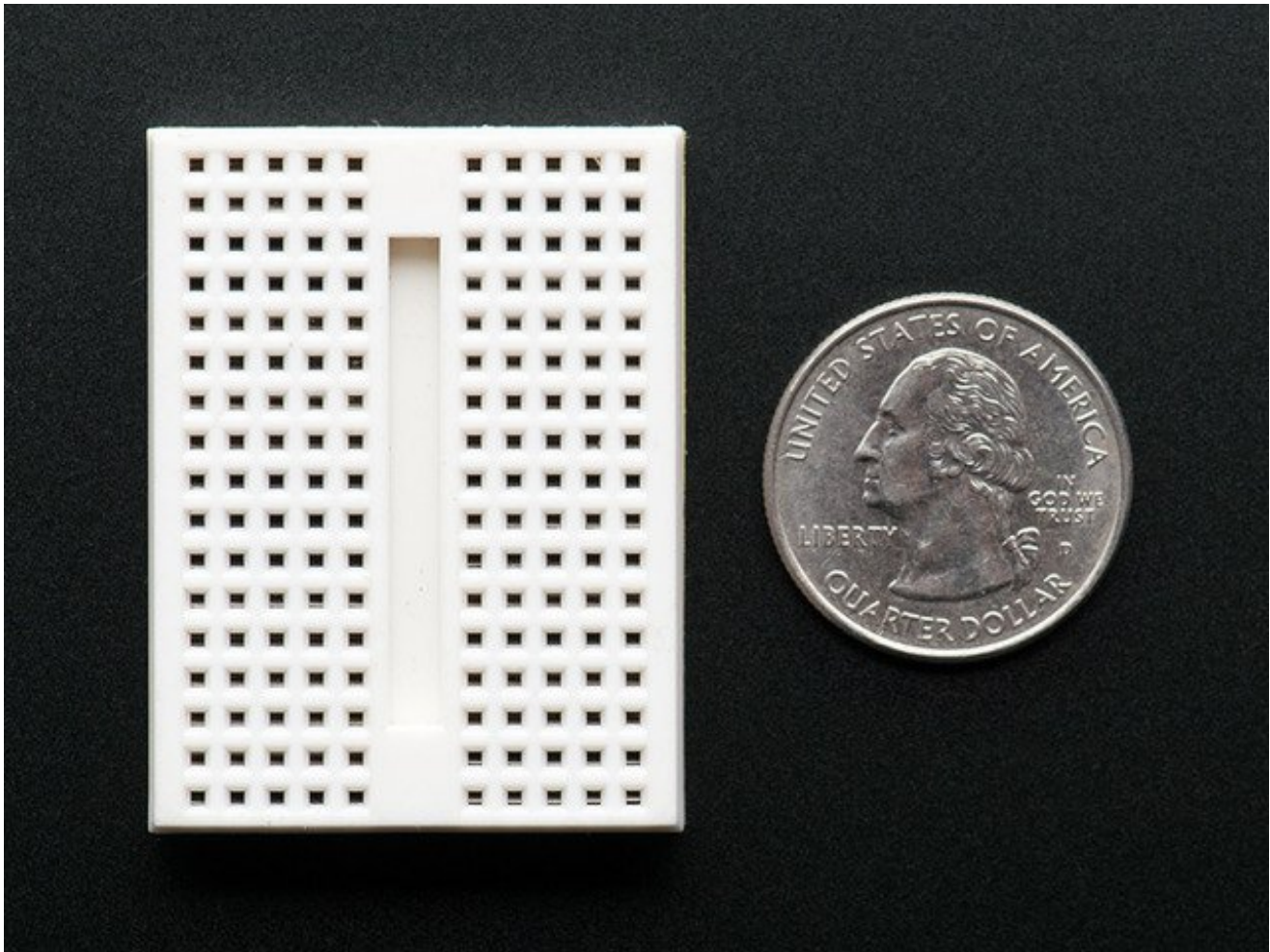

Note that this breadboard **does not have power rails!** But it is really cute, with only 17 rows (170 total connection points) which makes up for it. Good for when you only have a few components to wire up like this [little audio visualizer by Bill Earl](http://adafru.it/rdr) (<http://adafru.it/rdr>)

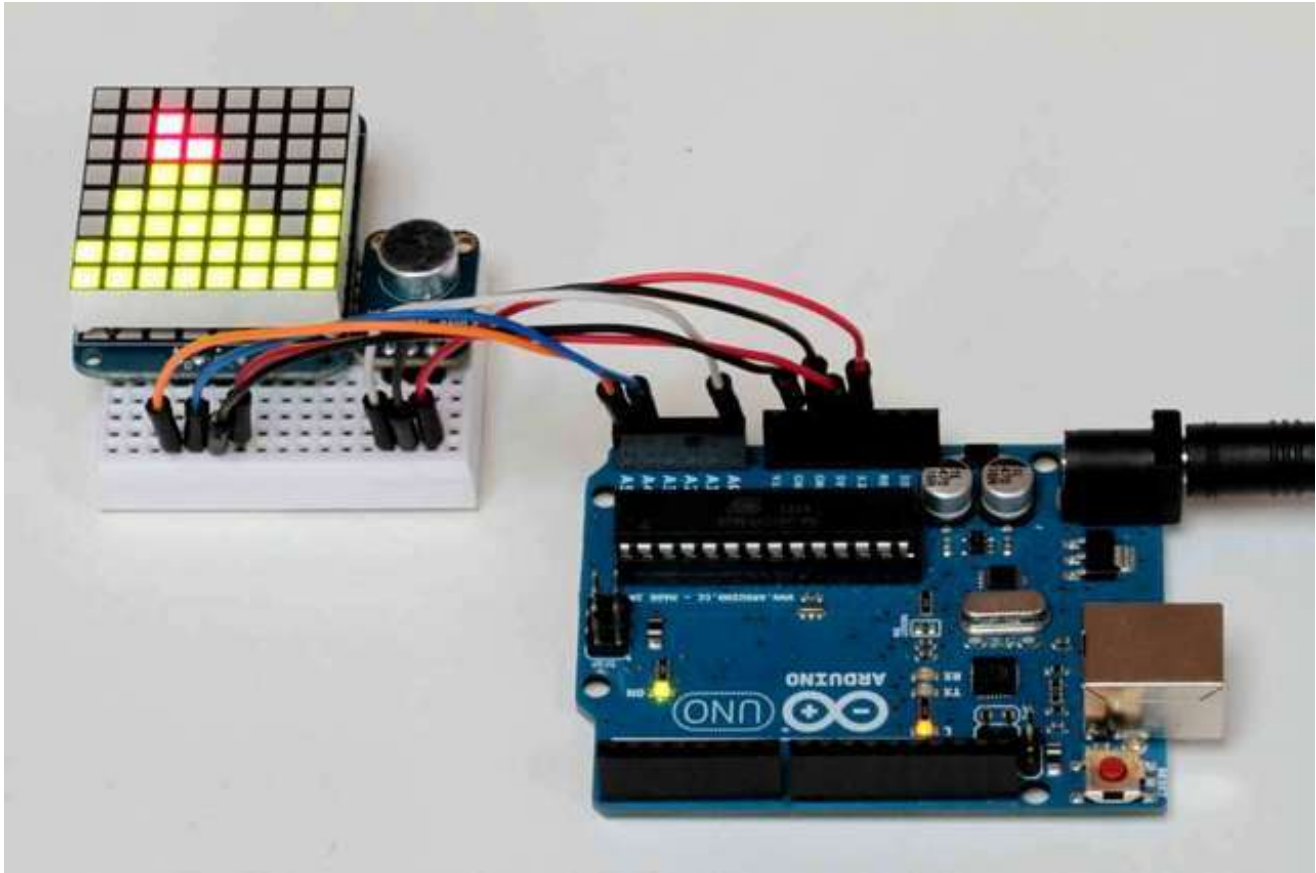

Little Breadboard Bits

I don't even know the proper names of these but they're basically little 'crumbs' of a breadboard, for the simplest configurations

The terminal strips on these babies come out to tabs, we've found you can solder these to a perfboard or wire which might make them useful for adding small breadboarding sections to a perfboard or perma-proto

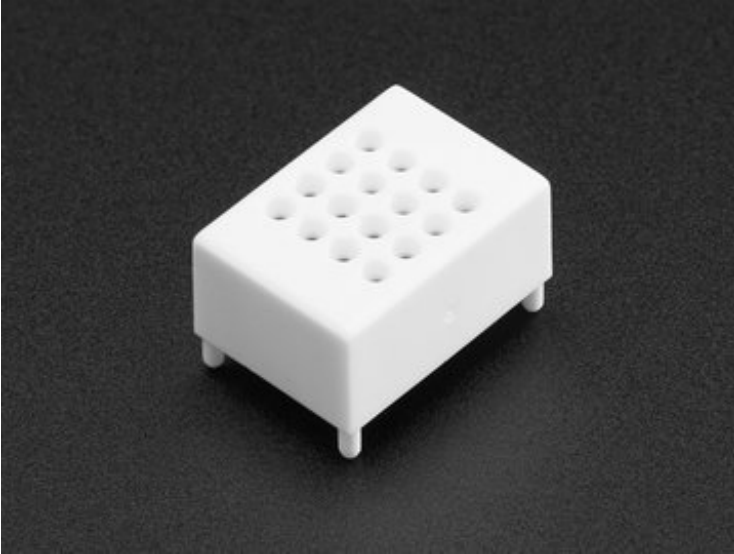

[The 4x4 mini breadboard has four strips of 4-pin terminal strips \(http://adafru.it/2463\)](http://adafru.it/2463)

•



•

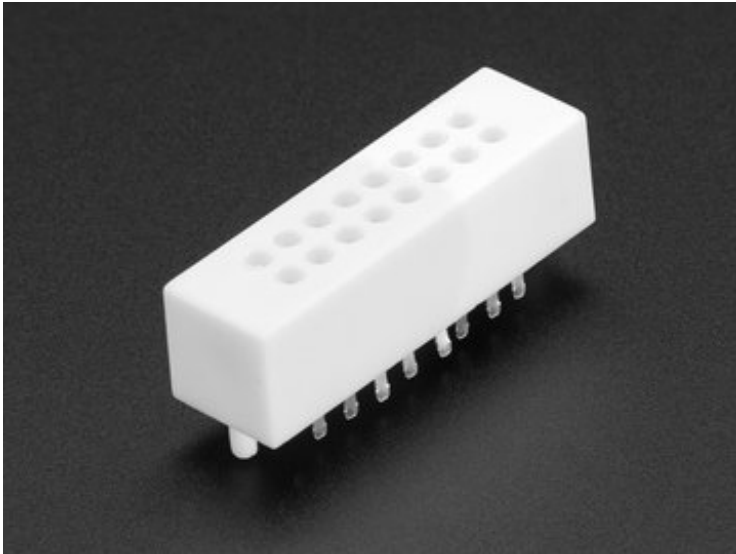

[The 2x8 mini breadboard has 8 strips of 2-pin terminal strips \(http://adafru.it/2018\)](http://adafru.it/2018)



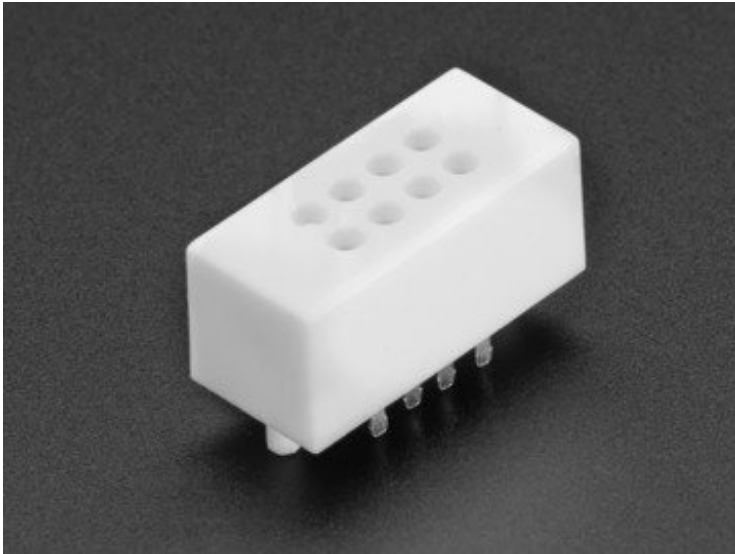

[The 2x4 mini breadboard has four strips of 2-pin terminal strips \(http://adafru.it/2017\)](http://adafru.it/2017)

•

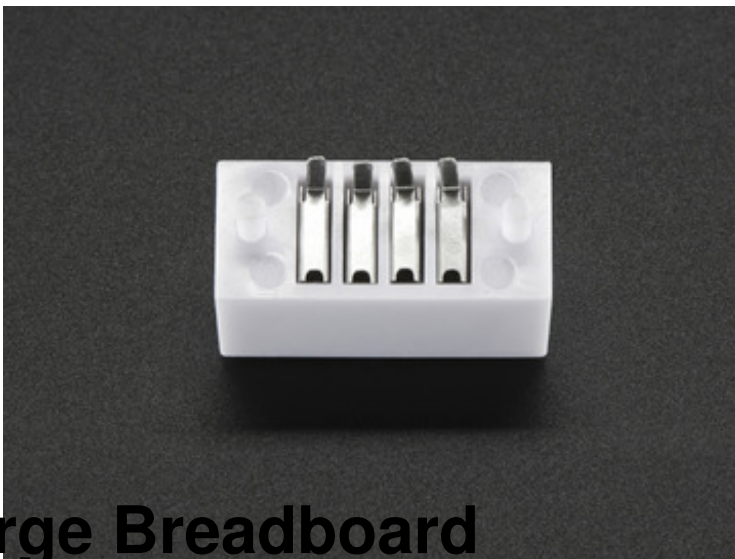

Large Breadboard



For really big projects, give yourself some room to work in, with a massive 2250-point breadboard - equivalent in size to three full sized breadboards side by side.

The breadboards are mounted onto a metal plate, and comes with 4 colored posts you can use with a bench-top supply. Four bumpers are included, to keep the board from slipping around your desk.

Like nearly all large breadboards, the 'power rails' are split in the middle! That means that if you want to plug in a voltage at the top of the board, it won't appear at the bottom. Since this often trips people up, we strongly suggest drawing lines onto the breadboard the moment you get it! [Just follow this image to see where the splits occur. \(http://adafru.it/rds\)](http://adafru.it/rds) Each drawn red line is a split.

Breadboard Usage

Lets say you want to do a very simple circuit, you just want to light up an LED using a battery pack. It's a simple hookup with only 3 parts. Here's the schematic:

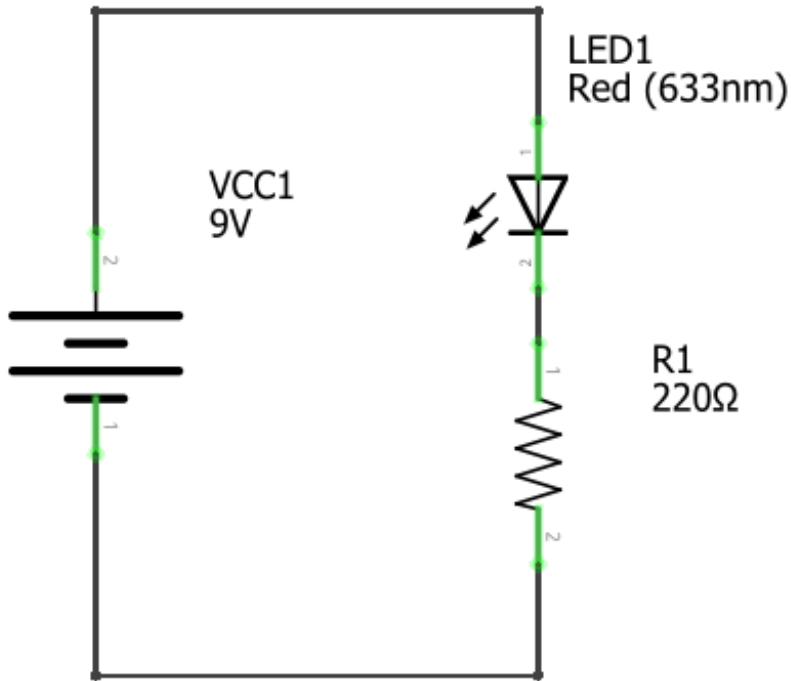

- Connect the battery positive (red) wire to the positive (longer) leg of the LED
- Connect the shorter leg of the LED to one side of the resistor
- Connect the other side of the resistor to the battery negative (black) wire.

Despite having only three connections, wiring this up with alligator clips makes for a large and unwieldy tangle of wires

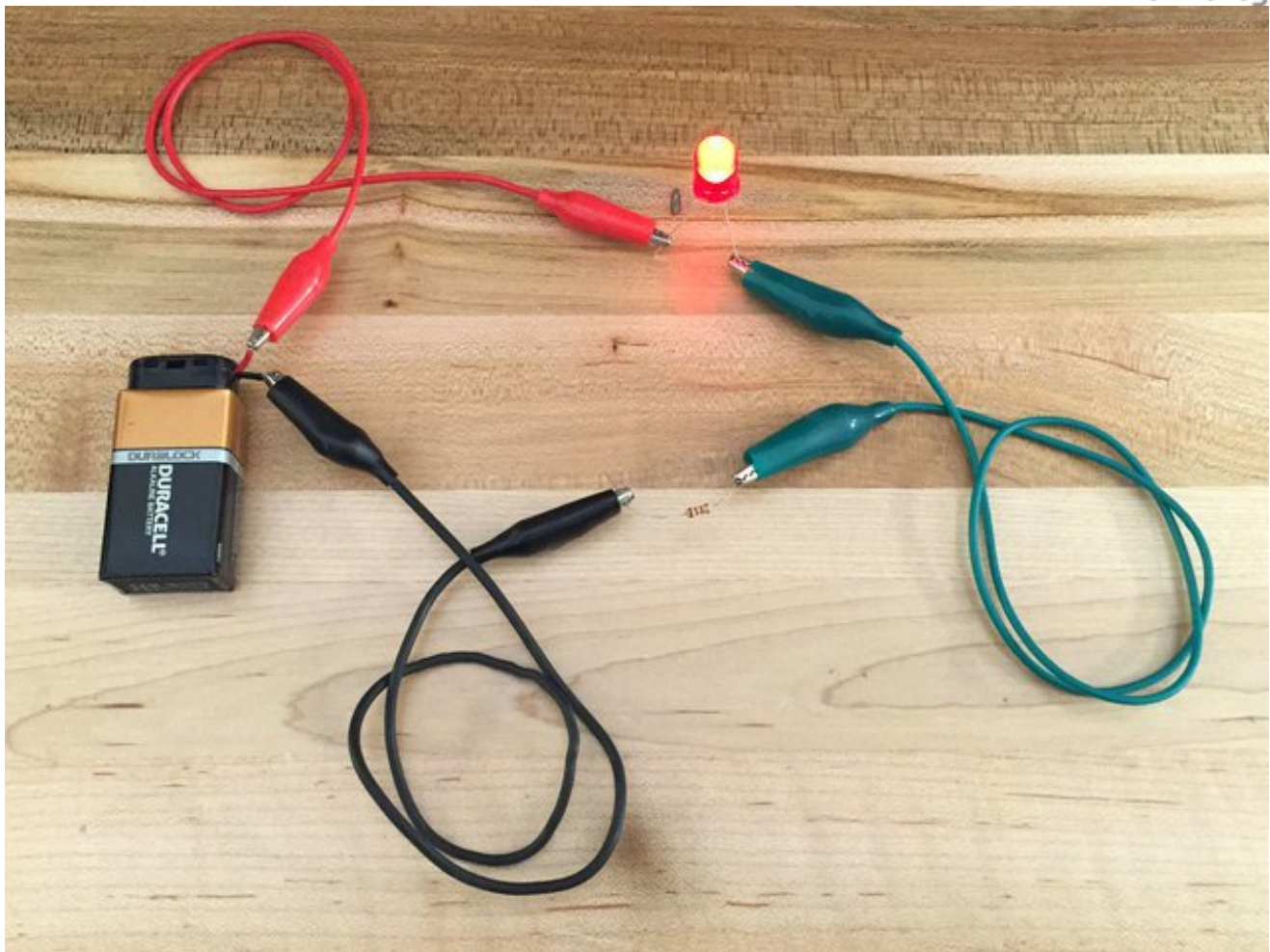
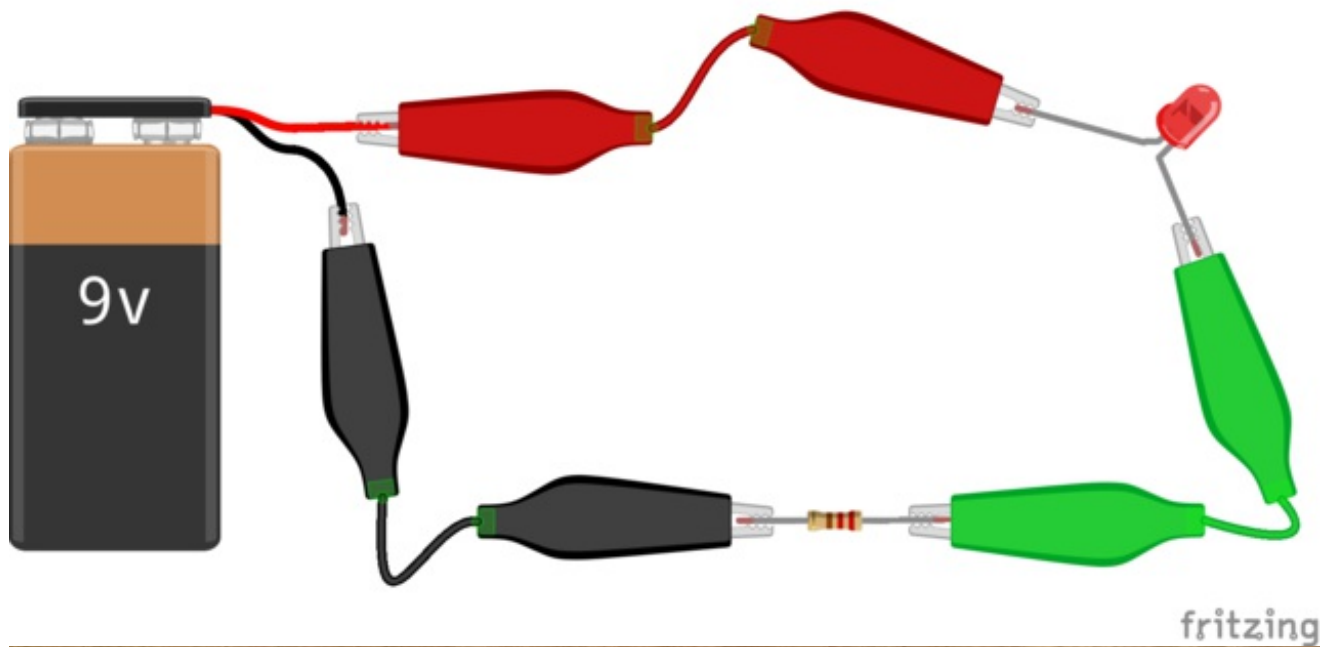

Compare to how neat and organized it is with a breadboard! No long wires, and its easy to swap in a different resistor or LED when you feel like it

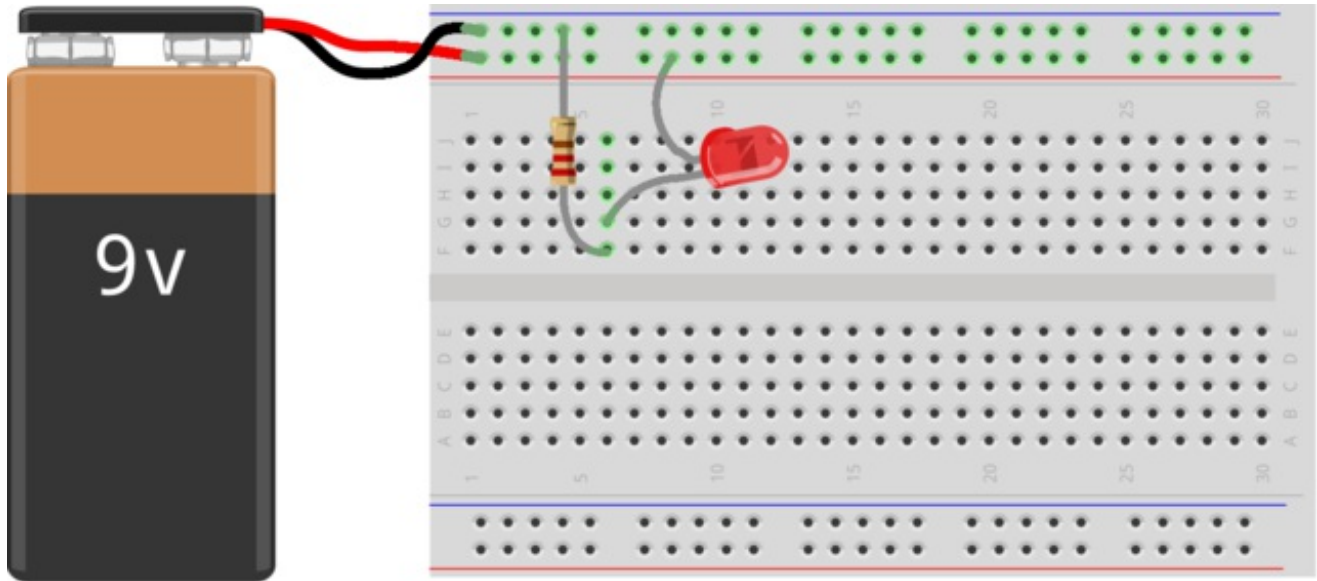

fritzing

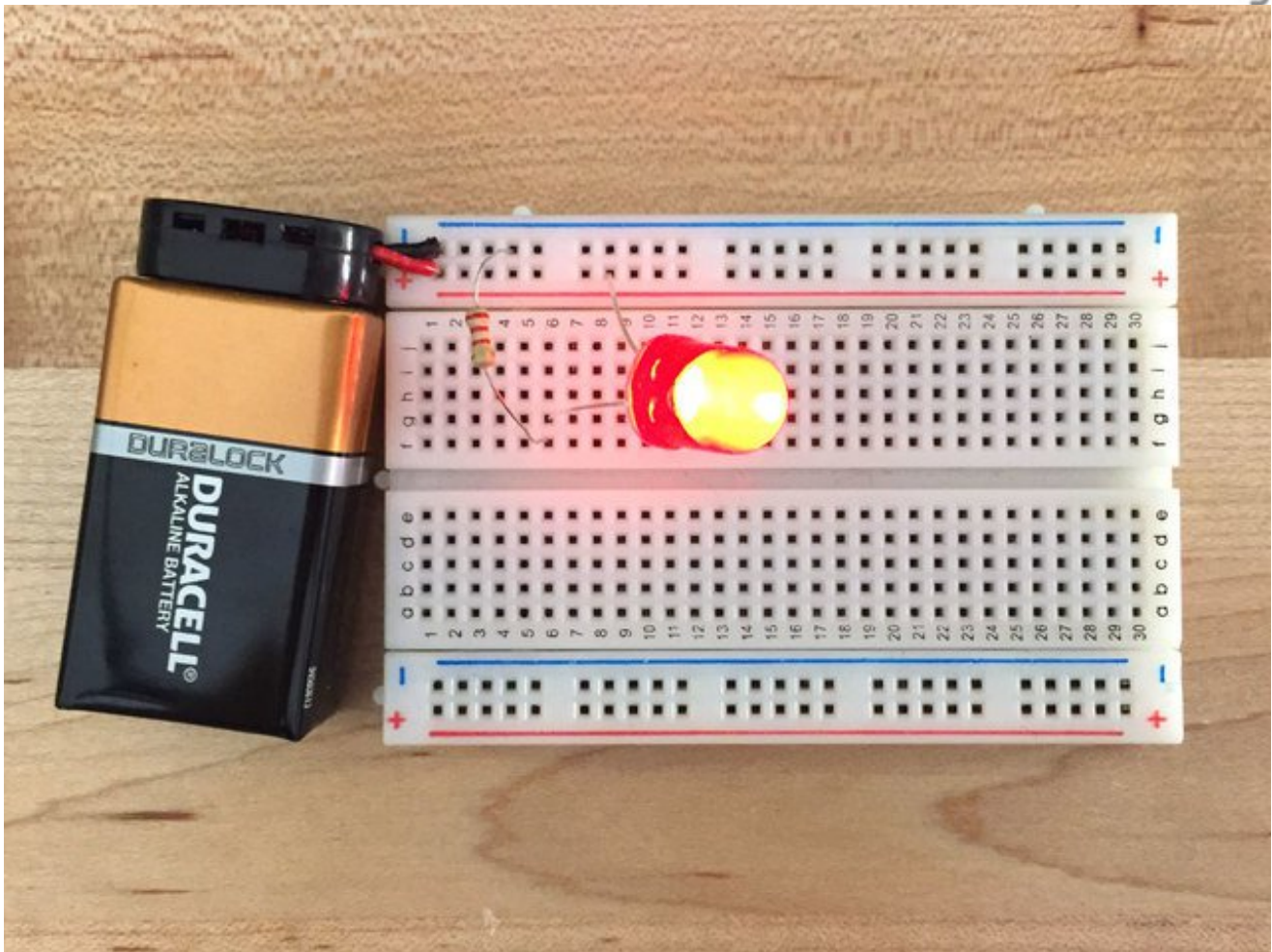

Adding DIPs and Modules

Wiring up a single LED is no problem, so let's continue and add more complex components. Parts like DIP (dual in-line pin) chips are a perfect match.

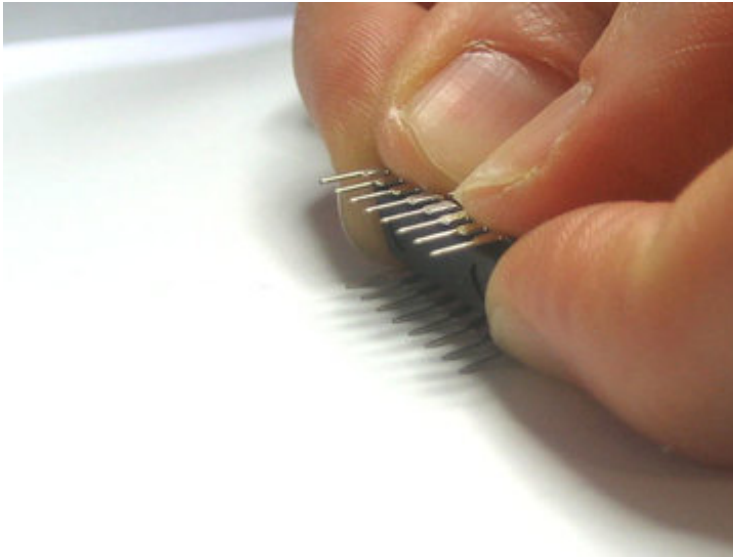

When new, the pins are not quite straight, they're bent out a little like an /--\ shape. You can carefully press the pins against a tabletop, and rock them forward together to bend into a |--| shape

•

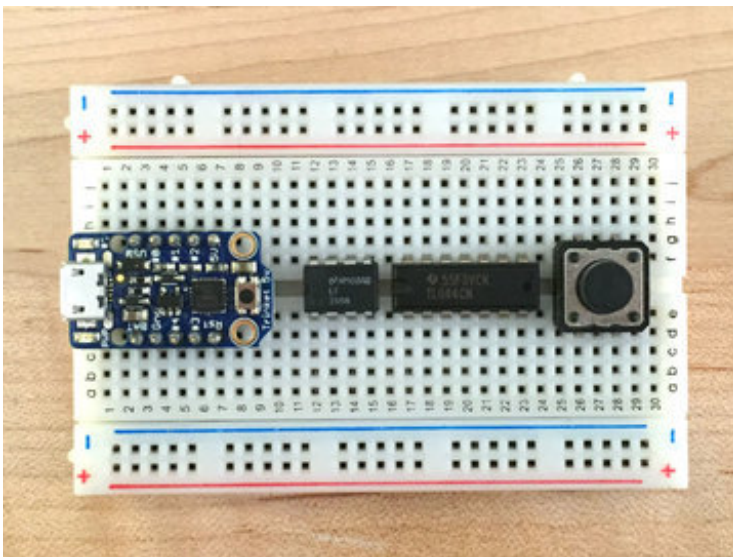

Then carefully press into the center of the breadboard. Watch out for bent pins!

•

You can remove the chips easily by slipping a thin screwdriver or

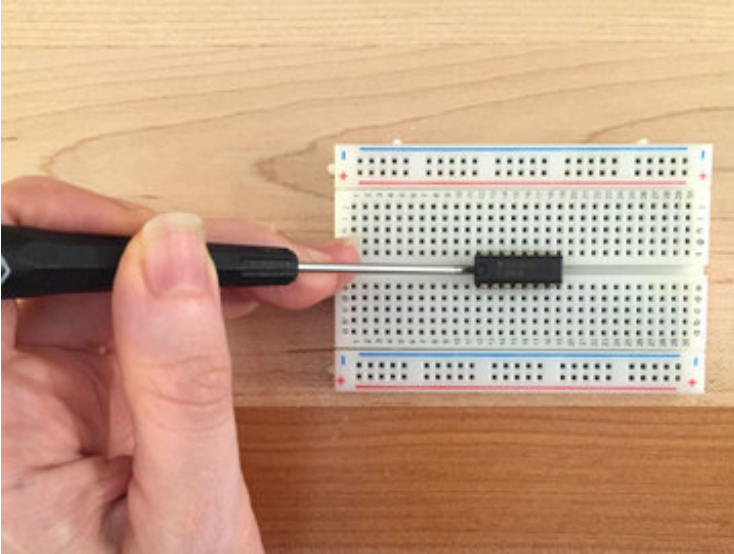

awl down the center ravine/divider and *carefully* prying upwards.

Pry from both sides if possible to keep the pins from bending by accident.

•

Jumper Wires

There are lots of little connections inside of your breadboard but they only go along in rows, basically making each pin or wire of a part have 5 total connection points. To wire up the parts you'll need to, um, *wire* the parts...with **wire**!

DIY Solid Core Wire Jumpers

With not too much effort you can craft your very own *artisanal* wires!

You'll need a pair of wire strippers, ideally the kind with a bunch of different hole sizes



Multi-size wire stripper & cutter

PRODUCT ID: 147

We've upgraded our basic 'adjustable' wire strippers to these multi-sized wire strippers. They include: 20-30 AWG strippers, wire cutters, 'plier' tips, and a wire...

<http://adafru.it/rf1>

\$6.95

IN STOCK

And of course, some wire!



Hook-up Wire Spool Set - 22AWG Solid Core - 6 x 25 ft

PRODUCT ID: 1311

Perfect for bread-boarding, free wiring, etc. This box contains 6 spools of solid-core wire. The wire is easy to solder to and when bent it keeps its shape pretty well. We like to have a...

<http://adafru.it/dya>

\$15.95

IN STOCK

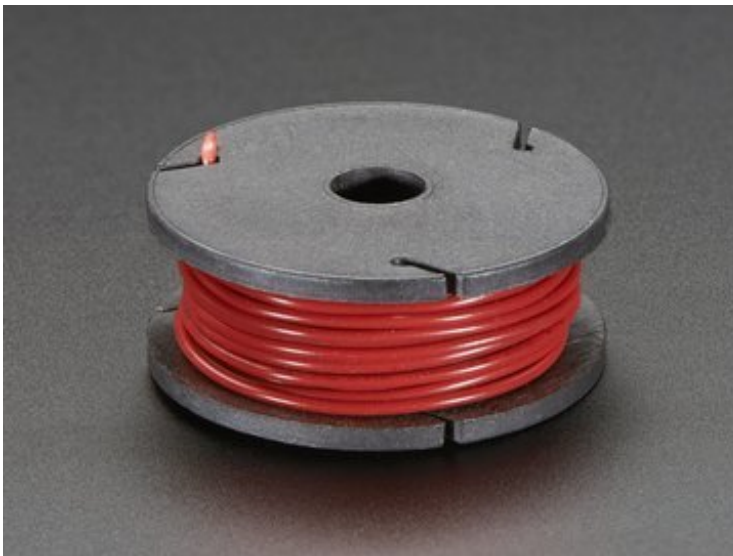

Most important thing to remember is you must use solid-core wire, ideally 22 American Wire Gauge (AWG).

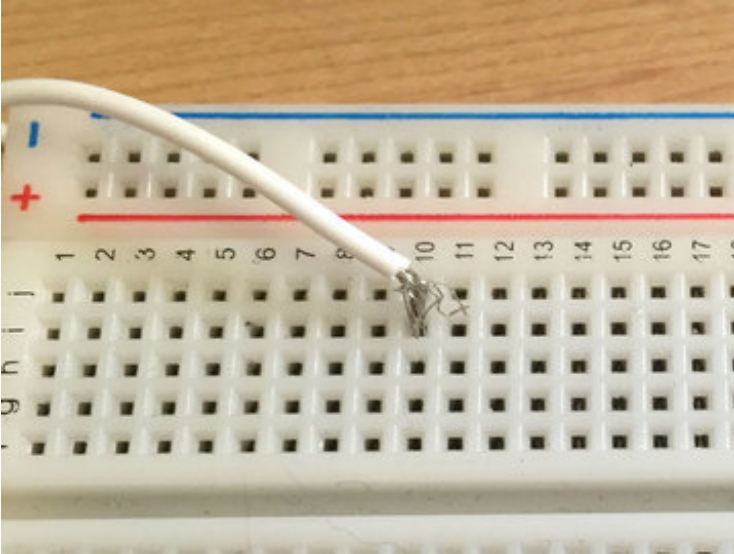

You can't use stranded core easily because the threads/strands of the wire will unravel, shorting with nearby parts by accident

•



[Start with a spool of 22 AWG solid core wire \(http://adafruit.it/rf2\)](http://adafruit.it/rf2)

•



Pick the matching hole/slot for the wire you're stripping, and remove about 1/2 to 1 cm of the plastic covering off the end

Make sure you don't nick or cut the wire, because that could weaken it.





Cut the other side to length, remember you'll need a little extra so that you can strip the other end too!



Strip 1/2 to 1 cm off the other end like before

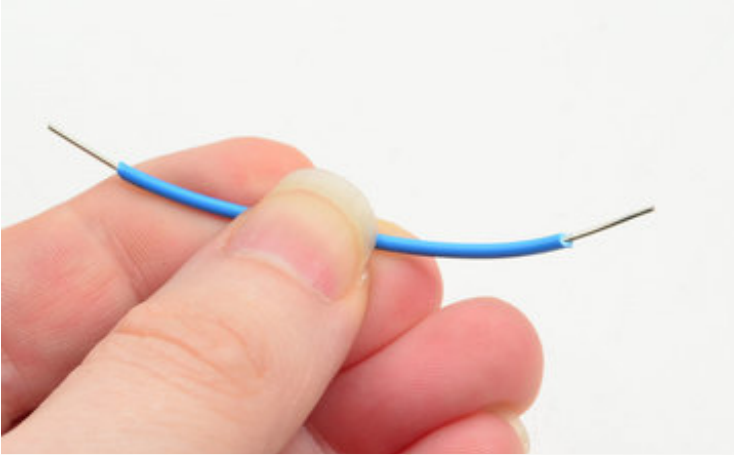

Voila! A single jumper wire

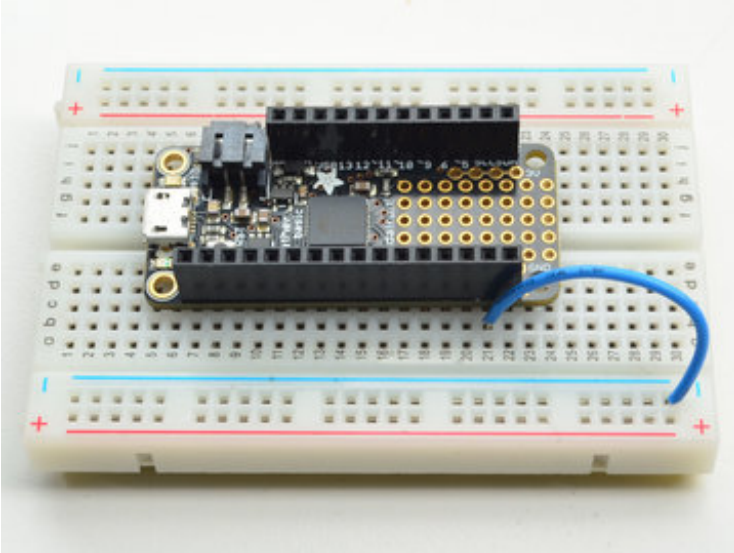

Plug in both ends into the breadboard as desired to make an electrical connection



Pre-made Jumper Wires

There's nothing wrong with DIY jumpers, and for the *neatest* looking breadboards, you'll want to use them.

That said, sometimes you just want to be wiring ASAP. That's where pre-made jumper wires are really great. They're a little more expensive but you don't need wire strippers and they have these lovely grips.

[We have these in a wide variety of lengths and configurations](http://adafru.it/rf3) (<http://adafru.it/rf3>) Usually, we like to start our breadboard wiring with these and then 'clean up' with hand-cut ones once we know the wiring is correct and the lengths won't change



Premium Male/Male Jumper Wires - 40 x 3" (75mm)

PRODUCT ID: 759

Handy for making wire harnesses or jumpering between headers on PCB's. These premium jumper wires are 3" (75mm) long and come in a 'strip' of 40 (4 pieces of each of ten rainbow colors)....

<http://adafru.it/rf4>

\$3.95

IN STOCK

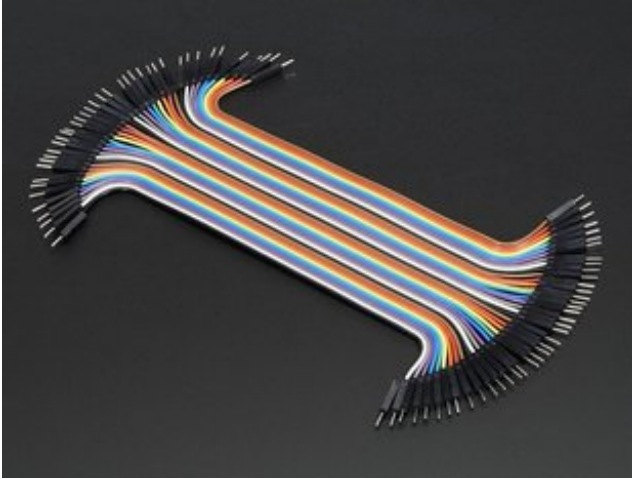

Premium Male/Male Jumper Wires - 40 x 6" (150mm)

PRODUCT ID: 758

Handy for making wire harnesses or jumpering between headers on PCB's. These premium jumper wires are 6" (150mm) long and come in a 'strip' of 40 (4 pieces of each of ten rainbow colors)....

<http://adafruit.it/rf5>

\$3.95

IN STOCK

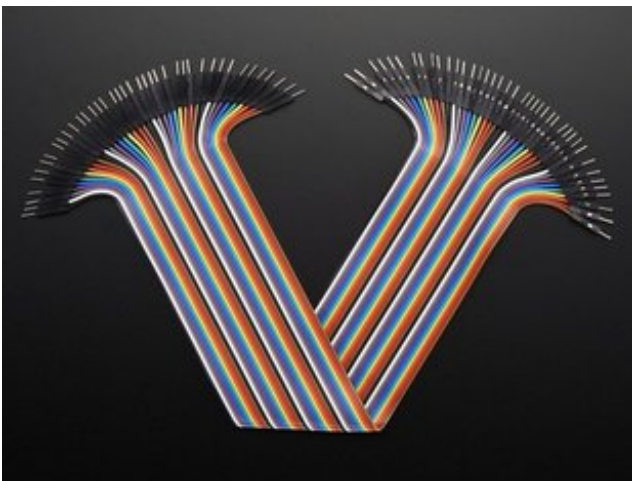

Premium Male/Male Jumper Wires - 40 x 12" (300mm)

PRODUCT ID: 760

Handy for making wire harnesses or jumpering between headers on PCB's. These premium jumper wires are 12" (300mm) long and come in a 'strip' of 40 (4 pieces of each of ten rainbow...)

<http://adafruit.it/rf6>

\$7.95

IN STOCK



Perma Protos

OK so you've prototyped your brilliant invention on a breadboard. But you're no slacker - you're ready for your next project! You have a few choices: Let projects 'live' on their breadboard. When done, just buy a new breadboard and start fresh. *Or* you could remove all the components and recycle both the parts and breadboard.

- *Or* there's another option where you transfer the circuitry from the breadboard to a permanent circuit board like an [Arduino Proto Shield for example \(http://adafru.it/2077\)](http://adafru.it/2077).
- *Or* you may love your project that you realize that breadboards can slowly rust, and parts can come loose
- *Or* you may want to put your project in a nice box, so you need something that is more durable

For any of these reasons you may want to use a **Perma-Proto** board. These are basically the non-solderless version of breadboards (solder-full?). You get a sturdy printed circuitboard with nearly-identical layout (the rails are closer and there's more holes)

For example, here's the half sized perma proto front, back and next to a half sized breadboard

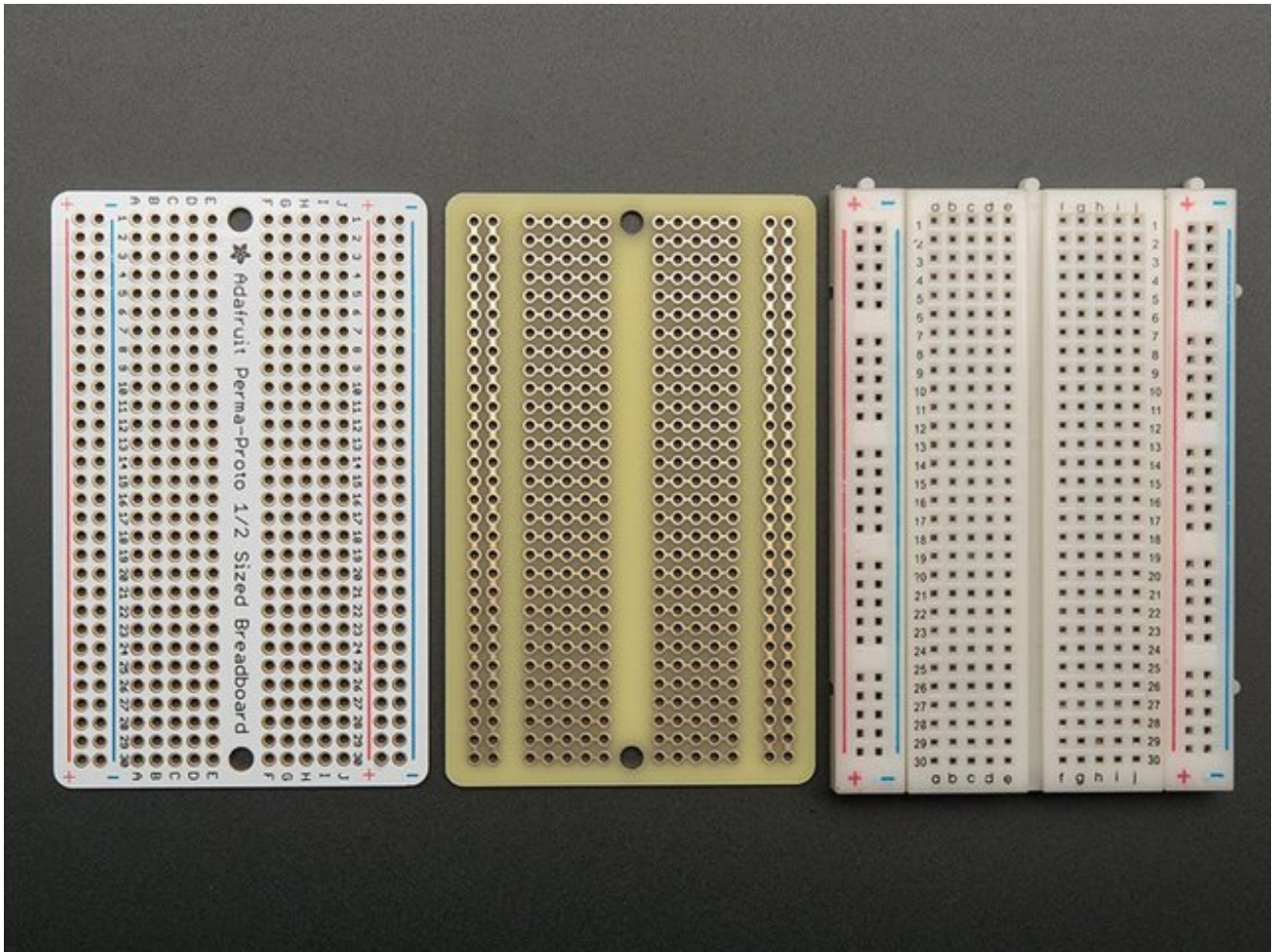

We basically just took the basic layout of a half-sized breadboard and turned that into a beautiful PCB. The top side has a white silkscreen, and the same markings you're familiar with, to make transferring components easy. The bottom has the 5-hole pad design that matches a classic breadboard, with 4 power bus lines on the sides, and no mask so you can easily cut traces when necessary.

We used 1.2mm diameter drill holes so even parts with big leads will fit. All holes are thru-plated for strength and the finish is a gold plate - you won't get oxidation like with bare copper perf board!

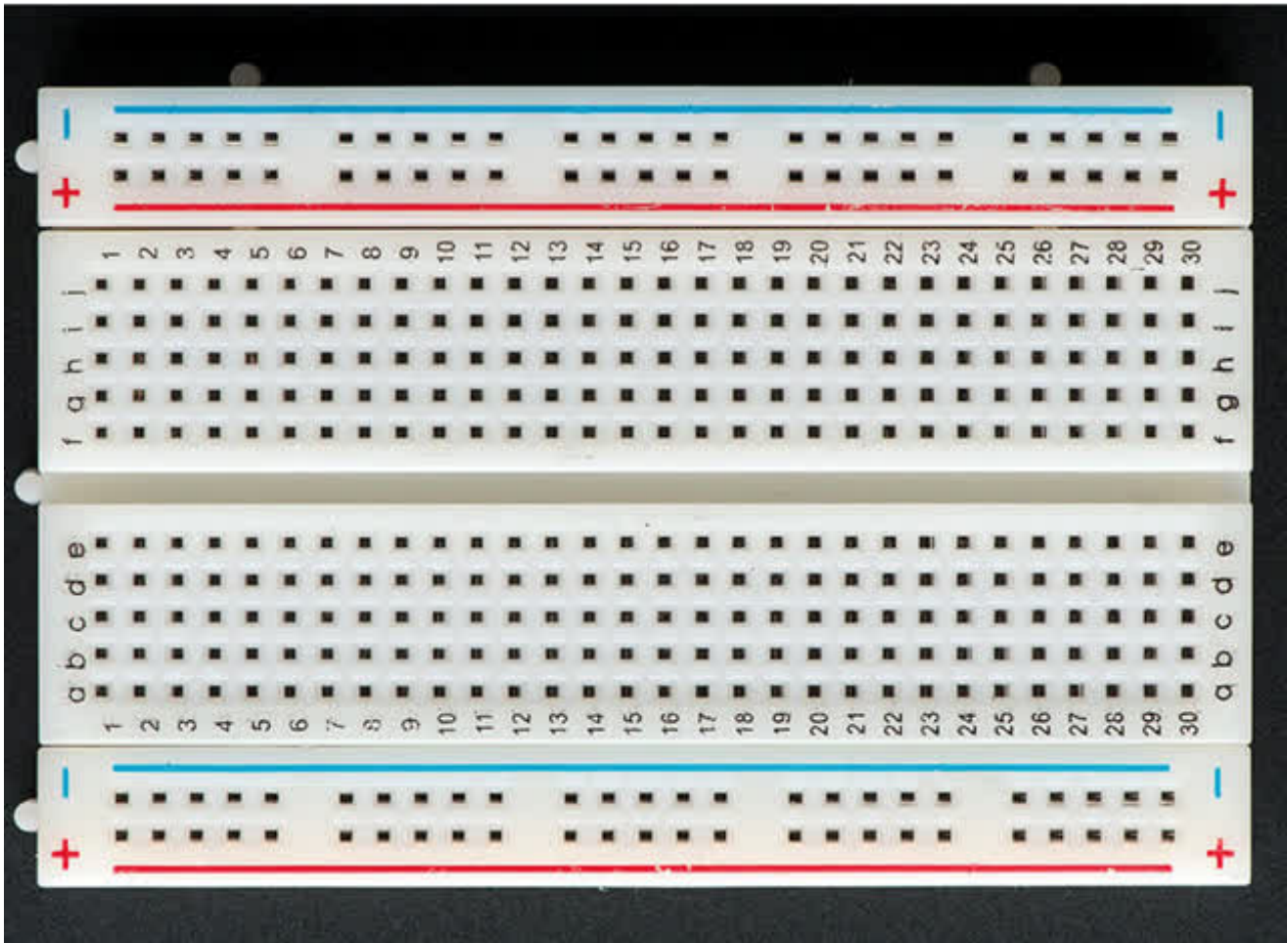

There are also two mounting holes so you can attach the PCB to your project box. They'll also fit nicely in [an Altoids-sized mint tin](http://adafru.it/97) (<http://adafru.it/97>)

For example, [here is Mike Barela's pro trinket project](http://adafru.it/rd5) (<http://adafru.it/rd5>) on a breadboard and then a finished version that is soldered onto a perma-proto and attached to an old mint-tin

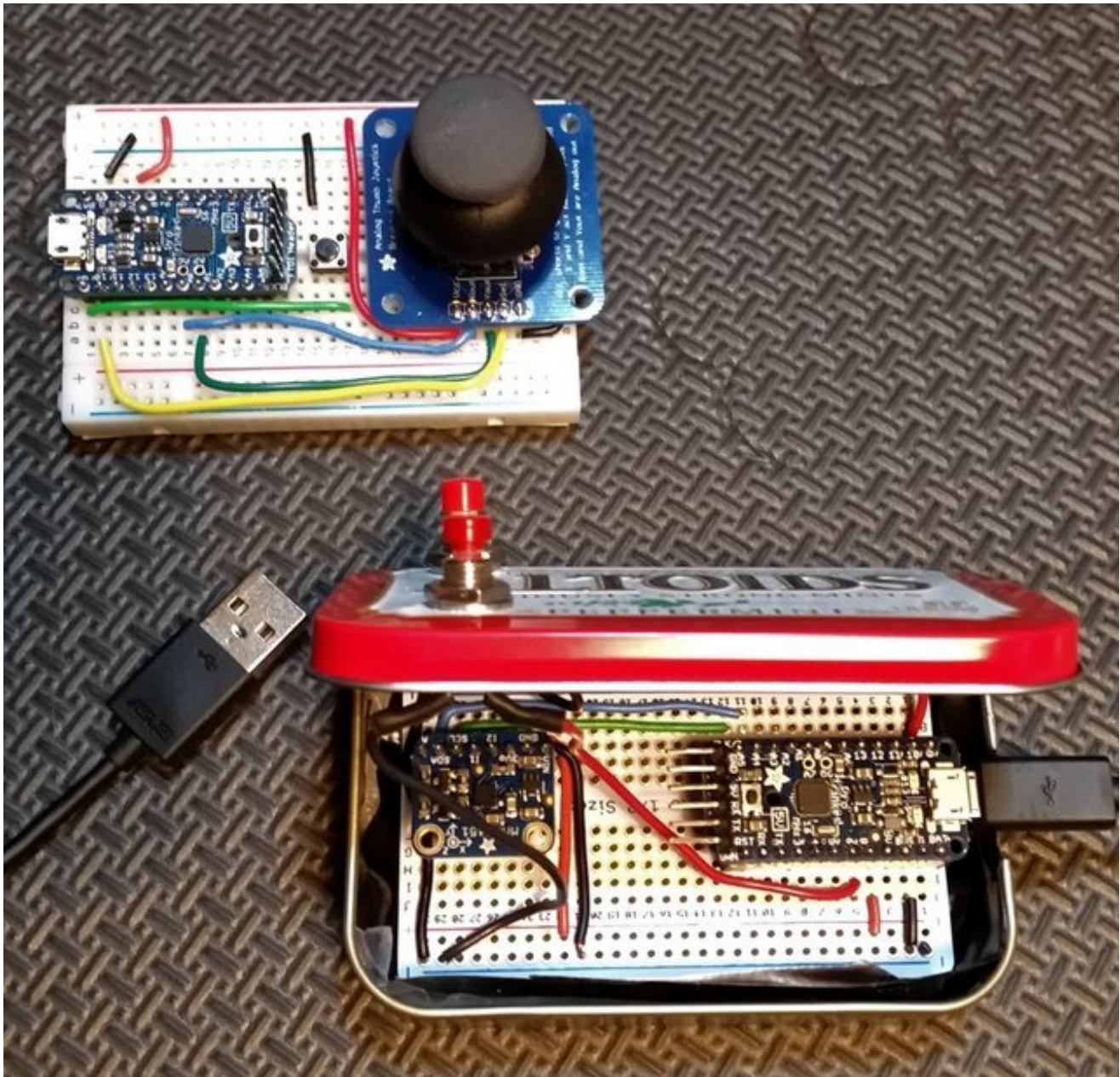

We also have these in a few different other sizes and styles, like a 'quarter sized' one that is a bit larger than the tiny breadboard and comes with power rails:

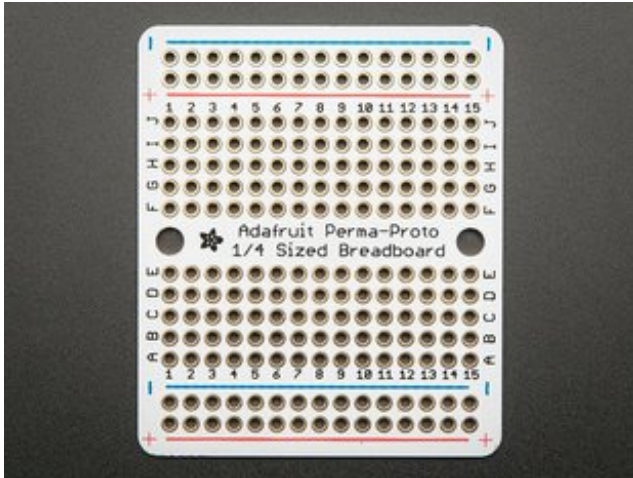

Adafruit Perma-Proto Quarter-sized Breadboard PCB - Single

PRODUCT ID: 1608

Customers have asked us to carry basic perf-board, but we never liked the look of most basic perf: its always crummy quality, with pads that flake off and no labeling. Then we thought...

<http://adafru.it/oIC>

\$2.95

IN STOCK

Full sized breadboard sized, huge with tons of space!

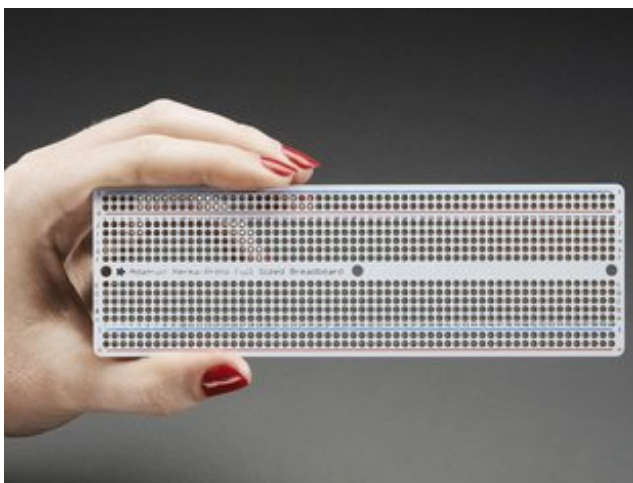

Adafruit Perma-Proto Full-sized Breadboard PCB - Single

PRODUCT ID: 1606

Customers have asked us to carry basic perf-board, but we never liked the look of most basic perf: its always crummy quality, with pads that flake off and no labeling. Then we thought...

<http://adafru.it/rdy>

\$6.95

IN STOCK

And two that match up with common mint tins

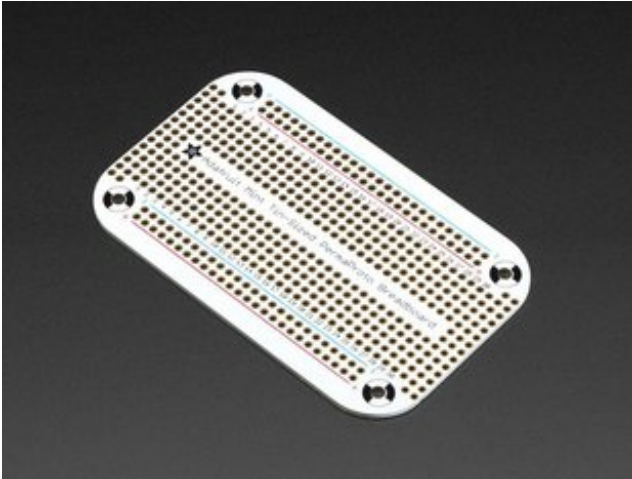

Adafruit Perma-Proto Mint Tin Size Breadboard PCB

PRODUCT ID: 723

Making a project that will fit into a "Altoids" Mint Tin? Put down that PCB shear and pick up a Perma-Proto in the new exciting minty shape! Customers have asked us to carry...

<http://adafru.it/rdz>

\$5.95

IN STOCK



Adafruit Perma-Proto Small Mint Tin Size Breadboard PCB - 3 pack

PRODUCT ID: 1214

Making a project that will fit into a "Altoids Small's" Mint Tin? Or maybe you just need a

small amount of prototyping space and a larger breadboard size is too big? Put down...

<http://adafru.it/rdA>

\$7.95

IN STOCK

Breadboard Tips & Tricks

Connecting the two power rails

The two sets of rails are not internally connected. Since I almost always want at least the grounds connected, I like to use two solid core wires to make the two sides of rails carry the same voltages

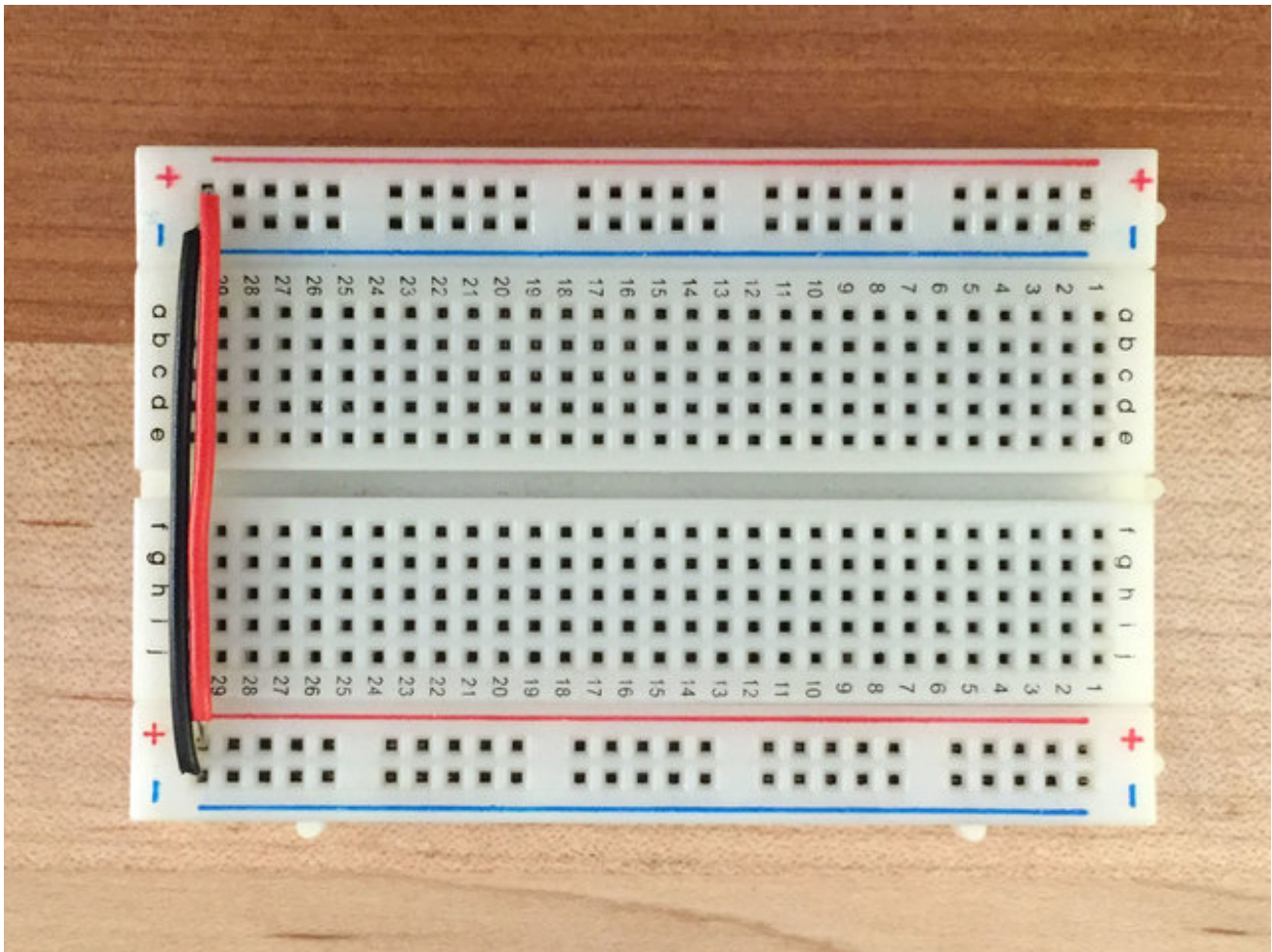

Heck, I usually leave these on permanently between projects!

While you're at it, it's a good idea to add some capacitors to the rails. Electrolytic and ceramic capacitors are usually 2.5mm spacing so they fit right in. A 10-100uF electrolytic paired with a 0.1-1uF ceramic on either side will often be enough for most simple circuitry.

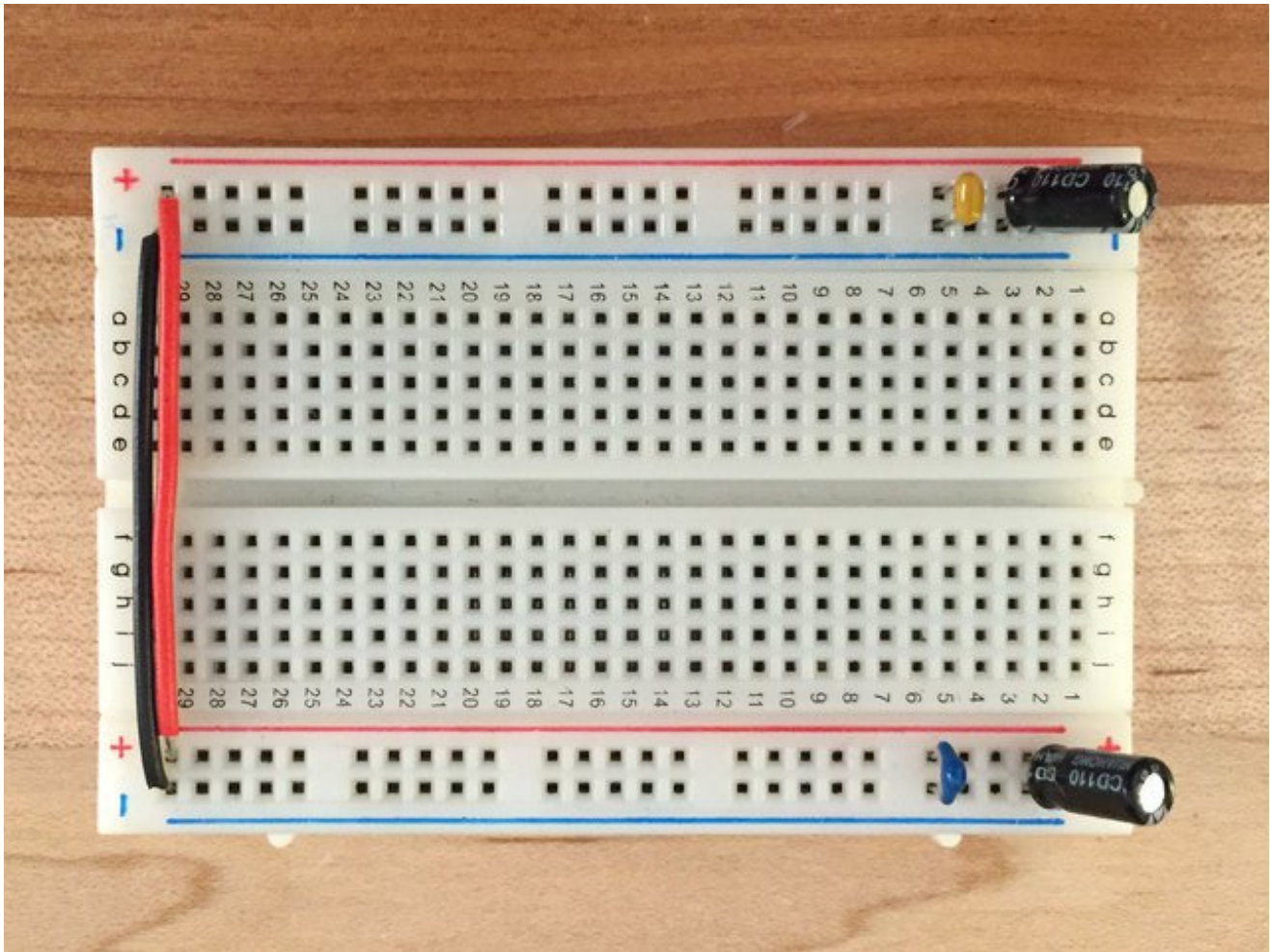

Watch Out For Split Rails!

Sometimes you'll get full size breadboards that do not have solid continuous rails. This can really trip up beginners because they are used to the ground strip being solid all the way down, but there's a gap!

Check the silkscreen of the breadboard, if the blue and red lines have a gap, you have a split rail

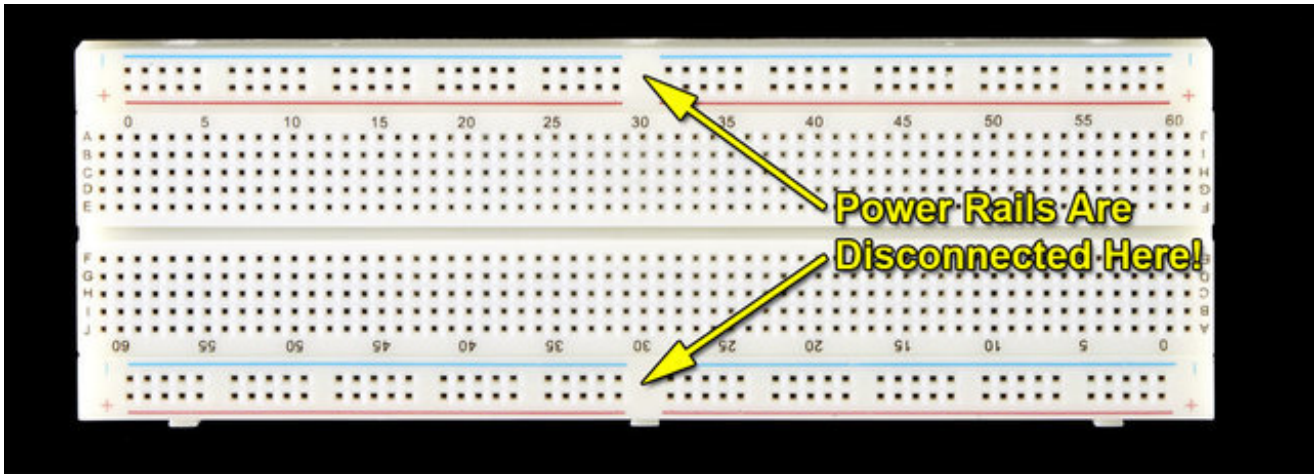

But some breadboards do not have the nice colored lines so you'll have to test with a multimeter or some other way to verify. Use little wires to jumper over the gap, if you want continuous conductivity

Using Fritzing!

We use [Fritzing for our diagrams \(http://adafruit.it/rdB\)](http://adafruit.it/rdB), which can make it very easy to plan out your breadboarding project without even picking up a wire cutter. It doesn't do simulation or anything, it's just for diagramming - but you can go from schematic to breadboard or the other way around and then also generate PCBs.

For complex projects, it can take a crazy tangle of wires and lets you clearly visualize all the connections!

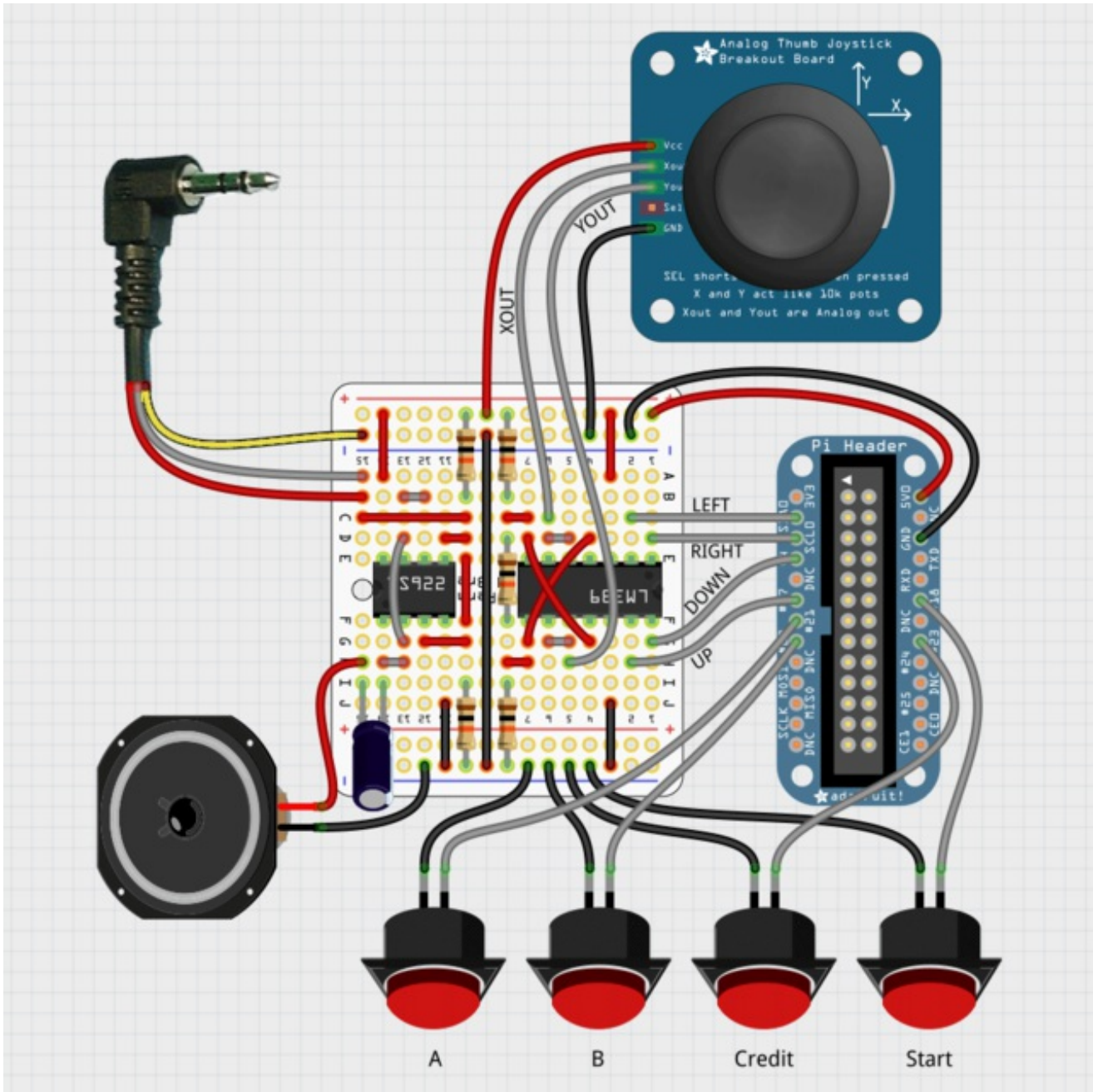

An extra nicety when prototyping with Fritzing is and that the breadboards pins that are "in use" are highlighted green. This can help remind you of what rows are available for other components

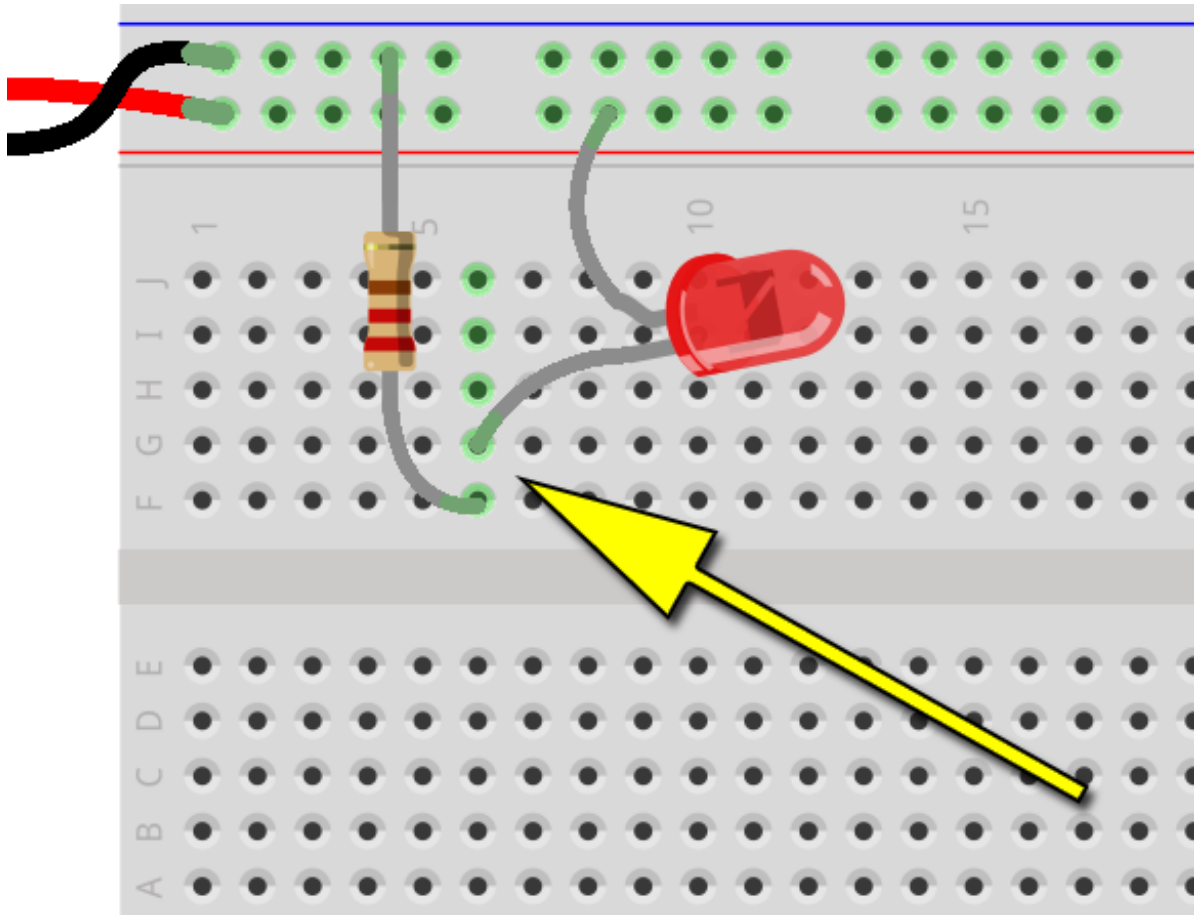

Another handy thing is that you can click on the breadboard rows and they will highlight all the connected pins *including other rows that are internally connected through components!* For example, Fritzing knows about the internal connection in 12mm tactile switches:

