

MASSE OHNE TOLERANZ SIND KEINE PRUEFMASSE
 DIMS. WITHOUT TOLERANCE ARE NOT CONTROL DIMS.

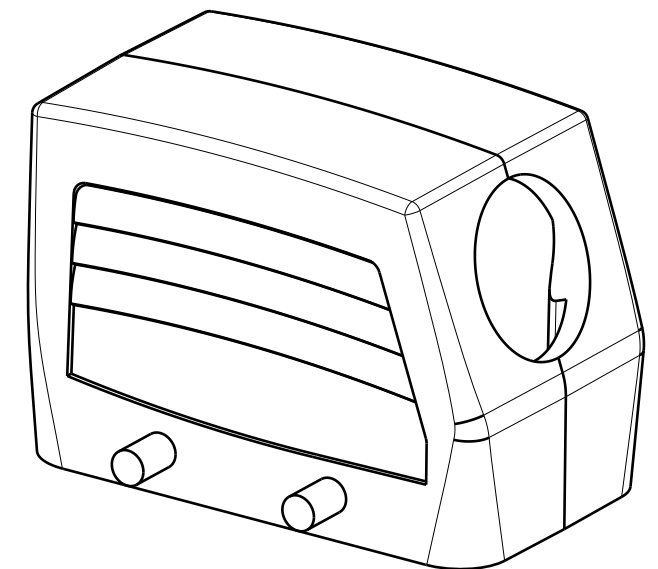
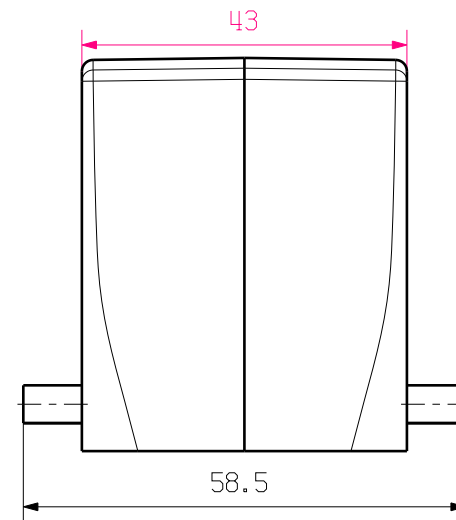
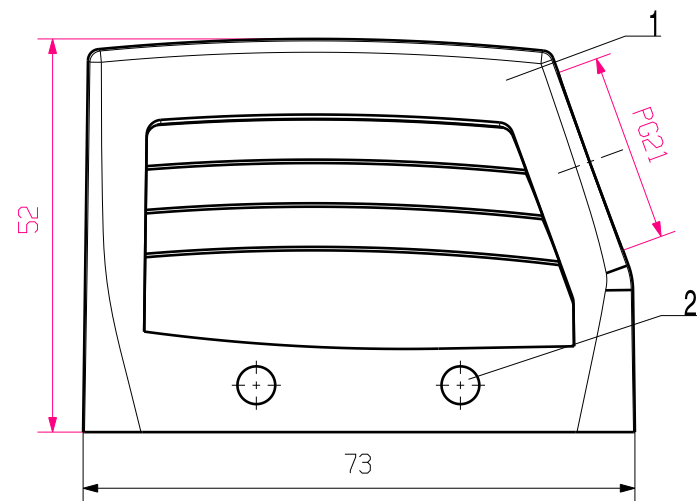

2	LOCKING BOLTS	STAINLESS STEEL
1	PLUG HOOD HOUSING	ALUMINIUM WITH POWDER COATING
ROHSTOFF-NR. R.PART NO.	TYP PART NAME	WERKSTOFF MATERIAL

CAT.NO.: 1654090000

MAX. NRN./NOS. ?		MODIFICATION		Weidmüller		DRAWING NO.	ISSUE NO.
SCALE: 1/1	DRAWN	DATE	NAME	HDC 10B TSBU 1PG21G STECKERGEHAEUSE PLUG HOOD HOUSING			
SUPERSEDES:	RESPONSIBLE	08.11.2005	LIU_F				
SUPERSEDED BY:	CHECKED	30.11.2005	ZHANG_T				
	APPROVED			PRODUCT FILE:			

WEITERGABE SOWIE VERVIELFÄLTIGUNG DIESES DOKUMENTS, VERWERTUNG UND MITTEILUNG SEINES INHALTS SIND VERBOTEN, SOWEIT NICHT AUSDRUECKLICH GESTATET.
 ZUWIDERHANDLUNGEN VERPFLICHTEN ZU SCHADENERSATZ. ALLE RECHTE FUER DEN FALL DER PATENT-, GEBRAUCHSMUSTER- ODER GESCHMACKSMUSTEREINTRAGUNG VORBEHALTEN.
 THE REPRODUCTION, DISTRIBUTION AND UTILIZATION OF THIS DOCUMENT AS WELL AS THE COMMUNICATION OF ITS CONTENTS TO OTHERS WITHOUT EXPLICIT AUTHORIZATION IS PROHIBITED.
 OFFENDERS WILL BE HELD LIABLE FOR THE PAYMENT OF DAMAGES. ALL RIGHTS RESERVED IN THE EVENT OF THE GRANT OF A PATENT, UTILITY MODEL OR DESIGN.