

1 2 3 4 5 6

A

B

C

D

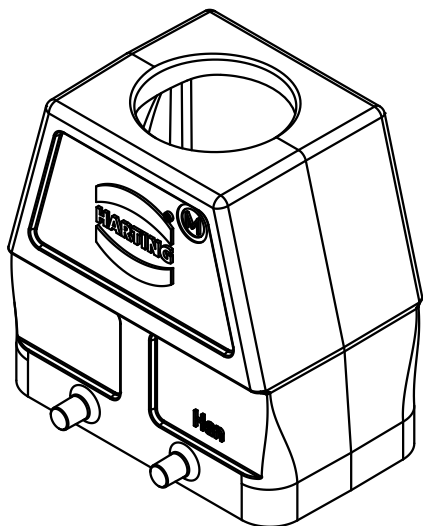
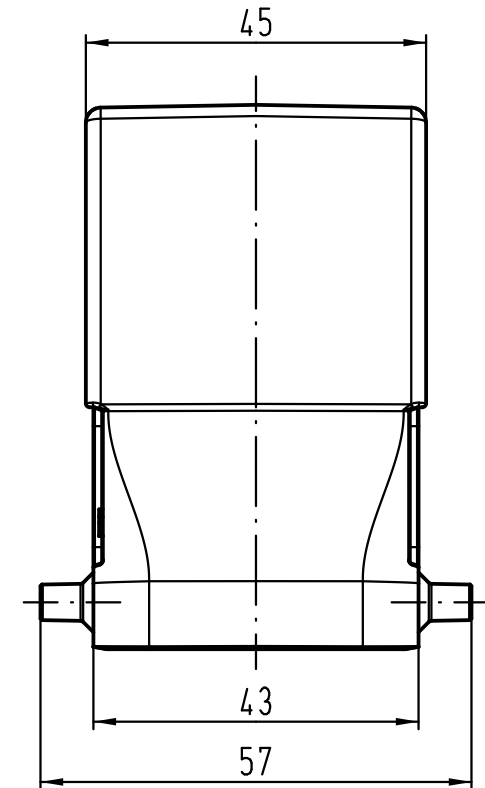
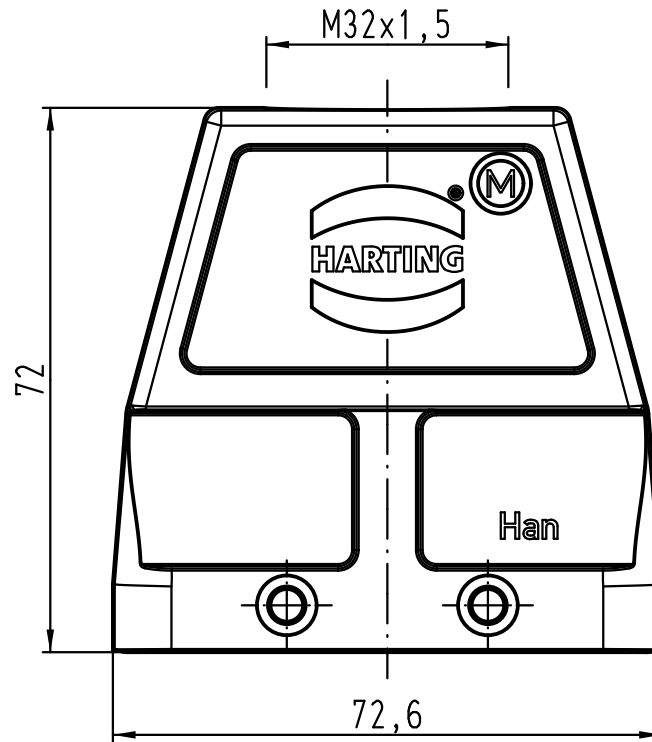

All Dimensions in mm Original Size DIN A 4			Techn. Character.			Nicht tolerierte Maß/Free size tolerances			
				Dat.	Name	Maßstab/Scale 1:1	Han 10B-gg-M32 Gehäuse/hood		
			Detail.	19.02.09	ML				
			Insp.		Sch				
			Stand.						
B	19.03.12	Ho	HARTING Electric GmbH & Co. KG				TB 19 30 010 0427		
A			D-32339 Espelkamp						
Mod.	Dat.	Name							
							Sub. f. TB 19 30 010 0427 v. 16.11.00		Blatt/page