



*Do-It-Yourself Option Available*

### FEATURES

- Up to 10V Input Voltage
- 5V, 12V Output Options
- 3A Continuous Output Current
- Open Design Files and BOM
- 600kHz Fixed Frequency
- High Efficiency
- Over-Temperature Protection

### ORDERING INFORMATION

Part Number	Input Voltage (V)	Output Voltage (V)	Output Current (A)
MEZD41503A-A	2.7 - 4.2	5	3
MEZD41503A-B	2.7 - 10	12	3

### mEZD4150xA-x FAMILY PRODUCTS

Part Number	Input Voltage (V)	Output Voltage (V)	Output Current (A)
mEZD41501A-X	2.7 - 13	5, 12, 15	1
mEZD41502A-X	2.7 - 13	5, 12, 15	2
mEZD41503A-X	2.7 - 10	5, 12	3

### ELECTRICAL CHARACTERISTICS

Input Voltage Range	mEZD41503A-A	2.7V to 4.2V
	mEZD41503A-B	3.7V to 10V
Output Voltage Set Accuracy		±2.2%
Output Voltage Ripple	$V_{IN} = 3.3V, V_{OUT} = 5V, I_{OUT} = 3A$	37mV (Typ.)
	$V_{IN} = 6.6V, V_{OUT} = 12V, I_{OUT} = 3A$	80mV (Typ.)
Line Regulation	$V_{IN}$ from MIN to MAX, $I_{OUT} = 3A$	±0.2%
Load Regulation	$I_{OUT}$ from MIN to MAX, $V_{IN} = 6.6V$	±0.5%
Efficiency	$V_{IN} = 3.3V, V_{OUT} = 5V, I_{OUT} = 3A$	96.7%
	$V_{IN} = 6.6V, V_{OUT} = 15V, I_{OUT} = 3A$	97.2%
Switching Frequency	Typical switching frequency	600kHz
Short-Circuit Protection	No output short allowed	-
Operating Temperature Range		0 to 85°C
Over-Temperature Protection	OTP	150°C
Calculated MTBF	MIL-HDBK-217F	$4185 \times 10^3$ hrs

**TYPICAL PERFORMANCE CURVES**

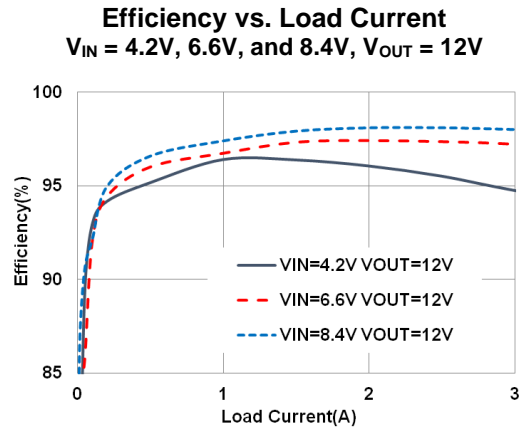
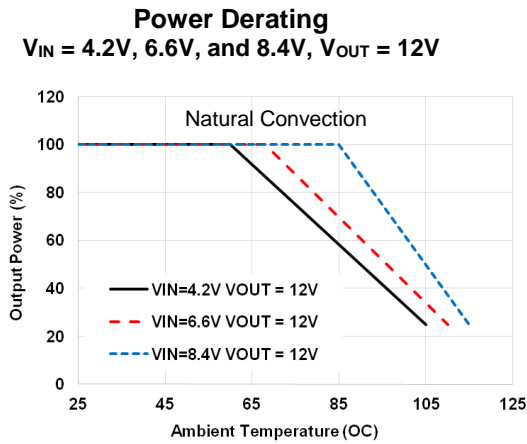
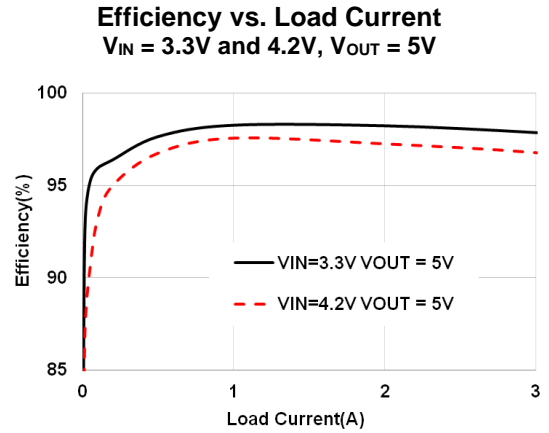
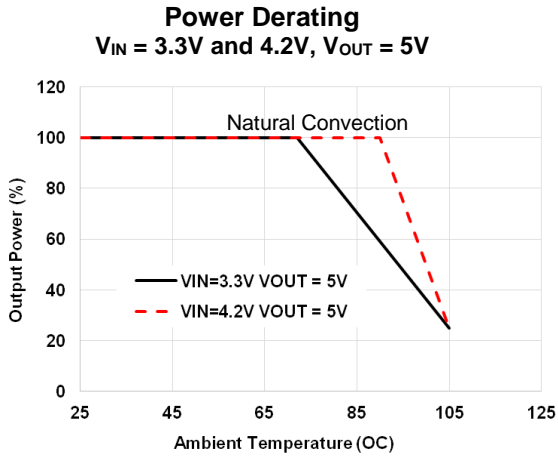

### DO-IT-YOURSELF SCHEMATIC

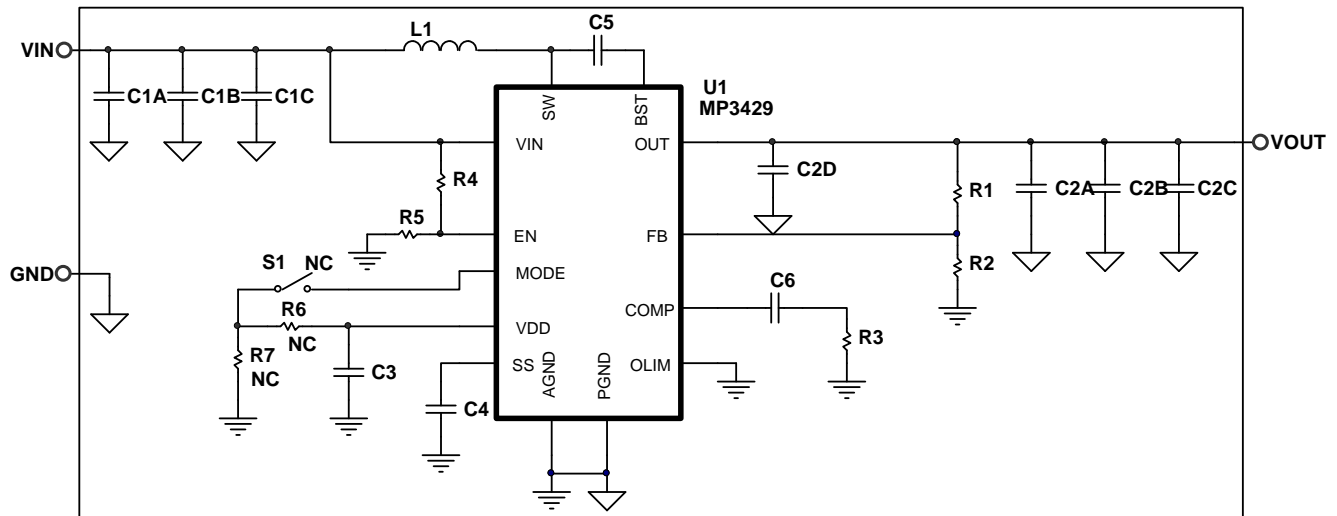

### BILL OF MATERIALS

Item	Qty	RefDes	Value	Description	Package	Manufacturer	Manufacturer P/N
1	3	C1A, C1B, C1C	22μF	Ceramic Cap., 10V, X7R (A)	1206	Murata	GRM31CR71A226ME15L
				Ceramic Cap., 25V, X7R (B)	1206	Murata	GRM31ER71E226KE15L
2	3	C2A, C2B, C2C	22μF	Ceramic Cap., 10V, X7R (A)	1210	Murata	GRM32ER71A226KE20L
				Ceramic Cap., 25V, X7R (B)	1210	Murata	GRM32ER71E226KE15L
3	2	C2D, C5	100nF	Ceramic Cap., 25V, X7R	0603	Murata	GRM188R71E104KA01D
6	1	C3	4.7μF	Ceramic Cap., 6.3V, X5R	0603	Murata	GRM188R60J475KE19D
5	1	C4	22nF	Ceramic Cap., 25V, X7R	0603	Murata	GRM188R71E223JA01D
7	1	C6	8.2nF(A) 6.8nF(B)	Ceramic Cap., 50V, X7R	0603	Murata	GRM188R71H822KA01D GRM188R71H682KA01D
8	1	R1	750kΩ	Film Res, 1%	0603	YAGEO	RC0603FR-07750KL
9	1	R2	187kΩ(A) 68kΩ(B)	Film Res, 1%	0603	YAGEO	RC0603FR-07187KL RC0603FR-0768KL
10	1	R3	3kΩ(A) 10kΩ(B)	Film Res, 1%	0603	YAGEO	RC0603FR-073KL RC0603FR-0710KL
11	1	R4	30kΩ	Film Res, 1%	0603	YAGEO	RC0603FR-0730KL
12	1	R5	34.8kΩ	Film Res, 1%	0603	YAGEO	RC0603FR-0734K8L
13	0	R6, R7	NC				
14	1	L1	1.5μH	Irms = 19A, RDC = 3.3mΩ	11.5x10mm	Sumida	104CDMCCDS-1R5MC-ND
15	0	S1	NC				
16	1	U1	MP3429	Boost Converter	QFN 3x4mm	MPS	MP3429GL
17	1	VIN,VOUT,GND	Connector	6-Pin Connector	2.54mm	Würth	

#### NOTE:

A, B, C denote this value is specifically for mEZD41503A-A, mEZD41503A-B respectively.

**PRODUCT PACKAGE AND DIMENSIONS**

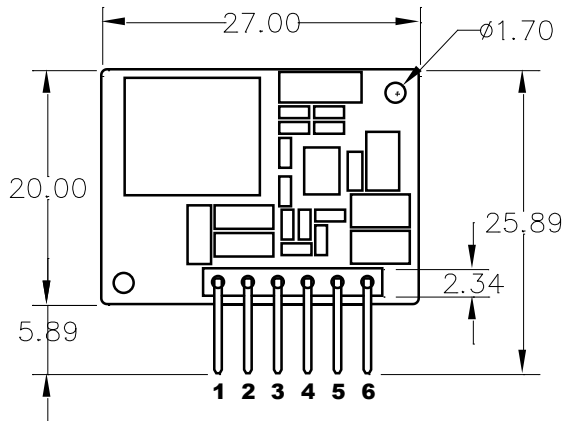

**TOP VIEW**

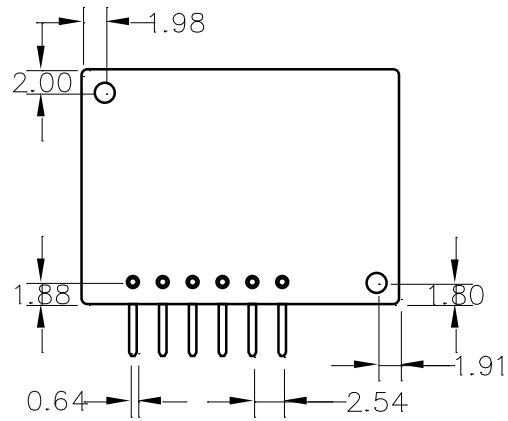

**BOTTOM VIEW**

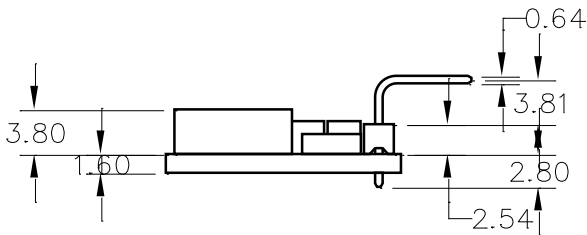

**SIDE VIEW**

Pin	Designation	Function
1, 2	VIN	Input Voltage
3, 4	GND	Power Ground
5, 6	VOUT	Output Voltage

**NOTE:**

Contact factory for different sizes of the boards (Quantity >2k).

For more information, Gerber files, and PCB layout, please contact [mEZsupport@monolithicpower.com](mailto:mEZsupport@monolithicpower.com)