



Is Now Part of



**ON Semiconductor®**

To learn more about ON Semiconductor, please visit our website at

[www.onsemi.com](http://www.onsemi.com)

ON Semiconductor and the ON Semiconductor logo are trademarks of Semiconductor Components Industries, LLC dba ON Semiconductor or its subsidiaries in the United States and/or other countries. ON Semiconductor owns the rights to a number of patents, trademarks, copyrights, trade secrets, and other intellectual property. A listing of ON Semiconductor's product/patent coverage may be accessed at [www.onsemi.com/site/pdf/Patent-Marking.pdf](http://www.onsemi.com/site/pdf/Patent-Marking.pdf). ON Semiconductor reserves the right to make changes without further notice to any products herein. ON Semiconductor makes no warranty, representation or guarantee regarding the suitability of its products for any particular purpose, nor does ON Semiconductor assume any liability arising out of the application or use of any product or circuit, and specifically disclaims any and all liability, including without limitation special, consequential or incidental damages. Buyer is responsible for its products and applications using ON Semiconductor products, including compliance with all laws, regulations and safety requirements or standards, regardless of any support or applications information provided by ON Semiconductor. "Typical" parameters which may be provided in ON Semiconductor data sheets and/or specifications can and do vary in different applications and actual performance may vary over time. All operating parameters, including "Typicals" must be validated for each customer application by customer's technical experts. ON Semiconductor does not convey any license under its patent rights nor the rights of others. ON Semiconductor products are not designed, intended, or authorized for use as a critical component in life support systems or any FDA Class 3 medical devices or medical devices with a same or similar classification in a foreign jurisdiction or any devices intended for implantation in the human body. Should Buyer purchase or use ON Semiconductor products for any such unintended or unauthorized application, Buyer shall indemnify and hold ON Semiconductor and its officers, employees, subsidiaries, affiliates, and distributors harmless against all claims, costs, damages, and expenses, and reasonable attorney fees arising out of, directly or indirectly, any claim of personal injury or death associated with such unintended or unauthorized use, even if such claim alleges that ON Semiconductor was negligent regarding the design or manufacture of the part. ON Semiconductor is an Equal Opportunity/Affirmative Action Employer. This literature is subject to all applicable copyright laws and is not for resale in any manner.



July 2015

# FOD8012A High CMR, Bi-Directional, Logic Gate Optocoupler

## Features

- Half Duplex, Bi-Directional
- 20 kV/μs Minimum Common Mode Rejection
- High Speed:
  - 15 Mbit/sec Data Rate (NRZ)
  - 60 ns Maximum Propagation Delay
  - 15 ns Maximum Pulse Width Distortion
  - 30 ns Maximum Propagation Delay Skew
- 3.3 V and 5 V CMOS Compatibility
- Extended Industrial Temperature Range, -40 to +110°C Temperature Range
- Safety and Regulatory Approvals
  - UL1577, 3750 VAC<sub>RMS</sub> for 1 min.
  - DIN EN/IEC60747-5-2 (approval pending)

## Applications

- Industrial Fieldbus Communications
  - DeviceNet, CAN, RS485
- Microprocessor System Interface
  - SPI, I<sup>2</sup>C
- Programmable Logic Control
- Isolated Data Acquisition System
- Voltage Level Translator

## Description

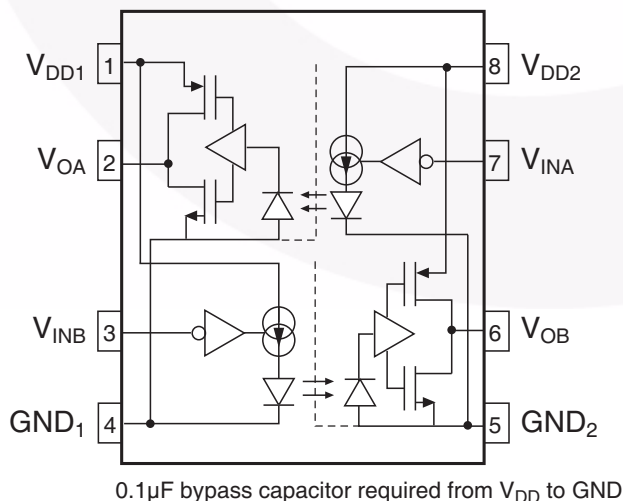
The FOD8012A is a half duplex, bi-directional, high-speed logic gate Optocoupler, which supports isolated communications allowing digital signals to communicate between systems without conducting ground loops or hazardous voltages. It utilizes Fairchild's patented coplanar packaging technology, Optoplanar<sup>®</sup>, and optimized IC design to achieve minimum 20 kV/μs Common Mode Noise Rejection (CMR) rating.

This high-speed logic gate optocoupler is highly integrated with 2 optically coupled channels arranged in bi-directional configuration, and housed in a compact 8-pin small outline package. Each optocoupler channel consists of a high-speed AlGaAs LED driven by a CMOS buffer IC coupled to a CMOS detector IC. The detector IC comprises of an integrated photodiode, a high-speed trans-impedance amplifier and a voltage comparator with an output driver. The CMOS technology coupled to the high efficiency of the LED achieves low power consumption as well as very high speed (60 ns propagation delay, 15 ns pulse width distortion).

## Related Resources

- [FOD8001, High Noise Immunity, 3.3 V/5 V Logic Gate Optocoupler Datasheet](#)
- [www.fairchildsemi.com/products/optoelectronics/](http://www.fairchildsemi.com/products/optoelectronics/)

## Functional Schematic



## Truth Table

V <sub>IN</sub>	LED	V <sub>O</sub>
High	OFF	High
Low	ON	Low

When not communicating, V<sub>IN</sub> must be in static high logic condition.

## Pin Definitions

Pin Number	Pin Name	Description
1	V <sub>DD1</sub>	<b>Supply Voltage</b> to Channel-A detector IC and Channel-B buffer IC
2	V <sub>OA</sub>	<b>Output Voltage</b> from Channel-A detector IC
3	V <sub>INB</sub>	<b>Input Voltage</b> to Channel-B buffer IC
4	GND <sub>1</sub>	<b>Ground</b> for Channel-A detector IC and Channel-B buffer IC
5	GND <sub>2</sub>	<b>Ground</b> for Channel-A buffer IC and Channel-B detector IC
6	V <sub>OB</sub>	<b>Output Voltage</b> from Channel-B detector IC
7	V <sub>INA</sub>	<b>Input Voltage</b> to Channel-A buffer IC
8	V <sub>DD2</sub>	<b>Supply Voltage</b> to Channel-A buffer IC and Channel-B detector IC

## Absolute Maximum Ratings

Stresses exceeding the absolute maximum ratings may damage the device. The device may not function or be operable above the recommended operating conditions and stressing the parts to these levels is not recommended. In addition, extended exposure to stresses above the recommended operating conditions may affect device reliability. The absolute maximum ratings are stress ratings only. T<sub>A</sub> = 25°C unless otherwise specified.

Symbol	Parameter	Value	Unit
T <sub>STG</sub>	Storage Temperature	-40 to +125	°C
T <sub>OPR</sub>	Operating Temperature	-40 to +110	°C
T <sub>J</sub>	Junction Temperature	-40 to +130	°C
T <sub>SOL</sub>	Lead Solder Temperature (Refer to Reflow Temperature Profile)	260 for 10sec	°C
V <sub>DD1</sub> , V <sub>DD2</sub>	Supply Voltage	0 to 6.0	V
V <sub>IA</sub> , V <sub>IB</sub>	Input Voltage	-0.5 to V <sub>DD</sub> +0.5	V
I <sub>IA</sub> , I <sub>IB</sub>	Input DC Current	-10 to +10	μA
V <sub>OA</sub> , V <sub>OB</sub>	Output Voltage	-0.5 to V <sub>DD</sub> +0.5	V
I <sub>OA</sub> , I <sub>OB</sub>	Average Output Current	10	mA
PD <sub>I</sub>	Input Power Dissipation <sup>(1)</sup>	60	mW
PD <sub>O</sub>	Output Power Dissipation <sup>(1)</sup>	60	mW

## Recommended Operating Conditions

The Recommended Operating Conditions table defines the conditions for actual device operation. Recommended operating conditions are specified to ensure optimal performance to the datasheet specifications. Fairchild does not recommend exceeding them or designing to Absolute Maximum Ratings.

Symbol	Parameter	Min.	Max.	Unit
T <sub>A</sub>	Ambient Operating Temperature	-40	+110	°C
V <sub>DD1</sub> , V <sub>DD2</sub>	Supply Voltages (3.3 V Operation) <sup>(2)</sup>	3.0	3.6	V
	Supply Voltages (5.0 V Operation) <sup>(2)</sup>	4.5	5.5	V
V <sub>IH</sub>	Logic High Input Voltage	2.0	V <sub>DD</sub>	V
V <sub>IL</sub>	Logic Low Input Voltage	0	0.8	V
t <sub>r</sub> , t <sub>f</sub>	Input Signal Rise and Fall Time		1.0	ms

## Isolation Characteristics

Apply over all recommended conditions, typical value is measured at  $T_A = 25^\circ\text{C}$

Symbol	Parameter	Conditions	Min.	Typ.	Max.	Unit
$V_{ISO}$	Input-Output Isolation Voltage	freq = 60 Hz, t = 1.0 min, $I_{I-O} \leq 10 \mu\text{A}^{(3)(4)}$	3750			$V_{acRMS}$
$R_{ISO}$	Isolation Resistance	$V_{I-O} = 500 \text{ V}^{(3)}$	$10^{11}$			$\Omega$
$C_{ISO}$	Isolation Capacitance	$V_{I-O} = 0 \text{ V}$ , freq = 1.0 MHz <sup>(3)</sup>		0.2		pF

## Electrical Characteristics

$T_A = -40^\circ\text{C}$  to  $+110^\circ\text{C}$ ,  $3.0 \text{ V} \leq V_{DD} \leq 5.5 \text{ V}$ , unless otherwise specified.

Apply over all recommended conditions, typical value is measured at  $V_{DD1} = V_{DD2} = +3.3 \text{ V}$ ,  $T_A = 25^\circ\text{C}$

Symbol	Parameter	Conditions	Min.	Typ.	Max.	Unit
$I_{DD1L}, I_{DD2L}$	Logic Low Supply Current	$V_{IA}, V_{IB} = 0 \text{ V}$		5.8	8.0	mA
$I_{DD1H}, I_{DD2H}$	Logic High Supply Current	$V_{IA}, V_{IB} = V_{DD}$		2.5	4.0	mA
$I_{IA}, I_{IB}$	Input Current		-10		+10	$\mu\text{A}$
$V_{OH}$	Logic High Output Voltage	$I_O = -20 \mu\text{A}$ , $V_{DD} = 3.3 \text{ V}$ , $V_I = V_{IH}$	3.2	3.3		V
		$I_O = -4 \text{ mA}$ , $V_{DD} = 3.3 \text{ V}$ , $V_I = V_{IH}$	3.0	3.1		V
		$I_O = -20 \mu\text{A}$ , $V_{DD} = 5 \text{ V}$ , $V_I = V_{IH}$	4.9	5.0		V
		$I_O = -4 \text{ mA}$ , $V_{DD} = 5 \text{ V}$ , $V_I = V_{IH}$	4.7	4.8		V
$V_{OL}$	Logic Low Output Voltage	$I_O = 20 \mu\text{A}$ , $V_{DD} = 3.3 \text{ V}$ or $5 \text{ V}$ , $V_I = V_{IL}$		0	0.1	V
		$I_O = 4 \text{ mA}$ , $V_{DD} = 3.3 \text{ V}$ or $5 \text{ V}$ , $V_I = V_{IL}$		0.26	0.6	V

## Switching Characteristics

$T_A = -40^\circ\text{C}$  to  $+110^\circ\text{C}$ ,  $3.0\text{ V} \leq V_{DD} \leq 5.5\text{ V}$ , unless otherwise specified.

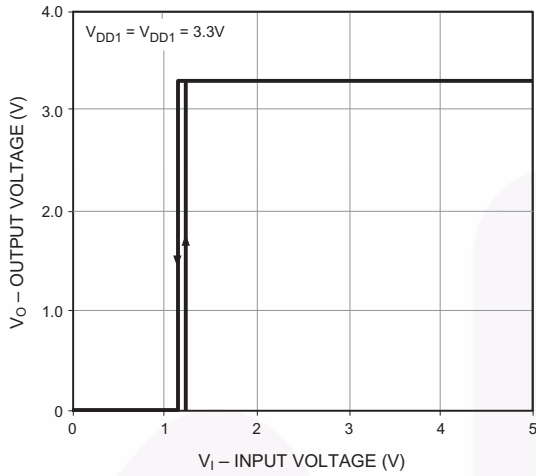
Apply over all recommended conditions, typical value is measured at  $V_{DD1} = V_{DD2} = +3.3\text{ V}$ ,  $T_A = 25^\circ\text{C}$

Symbol	Parameter	Conditions	Min.	Typ.	Max.	Unit
Data Rate					15	Mbit/s
$t_{PHL}$	Propagation Delay Time to Logic Low Output	$PW = 66.7\text{ ns}$ , $C_L = 15\text{ pF}$		37	60	ns
$t_{PLH}$	Propagation Delay Time to Logic High Output	$PW = 66.7\text{ ns}$ , $C_L = 15\text{ pF}$		40	60	ns
PWD	Pulse Width Distortion, $ t_{PHL} - t_{PLH} $	$PW = 66.7\text{ ns}$ , $C_L = 15\text{ pF}^{(5)}$		3	15	ns
$t_{PSK(CC)}$	Channel-Channel Skew	$PW = 66.7\text{ ns}$ , $C_L = 15\text{ pF}^{(6)}$		12	25	ns
$t_{PSK(PP)}$	Part-Part Skew	$PW = 66.7\text{ ns}$ , $C_L = 15\text{ pF}^{(7)}$			30	ns
$t_R$	Output Rise Time (10% to 90%)	$PW = 66.7\text{ ns}$ , $C_L = 15\text{ pF}$		6.5		ns
$t_F$	Output Fall Time (90% to 10%)	$PW = 66.7\text{ ns}$ , $C_L = 15\text{ pF}$		6.5		ns
$ CM_H $	Common Mode Transient Immunity at Output High	$V_I = V_{DD1}$ , $V_O > 0.8 V_{DD1}$ , $V_{CM} = 1000\text{ V}^{(8)}$	20	40		kV/ $\mu\text{s}$
$ CM_L $	Common Mode Transient Immunity at Output Low	$V_I = 0\text{ V}$ , $V_O < 0.8\text{ V}$ , $V_{CM} = 1000\text{ V}^{(8)}$	20	40		kV/ $\mu\text{s}$

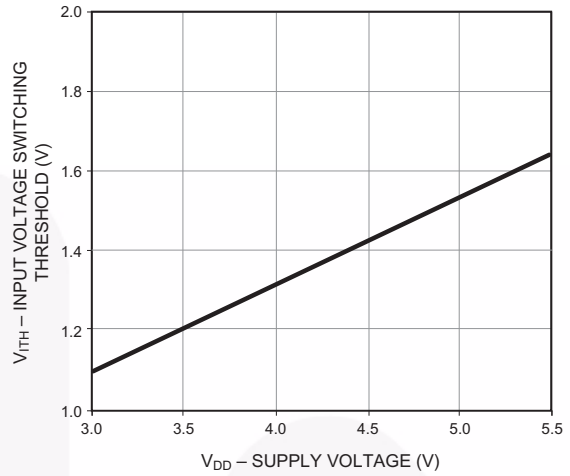
### Notes:

- No derating required.
- 0.1  $\mu\text{F}$  bypass capacitor must be connected between Pin 1 and 4, and 5 and 8. The capacitors should be kept close to the supply pins.
- Device is considered a two terminal device: Pins 1, 2, 3 and 4 are shorted together and Pins 5, 6, 7 and 8 are shorted together.
- 3,750  $V_{AC_{RMS}}$  for 1 minute duration is equivalent to 4,500  $V_{AC_{RMS}}$  for 1 second duration.
- PWD is equal to the magnitude of the worst case difference in  $t_{PHL}$  and/or  $t_{PLH}$  that will be seen for one channel switching, while holding the other channel output at a low or high state, or while both channels are in synchronous data transmission mode.
- $t_{PSK(CC)}$  is equal to the magnitude of the worst case difference in  $t_{PHL}$  and/or  $t_{PLH}$  that will be seen between the two channels within a single device.
- $t_{PSK(PP)}$  is equal to the magnitude of the worst case difference in  $t_{PHL}$  and/or  $t_{PLH}$  that will be seen between any two units from the same manufacturing date code that are operated at same case temperature, at same operating conditions, with equal loads.
- Common mode transient immunity at output high is the maximum tolerable positive  $dV_{cm}/dt$  on the leading edge of the common mode impulse signal,  $V_{cm}$ , to assure that the output will remain high. Common mode transient immunity at output low is the maximum tolerable negative  $dV_{cm}/dt$  on the trailing edge of the common pulse signal,  $V_{cm}$ , to assure that the output will remain low.

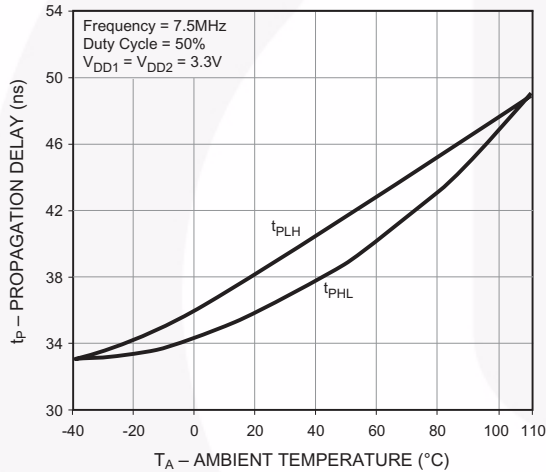
## Typical Performance Curves



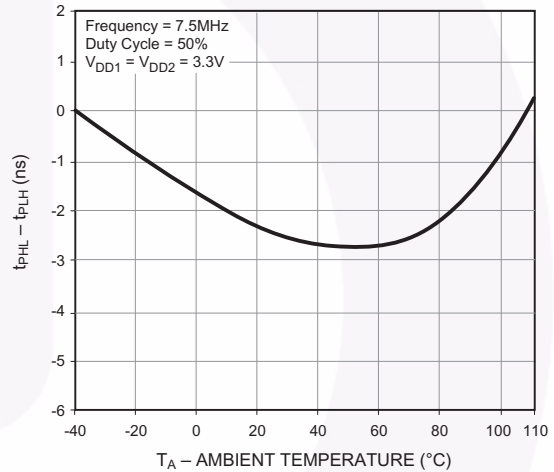
**Fig. 1 Typical Output Voltage vs. Input Voltage (Channel A & B)**



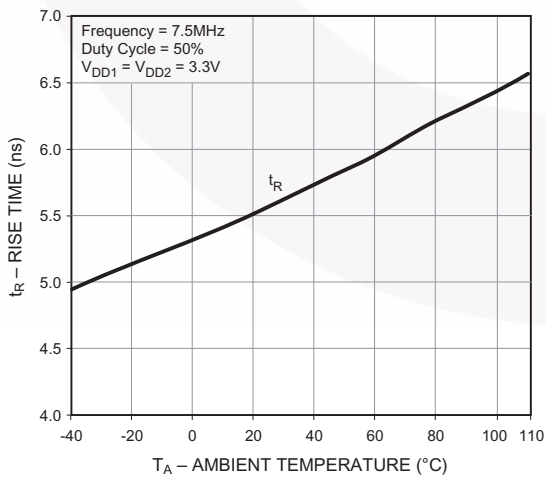
**Fig. 2 Typical Input Voltage Switching Threshold vs. Input Supply Voltage (Channel A & B)**



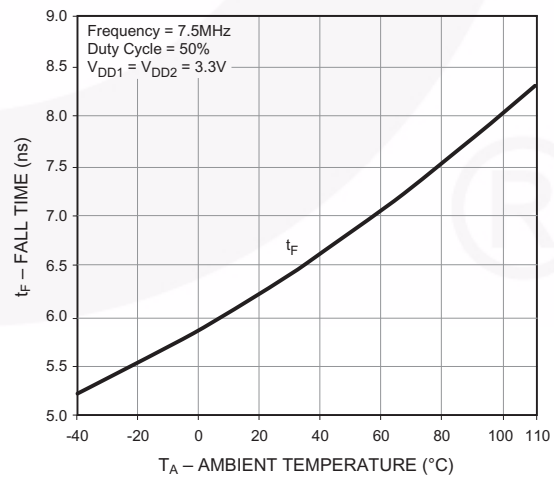
**Fig. 3 Typical Propagation Delay vs. Ambient Temperature (Channel A & B)**



**Fig. 4 Typical  $t_{PHL} - t_{PLH}$  vs. Ambient Temperature (Channel A & B)**

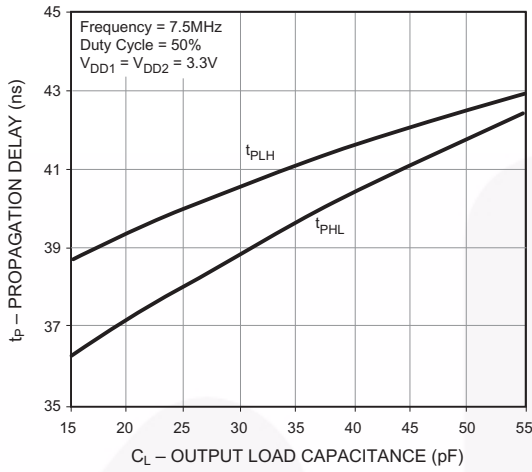


**Fig. 5 Typical Rise Time vs. Ambient Temperature (Channel A & B)**

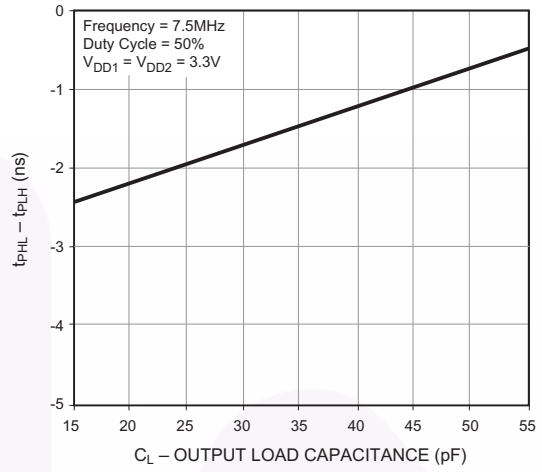


**Fig. 6 Typical Fall Time vs. Ambient Temperature (Channel A & B)**

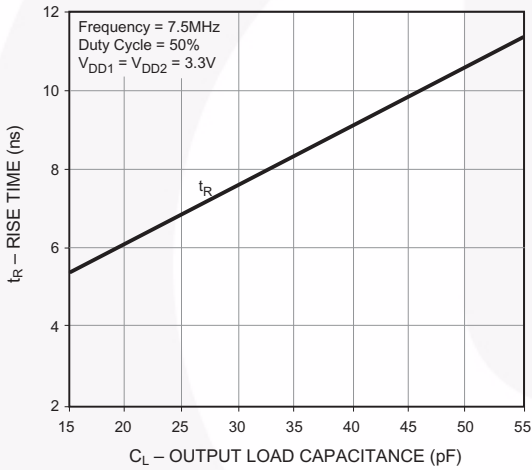
**Typical Performance Curves (Continued)**



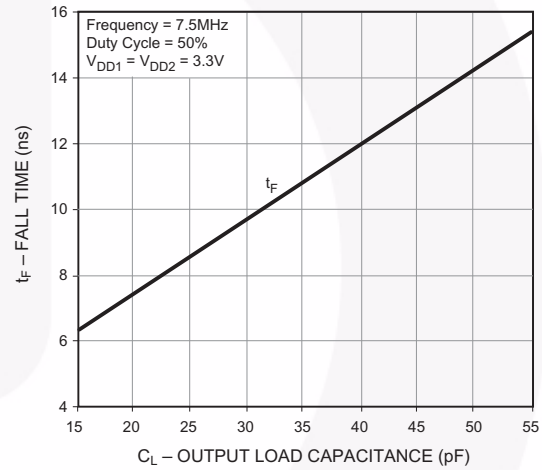
**Fig. 7 Typical Propagation Delay vs. Output Load Capacitance (Channel A & B)**



**Fig. 8 Typical t<sub>pHL</sub> - t<sub>pLH</sub> vs. Output Load Capacitance (Channel A & B)**

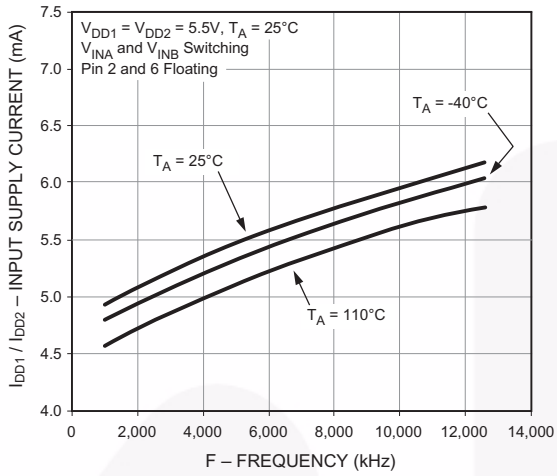


**Fig. 9 Typical Rise Time vs. Output Load Capacitance (Channel A & B)**

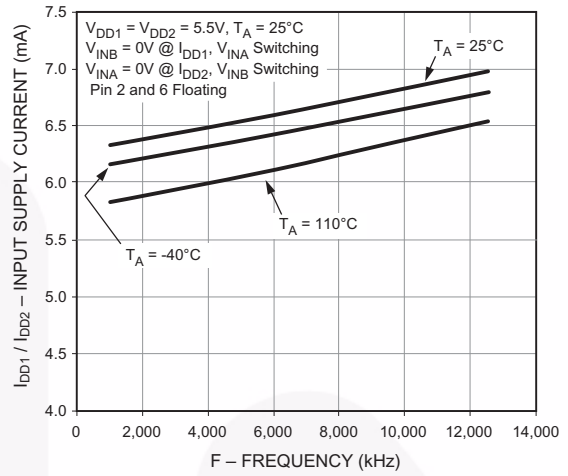


**Fig. 10 Typical Fall Time vs. Output Load Capacitance (Channel A & B)**

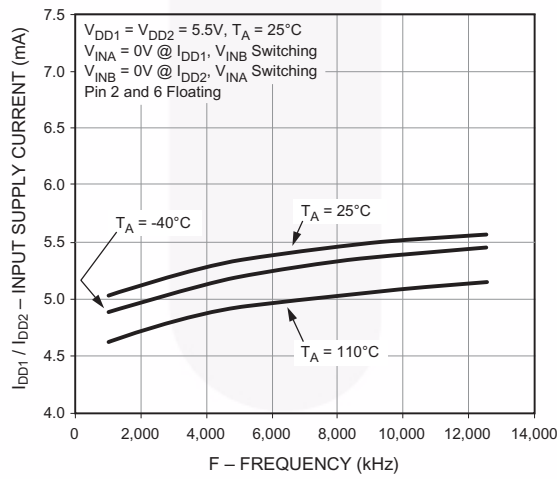
**Typical Performance Curves (Continued)**



**Fig. 11a Typical  $I_{DD1}/I_{DD2}$  Supply Current vs. Frequency**



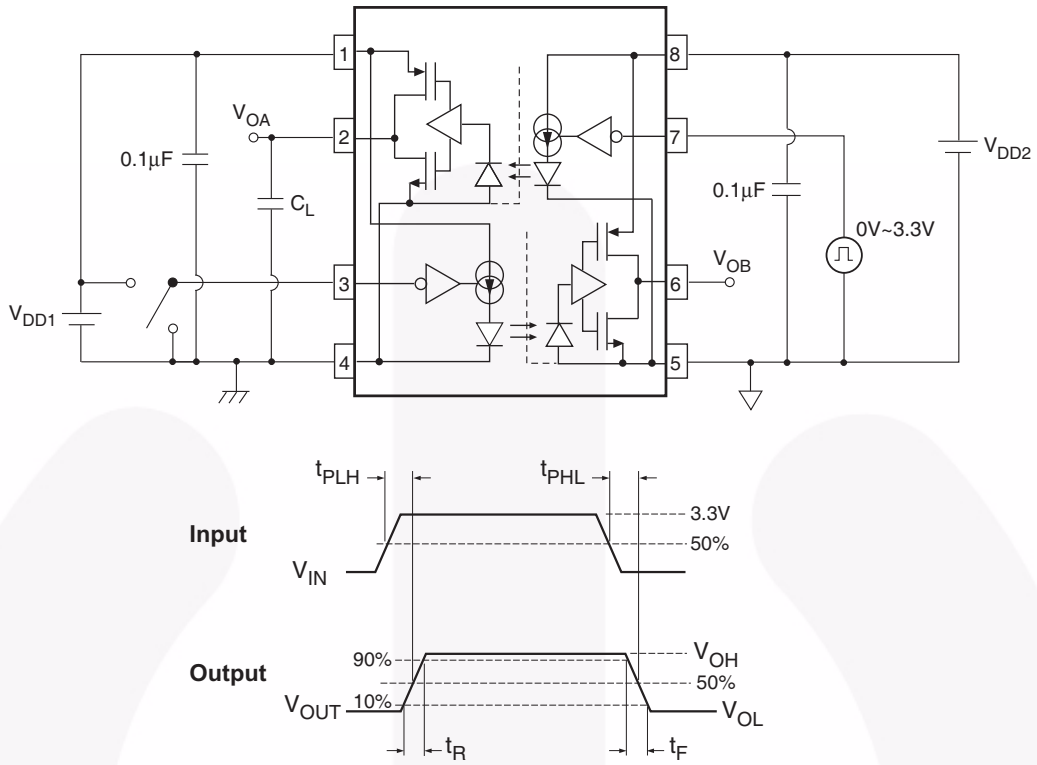
**Fig. 11b Typical  $I_{DD1}/I_{DD2}$  Supply Current vs. Frequency**



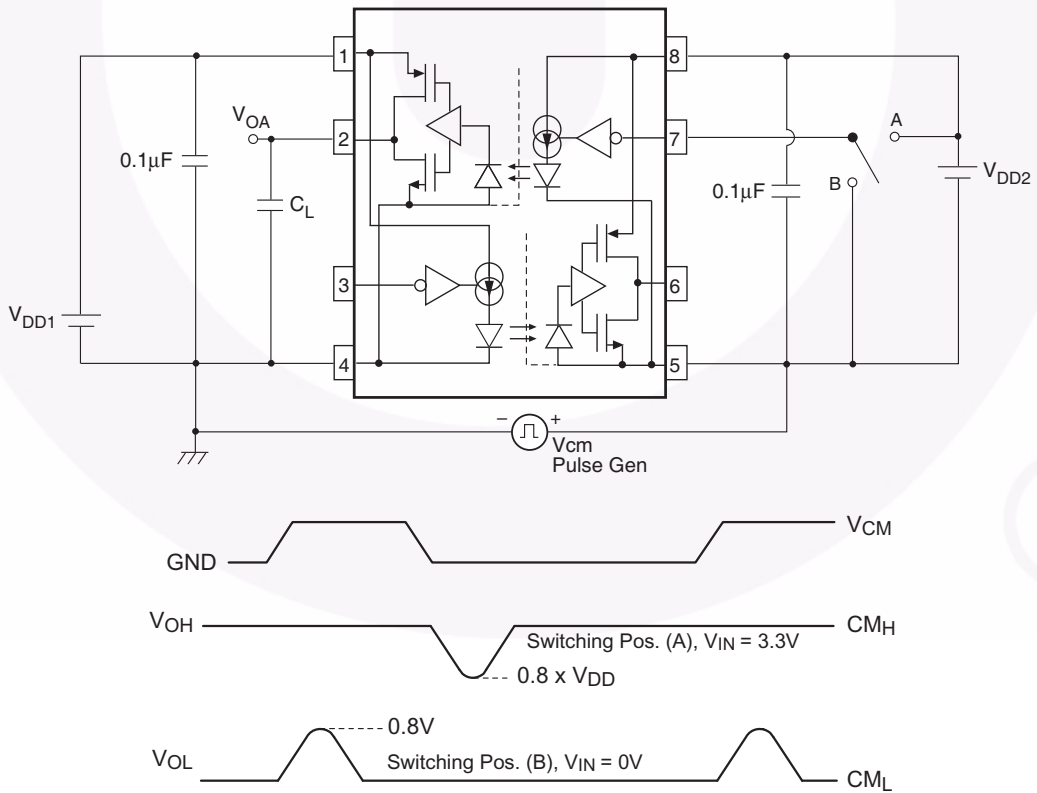
**Fig. 11c Typical  $I_{DD1}/I_{DD2}$  Supply Current vs. Frequency**



**Test Circuits**



**Figure 12. Test Circuit for Propagation Delay Time and Rise Time, Fall Time**



**Figure 13. Test Circuit for Instantaneous Common Mode Rejection Voltage**

Small Outline Package Dimensions

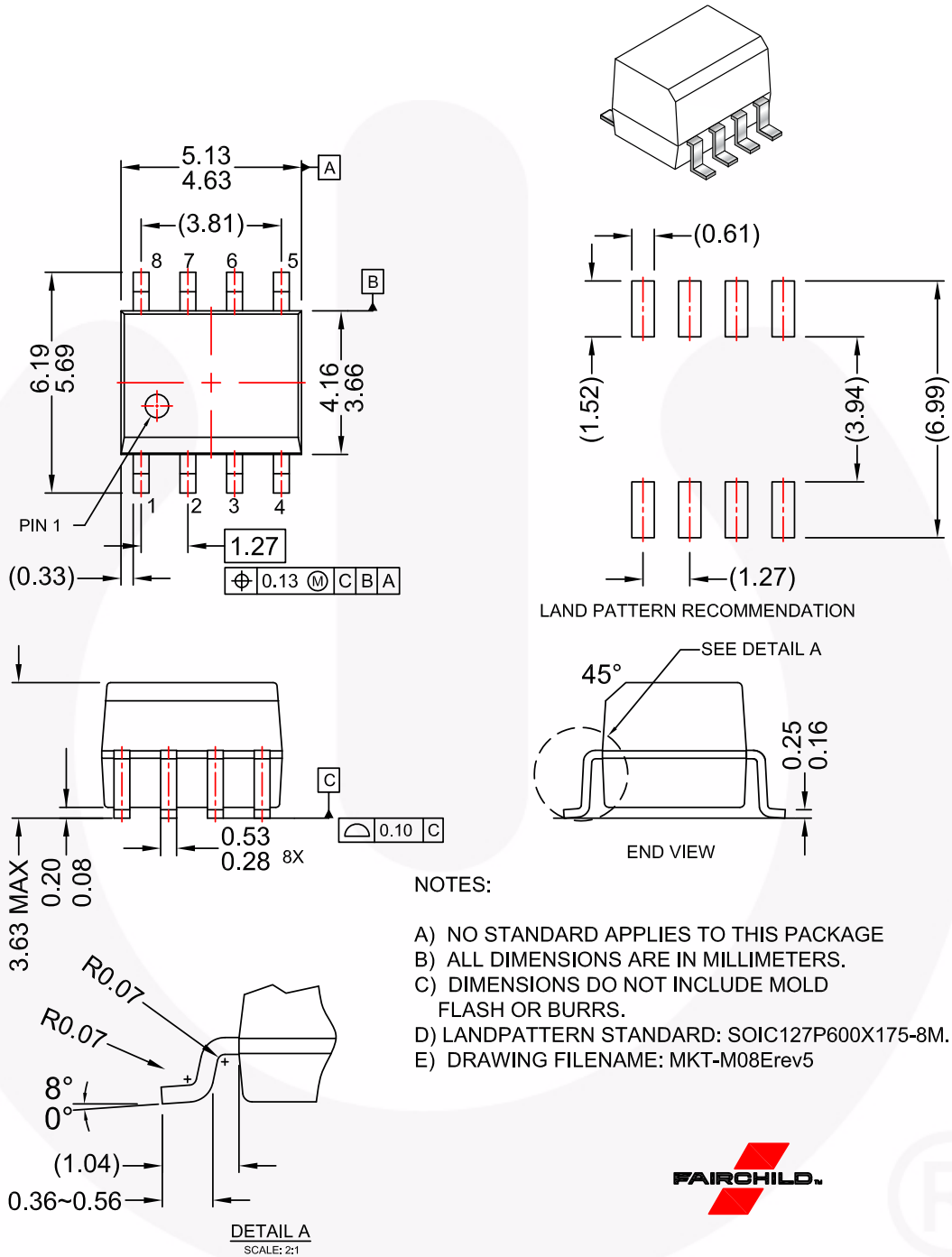
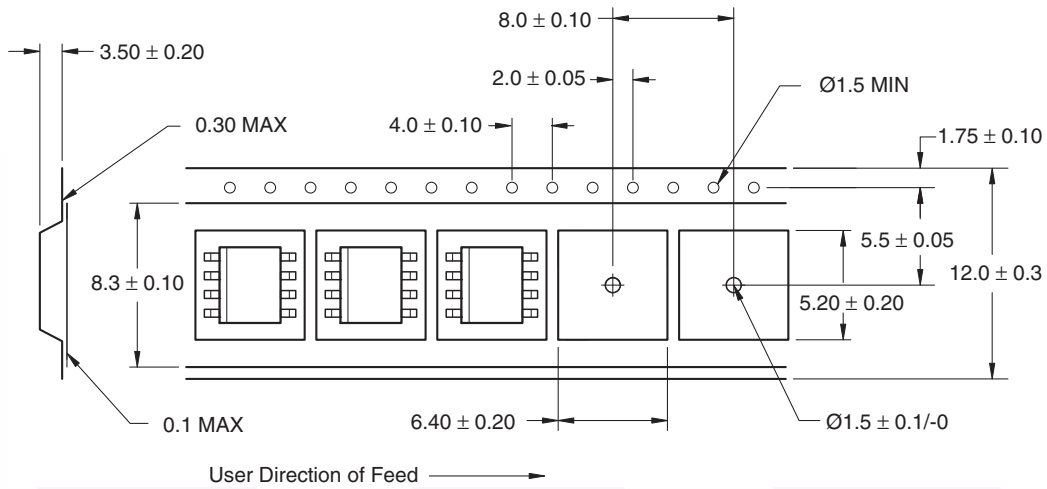


Figure 14. 8-Lead, SOIC, Small Outline 8-pin

### Carrier Tape Specification



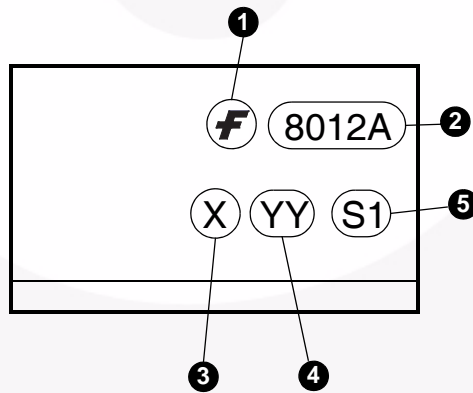
**Note:**  
All dimensions are in millimeters.

### Ordering Information

Option	Order Entry Identifier	Description
No Suffix	FOD8012A	Small outline 8-pin, shipped in tubes (50 units per tube)
R2	FOD8012AR2	Small outline 8-pin, tape and reel (2,500 units per reel)

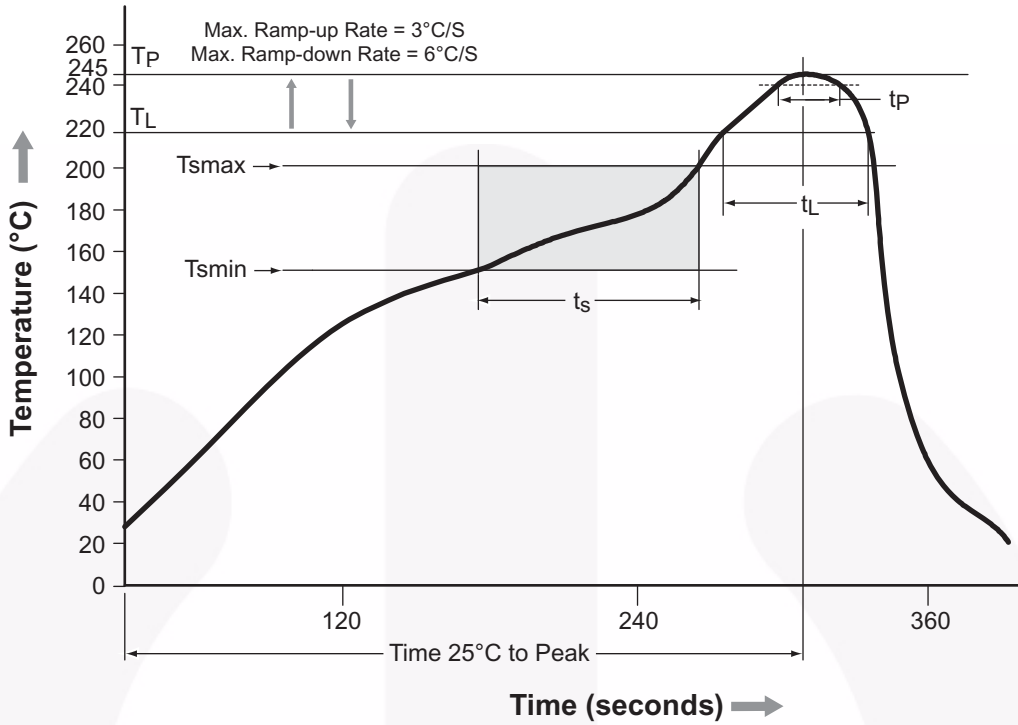
All packages are lead free per JEDEC: J-STD-020B standard.

### Marking Information



Definitions	
1	Fairchild logo
2	Device number
3	One digit year code, e.g., '8'
4	Two digit work week ranging from '01' to '53'
5	Assembly package code

### Reflow Profile








Profile Feature	Pb-Free Assembly Profile
Temperature Min. (T <sub>smin</sub> )	150°C
Temperature Max. (T <sub>smax</sub> )	200°C
Time (t <sub>s</sub> ) from (T <sub>smin</sub> to T <sub>smax</sub> )	60–120 seconds
Ramp-up Rate (t <sub>L</sub> to t <sub>p</sub> )	3°C/second max.
Liquidous Temperature (T <sub>L</sub> )	217°C
Time (t <sub>L</sub> ) Maintained Above (T <sub>L</sub> )	60–150 seconds
Peak Body Package Temperature	245°C +0°C / -5°C
Time (t <sub>p</sub> ) within 5°C of 245°C	30 seconds
Ramp-down Rate (T <sub>P</sub> to T <sub>L</sub> )	6°C/second max.
Time 25°C to Peak Temperature	8 minutes max.



### TRADEMARKS

The following includes registered and unregistered trademarks and service marks, owned by Fairchild Semiconductor and/or its global subsidiaries, and is not intended to be an exhaustive list of all such trademarks.

- |   |  |   |   |
|---|--|---|---|
| AccuPower™  | F-PFS™   | OPTOPLANAR®   |  |
| AttitudeEngine™   | FRFET®   |  | TinyBoost®  |
| Awinda®   | Global Power Resource <sup>SM</sup>            | Power Supply WebDesigner™   | TinyBuck®   |
| AX-CAP®*  | GreenBridge™                                   | PowerTrench®  | TinyCalc™   |
| BitSiC™   | Green FPS™                                     | PowerXS™  | TinyLogic®  |
| Build it Now™   | Green FPS™ e-Series™                           | Programmable Active Droop™  | TINYOPTO™   |
| CorePLUS™   | Gmax™  | QFET®   | TinyPower™  |
| CorePOWER™  | GTO™   | QS™   | TinyPWM™  |
| CROSSVOLT™  | IntelliMAX™                                    | Quiet Series™   | TinyWire™   |
| CTL™  | ISOPLANAR™                                     | RapidConfigure™   | TranSiC™  |
| Current Transfer Logic™   | Making Small Speakers Sound Louder and Better™ |  | TriFault Detect™  |
| DEUXPEED®   | MegaBuck™                                      | Saving our world, 1mW/W/kW at a time™   | TRUECURRENT®*   |
| Dual Cool™  | MICROCOUPLER™                                  | SignalWise™   | μSerDes™  |
| EcoSPARK®   | MicroFET™                                      | SmartMax™   |  |
| EfficientMax™   | MicroPak™                                      | SMART START™  | UHC®  |
| ESBC™   | MicroPak2™                                     | Solutions for Your Success™   | Ultra FRFET™  |
|  | MillerDrive™                                   | SPM®  | UniFET™   |
| Fairchild®  | MotionMax™                                     | STEALTH™  | VCX™  |
| Fairchild Semiconductor®  | MotionGrid®                                    | SuperFET®   | VisualMax™  |
| FACT Quiet Series™  | MTI®   | SuperSOT™-3   | VoltagePlus™  |
| FACT®   | MTx®   | SuperSOT™-6   | XS™   |
| FAST®   | MVN®   | SuperSOT™-8   | Xsens™  |
| FastvCore™  | mWSaver®                                       | SupreMOS®   | 仙童™   |
| FETBench™   | OptoHiT™                                       | SyncFET™  |   |
| FPS™  | OPTOLOGIC®                                     | Sync-Lock™  |   |

\* Trademarks of System General Corporation, used under license by Fairchild Semiconductor.

### DISCLAIMER

FAIRCHILD SEMICONDUCTOR RESERVES THE RIGHT TO MAKE CHANGES WITHOUT FURTHER NOTICE TO ANY PRODUCTS HEREIN TO IMPROVE RELIABILITY, FUNCTION, OR DESIGN. TO OBTAIN THE LATEST, MOST UP-TO-DATE DATASHEET AND PRODUCT INFORMATION, VISIT OUR WEBSITE AT [HTTP://WWW.FAIRCHILDSEMI.COM](http://www.fairchildsemi.com). FAIRCHILD DOES NOT ASSUME ANY LIABILITY ARISING OUT OF THE APPLICATION OR USE OF ANY PRODUCT OR CIRCUIT DESCRIBED HEREIN; NEITHER DOES IT CONVEY ANY LICENSE UNDER ITS PATENT RIGHTS, NOR THE RIGHTS OF OTHERS. THESE SPECIFICATIONS DO NOT EXPAND THE TERMS OF FAIRCHILD'S WORLDWIDE TERMS AND CONDITIONS, SPECIFICALLY THE WARRANTY THEREIN, WHICH COVERS THESE PRODUCTS.

### AUTHORIZED USE

Unless otherwise specified in this data sheet, this product is a standard commercial product and is not intended for use in applications that require extraordinary levels of quality and reliability. This product may not be used in the following applications, unless specifically approved in writing by a Fairchild officer: (1) automotive or other transportation, (2) military/aerospace, (3) any safety critical application – including life critical medical equipment – where the failure of the Fairchild product reasonably would be expected to result in personal injury, death or property damage. Customer's use of this product is subject to agreement of this Authorized Use policy. In the event of an unauthorized use of Fairchild's product, Fairchild accepts no liability in the event of product failure. In other respects, this product shall be subject to Fairchild's Worldwide Terms and Conditions of Sale, unless a separate agreement has been signed by both Parties.

### ANTI-COUNTERFEITING POLICY

Fairchild Semiconductor Corporation's Anti-Counterfeiting Policy. Fairchild's Anti-Counterfeiting Policy is also stated on our external website, [www.fairchildsemi.com](http://www.fairchildsemi.com), under Terms of Use

Counterfeiting of semiconductor parts is a growing problem in the industry. All manufacturers of semiconductor products are experiencing counterfeiting of their parts. Customers who inadvertently purchase counterfeit parts experience many problems such as loss of brand reputation, substandard performance, failed applications, and increased cost of production and manufacturing delays. Fairchild is taking strong measures to protect ourselves and our customers from the proliferation of counterfeit parts. Fairchild strongly encourages customers to purchase Fairchild parts either directly from Fairchild or from Authorized Fairchild Distributors who are listed by country on our web page cited above. Products customers buy either from Fairchild directly or from Authorized Fairchild Distributors are genuine parts, have full traceability, meet Fairchild's quality standards for handling and storage and provide access to Fairchild's full range of up-to-date technical and product information. Fairchild and our Authorized Distributors will stand behind all warranties and will appropriately address any warranty issues that may arise. Fairchild will not provide any warranty coverage or other assistance for parts bought from Unauthorized Sources. Fairchild is committed to combat this global problem and encourage our customers to do their part in stopping this practice by buying direct or from authorized distributors.

### PRODUCT STATUS DEFINITIONS

#### Definition of Terms

Datasheet Identification	Product Status	Definition
Advance Information	Formative / In Design	Datasheet contains the design specifications for product development. Specifications may change in any manner without notice.
Preliminary	First Production	Datasheet contains preliminary data; supplementary data will be published at a later date. Fairchild Semiconductor reserves the right to make changes at any time without notice to improve design.
No Identification Needed	Full Production	Datasheet contains final specifications. Fairchild Semiconductor reserves the right to make changes at any time without notice to improve the design.
Obsolete	Not In Production	Datasheet contains specifications on a product that is discontinued by Fairchild Semiconductor. The datasheet is for reference information only.

Rev. I75

ON Semiconductor and  are trademarks of Semiconductor Components Industries, LLC dba ON Semiconductor or its subsidiaries in the United States and/or other countries. ON Semiconductor owns the rights to a number of patents, trademarks, copyrights, trade secrets, and other intellectual property. A listing of ON Semiconductor's product/patent coverage may be accessed at [www.onsemi.com/site/pdf/Patent-Marking.pdf](http://www.onsemi.com/site/pdf/Patent-Marking.pdf). ON Semiconductor reserves the right to make changes without further notice to any products herein. ON Semiconductor makes no warranty, representation or guarantee regarding the suitability of its products for any particular purpose, nor does ON Semiconductor assume any liability arising out of the application or use of any product or circuit, and specifically disclaims any and all liability, including without limitation special, consequential or incidental damages. Buyer is responsible for its products and applications using ON Semiconductor products, including compliance with all laws, regulations and safety requirements or standards, regardless of any support or applications information provided by ON Semiconductor. "Typical" parameters which may be provided in ON Semiconductor data sheets and/or specifications can and do vary in different applications and actual performance may vary over time. All operating parameters, including "Typicals" must be validated for each customer application by customer's technical experts. ON Semiconductor does not convey any license under its patent rights nor the rights of others. ON Semiconductor products are not designed, intended, or authorized for use as a critical component in life support systems or any FDA Class 3 medical devices or medical devices with a same or similar classification in a foreign jurisdiction or any devices intended for implantation in the human body. Should Buyer purchase or use ON Semiconductor products for any such unintended or unauthorized application, Buyer shall indemnify and hold ON Semiconductor and its officers, employees, subsidiaries, affiliates, and distributors harmless against all claims, costs, damages, and expenses, and reasonable attorney fees arising out of, directly or indirectly, any claim of personal injury or death associated with such unintended or unauthorized use, even if such claim alleges that ON Semiconductor was negligent regarding the design or manufacture of the part. ON Semiconductor is an Equal Opportunity/Affirmative Action Employer. This literature is subject to all applicable copyright laws and is not for resale in any manner.

## PUBLICATION ORDERING INFORMATION

### LITERATURE FULFILLMENT:

Literature Distribution Center for ON Semiconductor  
19521 E. 32nd Pkwy, Aurora, Colorado 80011 USA  
**Phone:** 303-675-2175 or 800-344-3860 Toll Free USA/Canada  
**Fax:** 303-675-2176 or 800-344-3867 Toll Free USA/Canada  
**Email:** [orderlit@onsemi.com](mailto:orderlit@onsemi.com)

**N. American Technical Support:** 800-282-9855 Toll Free  
USA/Canada  
**Europe, Middle East and Africa Technical Support:**  
Phone: 421 33 790 2910  
**Japan Customer Focus Center**  
Phone: 81-3-5817-1050

**ON Semiconductor Website:** [www.onsemi.com](http://www.onsemi.com)  
**Order Literature:** <http://www.onsemi.com/orderlit>  
For additional information, please contact your local  
Sales Representative