

PRODUCT NUMBER

51720C- ABBCCDDEF --
NOTE ①

SEE DETAIL A SEE DETAIL B

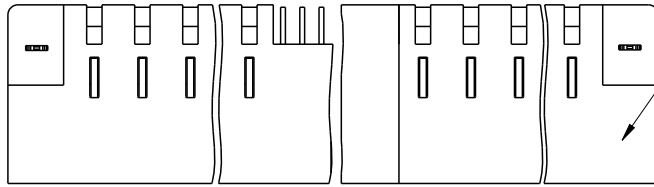
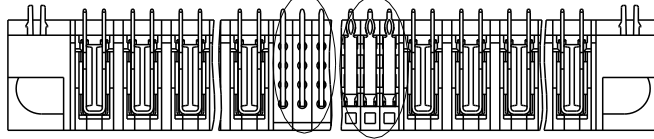

SEE NOTE 9

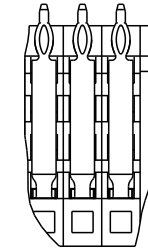
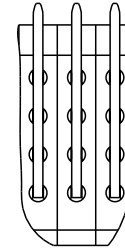

R DETAIL A
SCALE 2:1
FOR SIGNAL SOLDER TO BOARD ONLY

R DETAIL B
SCALE 2:1
FOR SIGNAL PRESS FIT ONLY

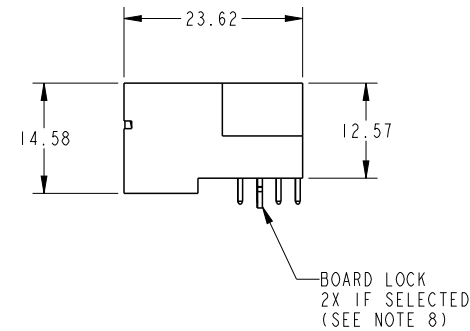
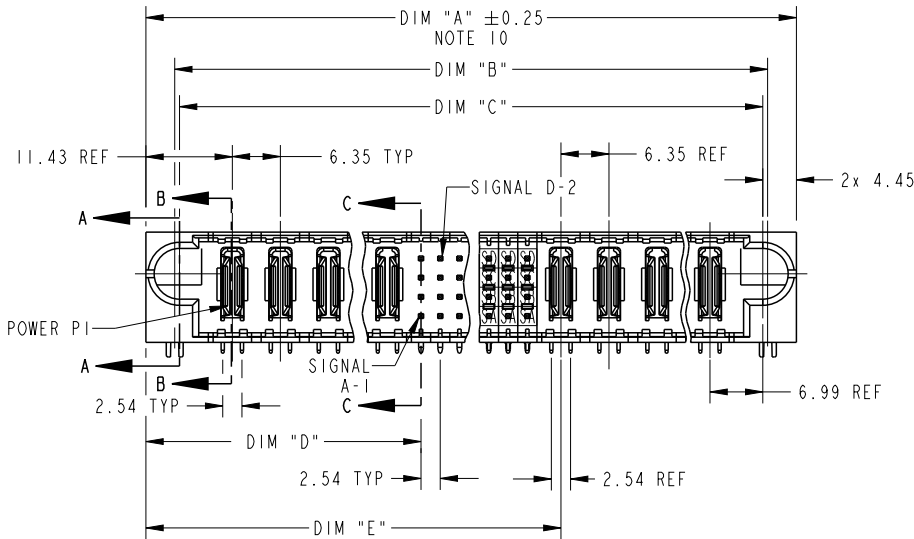

Copyright FCI.

spec ref	*	dr	w cadmin	2006/11/08	projection	MM	size	A4	scale	1:1		
tolerance std	TOLERANCES UNLESS OTHERWISE SPECIFIED	eng	Jackie Huang	2013/06/27			ecn no	ELX-DG-13802-1				
		chr	-	-				rel level	Released			
surface		appr	Pei-Ming Zheng	2013/06/30					product family	PwrBlade		
	linear	0.X	±0.50		title			RIGHT ANGLE HEADER w/GUIDE	dwg no	51720	rev	R
		0.XX	±0.25		POWER / SIGNAL / POWER							
		0.XXX	±0.10		cat. no.	51720	Product - Customer Drw	sheet 1 of 3				
	angular	0°	±2°	www.fci.com								

PRODUCT NUMBER
51720- ABBCCCDDEF-- NOTE ①

DIM	LENGTH FORMULAS (SEE NOTE 10)
DIM "A"	$6.35 \times BB + 2.54 \times (CCC/4) + 6.35 \times DD + 16.51$ (NOTE 10)
DIM "B"	$6.35 \times BB + 2.54 \times (CCC/4) + 6.35 \times DD + 8.89$
DIM "C"	$6.35 \times BB + 2.54 \times (CCC/4) + 6.35 \times DD + 7.62$
DIM "D"	$6.35 \times BB + 9.53$
DIM "E"	$6.35 \times BB + 2.54 \times (CCC/4) + 11.43$
DIM "F"	$6.35 \times BB + 2.54 \times (CCC/4) + 6.35 \times DD + 17.27$
DIM "G"	$6.35 \times BB + 5.72$
DIM "H"	$6.35 \times BB + 2.54 \times (CCC/4) + 6.35$

CONNECTOR NOTES

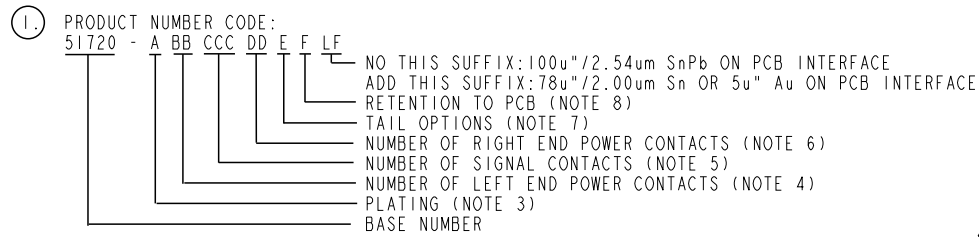

- ②. HOUSING MATERIAL: GLASS FILLED V-O HIGH TEMP THERMO PLASTIC.
SIGNAL CONTACT MATERIAL: COPPER ALLOY
POWER CONTACT MATERIAL: COPPER ALLOY
- ③. PLATING OPTION:
1: SEE ITEM PRINT 10064183 FOR PLATING SPEC OF 51720-ABBCCDDEF; 51720-ABBCCDDEFLF
- ④. LEFT END POWER CONTACTS, 01 TO 20 AVAILABLE.
MAXIMUM OF 20 POWER CONTACTS PER CONNECTOR.
- ⑤. SIGNAL CONTACTS, 004 TO 148 AVAILABLE.
- ⑥. RIGHT END POWER CONTACTS, 01 TO 20 AVAILABLE.
MAXIMUM OF 20 POWER CONTACTS PER CONNECTOR.
- ⑦. TAIL OPTIONS:
A = 3.43 SOLDER TO BOARD
△C = 3.43 PRESS FIT

- ⑧. RETENTION TO PCB OPTIONS:
A = BOARD LOCK (2.49 +0.05, -0.03 THRU HOLE IN PCB).
MOUNTING FOOT THICKNESS: 5.59
B = 3.81 THRU HOLE (REQUIRES 4.01±08 THRU HOLE IN PCB).
MOUNTING FOOT THICKNESS: 4.06
- 9. MANUFACTURE'S NAME, P/N, AND DATE CODE TO APPEAR ON THIS SURFACE.
- 10. THE MAXIMUM OVERALL LENGTH (DIM A) OF A PART IS 203.2
- ①①. PRODUCT SPECIFICATION GS-12-149
APPLICATION SPECIFICATION BUS-20-067
- 12. REFERENCE 51697 FOR SPECIALS WORKSHEET.

- PCB NOTES:
- 13. ALL DIMENSIONS ARE BASIC UNLESS OTHERWISE SPECIFIED.
 - 14. ALL THROUGH HOLES ARE LOCATED WITH A TRUE POSITION OF 0.10
 - 15. ALL HOLE DIAMETERS ARE FINISHED HOLE SIZE.
 - ①⑥. Ø1.151 ±0.02 DRILLED HOLES PLATED WITH 0.007 MIN SnPb or Sn OVER 0.03 TO 0.08 PLATING TO ACHIEVE A 1.02±0.07 HOLE.
 - 17. A △ SYMBOL WILL BE NEXT TO ANY DIMENSION, VIEW, OR NOTE WHICH HAS BEEN MODIFIED WITH THE CURRENT DRAWING REVISION.
 - ①⑧. CONNECTOR KEEP OUT ZONE.



Copyright FCI.

dr	w wadmin	2006/11/08	projection 	MM 	size	A4	scale	1:1
eng	Jackie Huang	2013/06/27			ecn no	ELX-DG-13802-1		
chr	-	-			rel level	Released		
appr	Pei-Ming Zheng	2013/06/30	product family	PwrBlade		rev	R	
www.fci.com		cat. no.	51720	Product - Customer Drw	sheet 2 of 3			

PRODUCT NUMBER
51720C - ABBCCDDEF --
NOTE ①

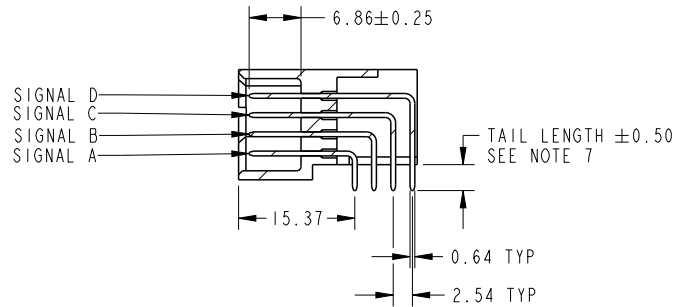

SECTION C-C
SCALE 1:1
FOR SIGNAL SOLDER TO BOARD ONLY

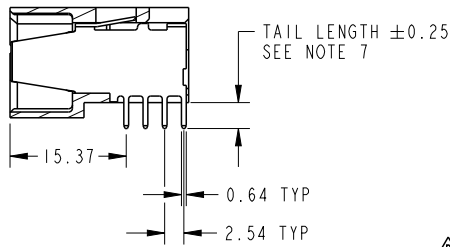
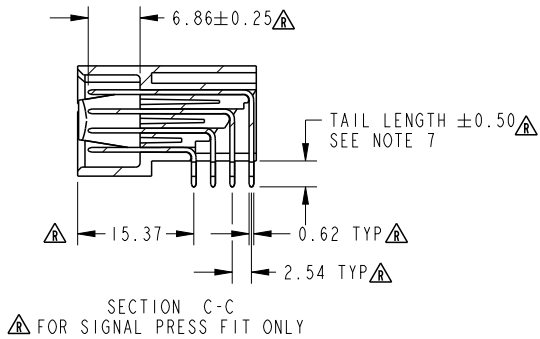

SECTION B-B
SCALE 1:1

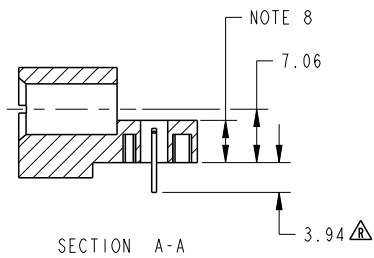

SECTION A-A

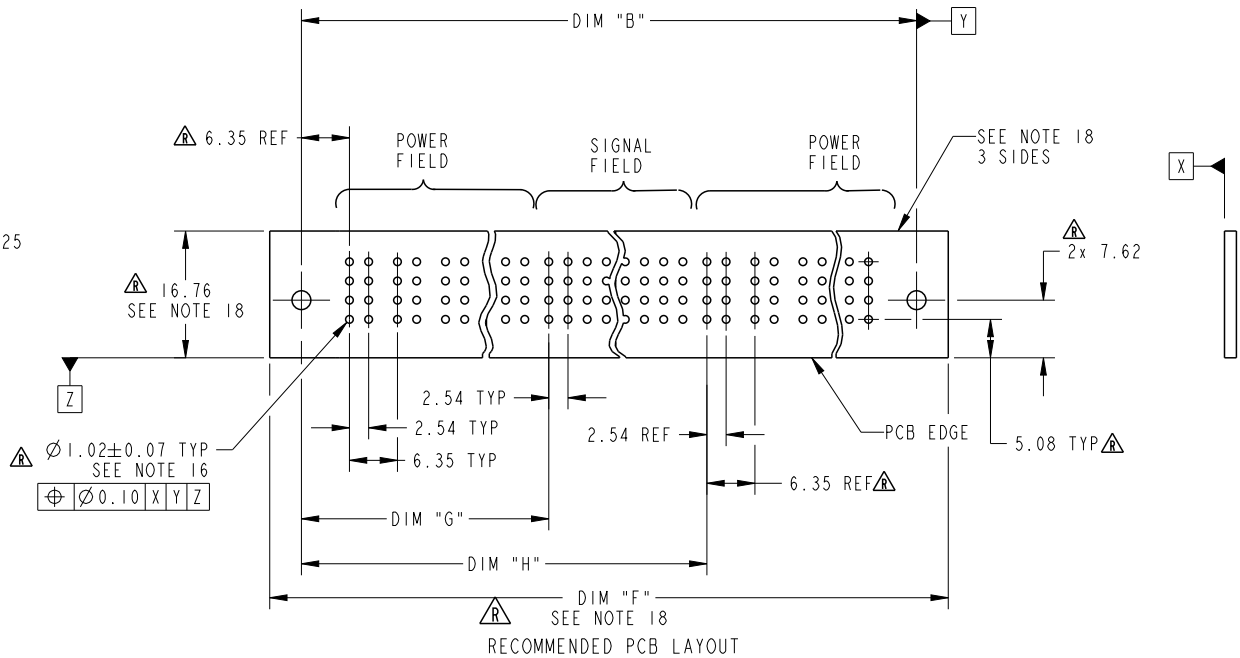

DIM "F"
SEE NOTE 18
RECOMMENDED PCB LAYOUT

dr	w wadmin	2006/11/08	projection 	MM 	size	A4	scale	1:1
eng	Jackie Huang	2013/06/27			ecn no	ELX-DG-13802-1		
chr	-	-			rel level	Released		
appr	Pei-Ming Zheng	2013/06/30	product family	PwrBlade		rev	R	
www.fci.com		cat. no.	51720	Product - Customer Drw	sheet 3 of 3			



Copyright FCI.