



Part No: GF0571

Date: 9/20/2006

Unit: mm

Description: speaker

Page No: 1 of 2



Specifications

Nominal Size	57 mm (2.25 in)	(See attached drawing)
Impedance	8 Ohm \pm 15%	at 800 Hz 1 V
Resonant frequency	380 Hz \pm 76 Hz	at 1 V
Sound pressure level	86 dB/w \pm 3 dB	0.25 w 50 cm ave. at 1.0K, 1.4K, 1.7K, 2.0K Hz
Response	Fo Hz ~ 8.1 KHz max 10 dB	
Input power	Nominal 0.25 W	Handling capacity 0.5 W
Operation	must be normal at program source 0.25 W	
Buzz, rattle, etc.	must be normal at sine wave 1.41 V	
Magnet	Size: 32 x 18 x 6 mm	
Load test	White noise 0.25 W for	5 hours
Heat test	70 \pm 2° C	20-50% R.H. 5 hours
Humidity test	40 \pm 2° C	90-95% R.H. 5 hours

Frequency Response Curve

Potentiometer range	50 dB
Rectifier	RMS
Lower limit frequency	20 Hz
Wr. speed	100 mm/sec

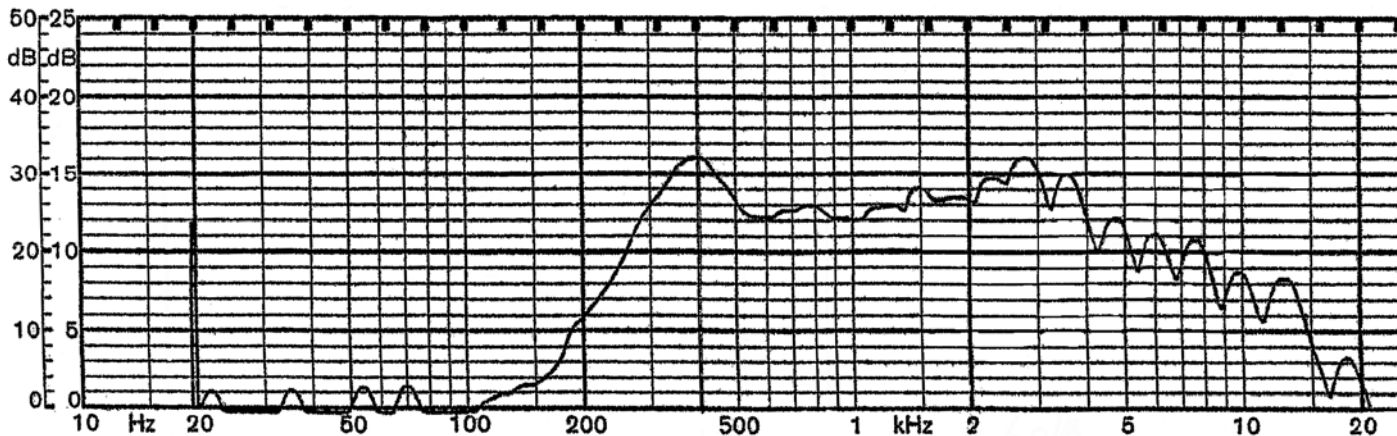

Zero level 60 dB

REV.	DESCRIPTION	DATE
A	NEW DRAWING	8/8/2006

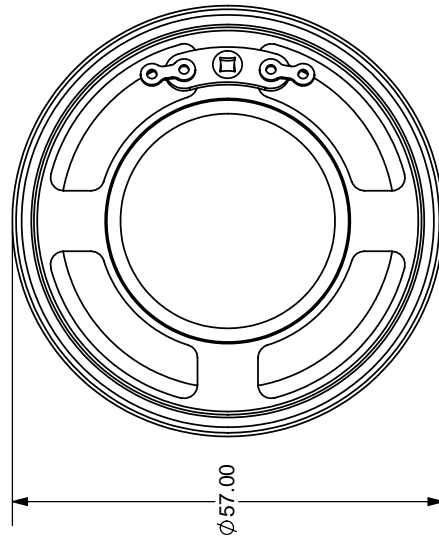
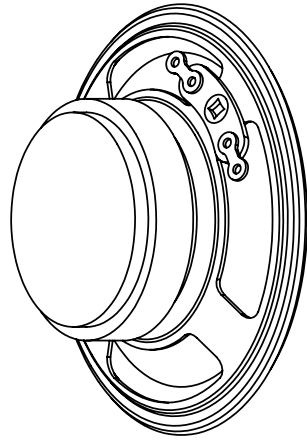
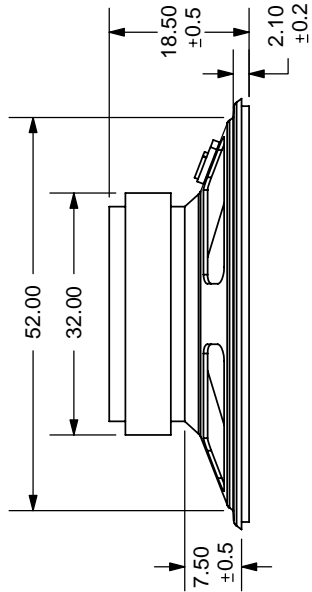

TOLERANCE:
±0.3mm UNLESS OTHERWISE
SPECIFIED



CUI INC

20050 SW 112th Ave.
Tualatin, OR 97062
Phone: 503-643-4899
800-275-4899
Fax: 503-372-1266
Website: www.cui.com

TITLE: Round frame paper cone - ferrite magnet	REV: A
PART NO: GF0571	UNITS: MM [INCHES]
DRAWN BY: ZRJ	APPROVED BY:
	SCALE: 1:1