

AO7600

Complementary Enhancement Mode Field Effect Transistor

General Description

The AO7600 uses advanced trench technology MOSFETs to provide excellent $R_{DS(ON)}$ and low gate charge. The complementary MOSFETs may be used to form a level shifted high side switch, an inverter, and for a host of other applications. Both devices are ESD protected.

Features

n-channel	p-channel
$V_{DS} (V) = 20V$	-20V
$I_D = 0.9A (V_{GS}=4.5V)$	-0.6A ($V_{GS}=-4.5V$)
$R_{DS(ON)} < 300m\Omega (V_{GS}=4.5V)$	$R_{DS(ON)} < 550m\Omega (V_{GS}=-4.5V)$
$< 350m\Omega (V_{GS}=2.5V)$	$< 700m\Omega (V_{GS}=-2.5V)$
$< 450m\Omega (V_{GS}=1.8V)$	$< 950m\Omega (V_{GS}=-1.8V)$

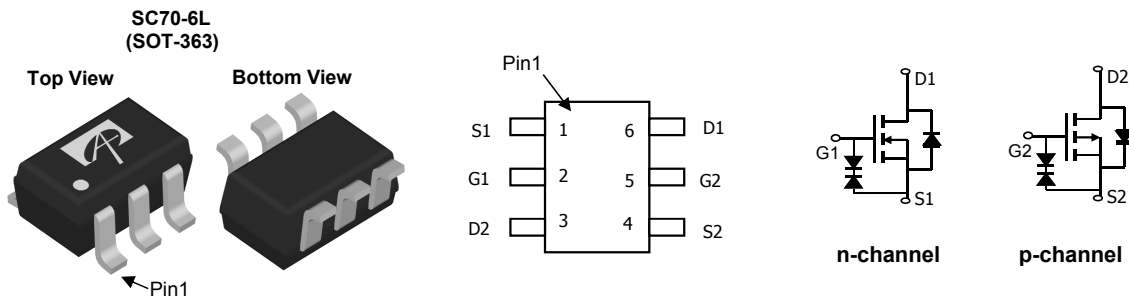

Absolute Maximum Ratings $T_A=25^\circ C$ unless otherwise noted

Parameter	Symbol	Max n-channel	Max p-channel	Units
Drain-Source Voltage	V_{DS}	20	-20	V
Gate-Source Voltage	V_{GS}	± 8	± 8	V
Continuous Drain Current ^A	I_D	$T_A=25^\circ C$	0.9	-0.6
		$T_A=70^\circ C$	0.7	-0.48
Pulsed Drain Current ^B	I_{DM}	5	-3	A
Power Dissipation	P_D	$T_A=25^\circ C$	0.3	0.3
		$T_A=70^\circ C$	0.19	0.19
Junction and Storage Temperature Range	T_J, T_{STG}	-55 to 150	-55 to 150	$^\circ C$

Thermal Characteristics: n-channel and p-channel

Parameter	Symbol	Device	Typ	Max	Units
Maximum Junction-to-Ambient ^A	$R_{\theta JA}$	n-ch	360	415	$^\circ C/W$
Maximum Junction-to-Ambient ^A		n-ch	400	460	$^\circ C/W$
Maximum Junction-to-Lead ^C	$R_{\theta JL}$	n-ch	300	350	$^\circ C/W$
Maximum Junction-to-Ambient ^A	$R_{\theta JA}$	p-ch	360	415	$^\circ C/W$
Maximum Junction-to-Ambient ^A		p-ch	400	460	$^\circ C/W$
Maximum Junction-to-Lead ^C	$R_{\theta JL}$	p-ch	300	350	$^\circ C/W$

N-Channel: Electrical Characteristics (T_J=25°C unless otherwise noted)

Symbol	Parameter	Conditions	Min	Typ	Max	Units
STATIC PARAMETERS						
BV _{DSS}	Drain-Source Breakdown Voltage	I _D =250μA, V _{GS} =0V	20			V
I _{DSS}	Zero Gate Voltage Drain Current	V _{DS} =16V, V _{GS} =0V T _J =55°C			1 5	μA
I _{GSS}	Gate-Body leakage current	V _{DS} =0V, V _{GS} =±8V			25	μA
V _{GS(th)}	Gate Threshold Voltage	V _{DS} =V _{GS} , I _D =250μA	0.5	0.75	0.9	V
I _{D(ON)}	On state drain current	V _{GS} =4.5V, V _{DS} =5V	5			A
R _{DS(ON)}	Static Drain-Source On-Resistance	V _{GS} =4.5V, I _D =0.9A T _J =125°C		181 253	300 330	mΩ
		V _{GS} =2.5V, I _D =0.75A		237	350	mΩ
		V _{GS} =1.8V, I _D =0.7A		317	450	mΩ
g _{FS}	Forward Transconductance	V _{DS} =5V, I _D =0.8A		2.6		S
V _{SD}	Diode Forward Voltage	I _S =0.5A, V _{GS} =0V		0.69	1	V
I _S	Maximum Body-Diode Continuous Current				0.4	A
DYNAMIC PARAMETERS						
C _{iss}	Input Capacitance	V _{GS} =0V, V _{DS} =10V, f=1MHz		101	120	pF
C _{oss}	Output Capacitance			17		pF
C _{rss}	Reverse Transfer Capacitance			14		pF
R _g	Gate resistance	V _{GS} =0V, V _{DS} =0V, f=1MHz		3	4	Ω
SWITCHING PARAMETERS						
Q _g	Total Gate Charge	V _{GS} =4.5V, V _{DS} =10V, I _D =0.8A		1.57	1.9	nC
Q _{gs}	Gate Source Charge			0.13		nC
Q _{gd}	Gate Drain Charge			0.36		nC
t _{D(on)}	Turn-On DelayTime	V _{GS} =5V, V _{DS} =10V, R _L =12.5Ω, R _{GEN} =6Ω		3.2		ns
t _r	Turn-On Rise Time			4		ns
t _{D(off)}	Turn-Off DelayTime			15.5		ns
t _f	Turn-Off Fall Time			2.4		ns
t _{rr}	Body Diode Reverse Recovery Time	I _F =0.8A, di/dt=100A/μs		6.7	8.1	ns
Q _{rr}	Body Diode Reverse Recovery Charge	I _F =0.8A, di/dt=100A/μs		1.6		nC

A: The value of R_{θJA} is measured with the device mounted on 1in² FR-4 board with 2oz. Copper, in a still air environment with T_A=25° C. The value in any given application depends on the user's specific board design. The current rating is based on the t ≤ 10s thermal resistance rating.

B: Repetitive rating, pulse width limited by junction temperature.

C: The R_{θJA} is the sum of the thermal impedance from junction to lead R_{θJL} and lead to ambient.

D: The static characteristics in Figures 1 to 6 are obtained using <300 μs pulses, duty cycle 0.5% max.

E: These tests are performed with the device mounted on 1 in² FR-4 board with 2oz. Copper, in a still air environment with T_A=25° C. The SOA curve provides a single pulse rating.

THIS PRODUCT HAS BEEN DESIGNED AND QUALIFIED FOR THE CONSUMER MARKET. APPLICATIONS OR USES AS CRITICAL COMPONENTS IN LIFE SUPPORT DEVICES OR SYSTEMS ARE NOT AUTHORIZED. AOS DOES NOT ASSUME ANY LIABILITY ARISING OUT OF SUCH APPLICATIONS OR USES OF ITS PRODUCTS. AOS RESERVES THE RIGHT TO IMPROVE PRODUCT DESIGN, FUNCTIONS AND RELIABILITY WITHOUT NOTICE.

N-Channel: TYPICAL ELECTRICAL AND THERMAL CHARACTERISTICS

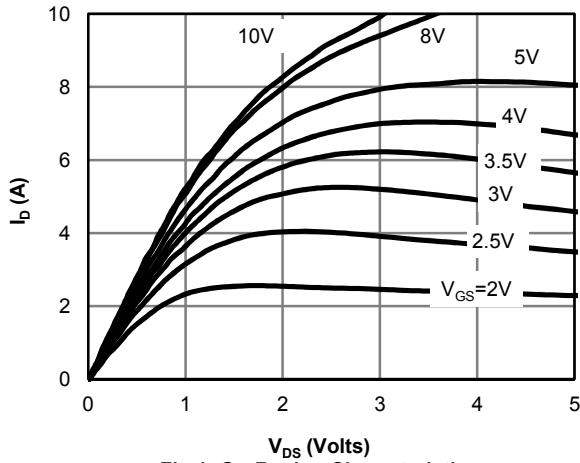

Fig 1: On-Region Characteristics

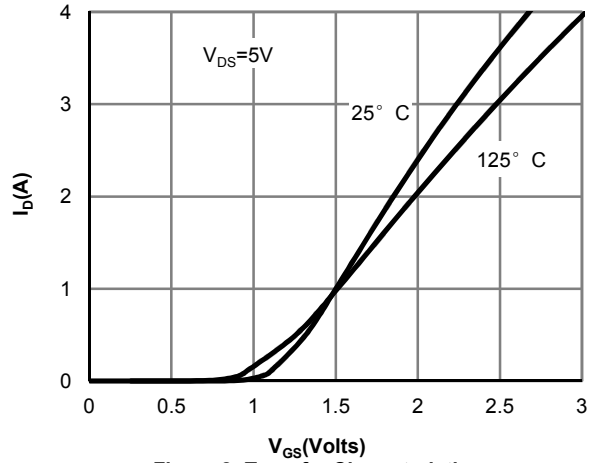

Figure 2: Transfer Characteristics

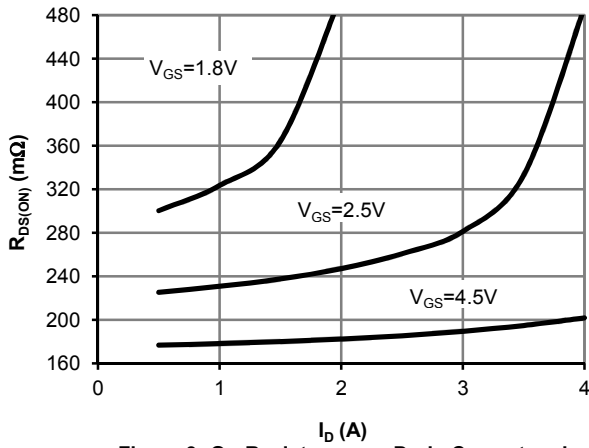

Figure 3: On-Resistance vs. Drain Current and Gate Voltage

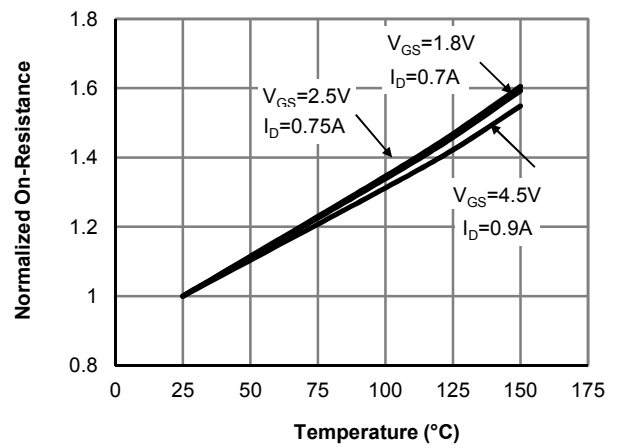

Figure 4: On-Resistance vs. Junction Temperature

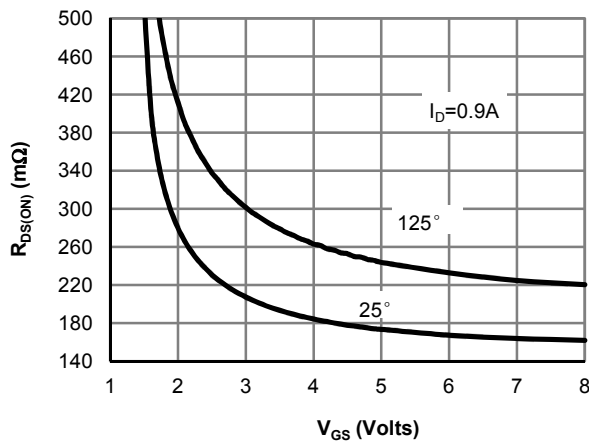

Figure 5: On-Resistance vs. Gate-Source Voltage

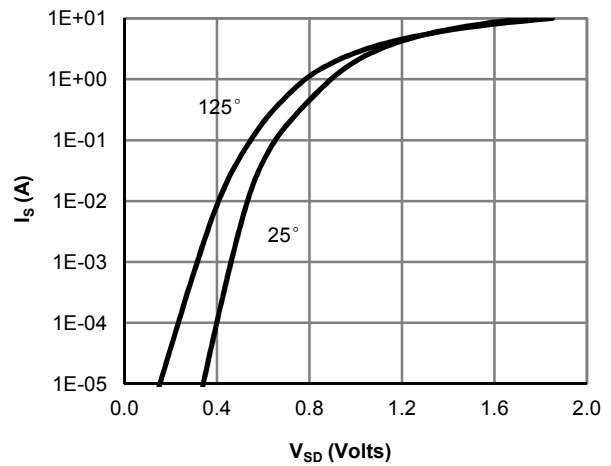

Figure 6: Body-Diode Characteristics

N-Channel: TYPICAL ELECTRICAL AND THERMAL CHARACTERISTICS

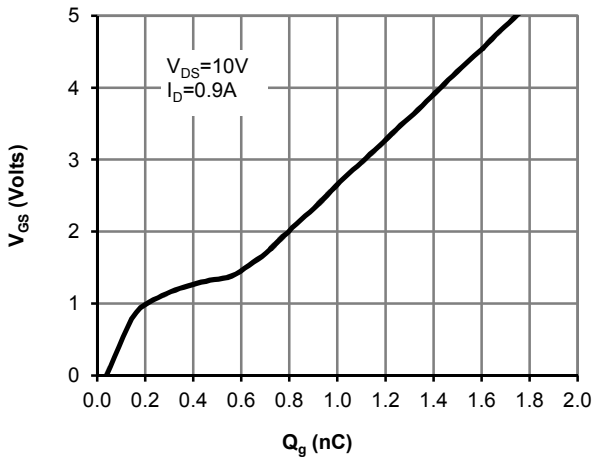

Figure 7: Gate-Charge Characteristics

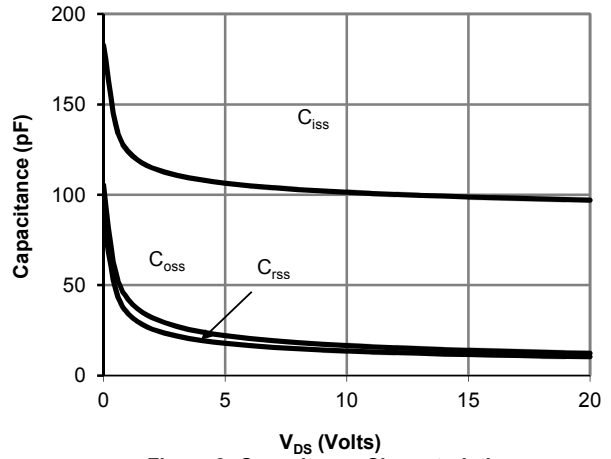

Figure 8: Capacitance Characteristics

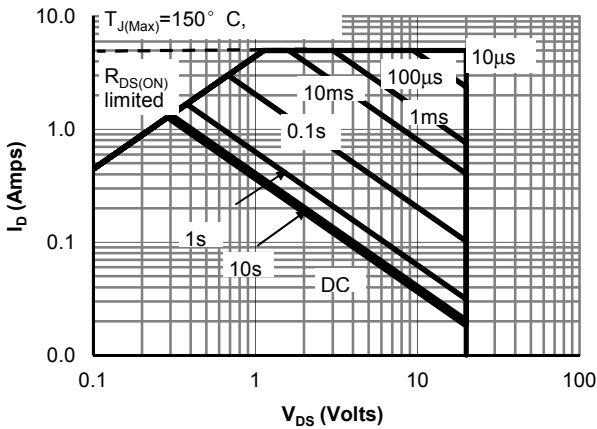

Figure 9: Maximum Forward Biased Safe Operating Area (Note E)

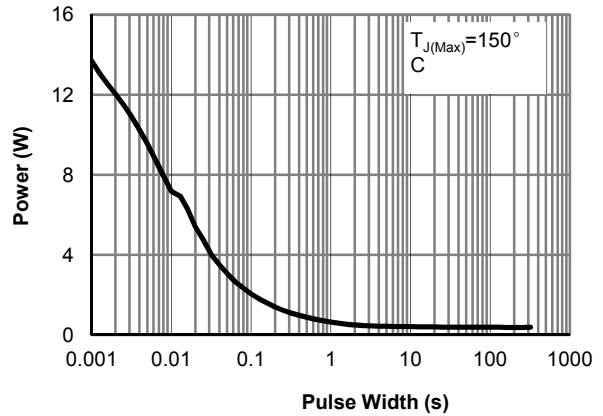

Figure 10: Single Pulse Power Rating Junction-to-Ambient (Note E)

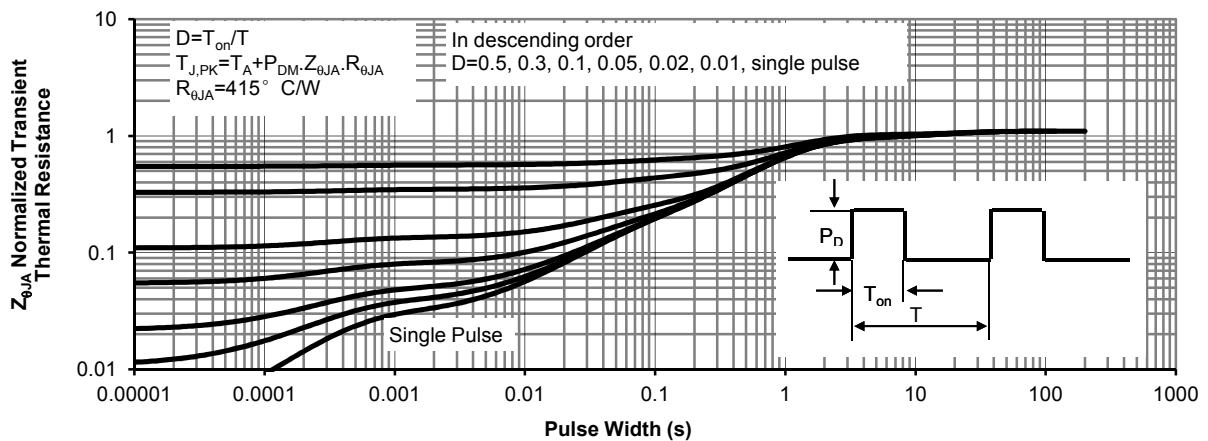

Figure 11: Normalized Maximum Transient Thermal Impedance

P-Channel Electrical Characteristics (T_J=25°C unless otherwise noted)

Symbol	Parameter	Conditions	Min	Typ	Max	Units
STATIC PARAMETERS						
BV _{DSS}	Drain-Source Breakdown Voltage	I _D =-250μA, V _{GS} =0V	-20			V
I _{DSS}	Zero Gate Voltage Drain Current	V _{DS} =-16V, V _{GS} =0V T _J =55°C			-1 -5	μA
I _{GSS}	Gate-Body leakage current	V _{DS} =0V, V _{GS} =±8V			±10	μA
V _{GS(th)}	Gate Threshold Voltage	V _{DS} =V _{GS} , I _D =-250μA	-0.5	-0.6	-0.9	V
I _{D(ON)}	On state drain current	V _{GS} =-4.5V, V _{DS} =-5V	-3			A
R _{DS(ON)}	Static Drain-Source On-Resistance	V _{GS} =-4.5V, I _D =-0.6A T _J =125°C		415 542	550 700	mΩ
		V _{GS} =-2.5V, I _D =-0.5A		590	700	mΩ
		V _{GS} =-1.8V, I _D =-0.4A		700	950	mΩ
g _{FS}	Forward Transconductance	V _{DS} =-5V, I _D =-0.6A		1.7		S
V _{SD}	Diode Forward Voltage	I _S =-0.5A, V _{GS} =0V		-0.86	-1	V
I _S	Maximum Body-Diode Continuous Current				-0.4	A
DYNAMIC PARAMETERS						
C _{iss}	Input Capacitance	V _{GS} =0V, V _{DS} =-10V, f=1MHz		114	140	pF
C _{oss}	Output Capacitance		17		pF	
C _{rss}	Reverse Transfer Capacitance		14		pF	
R _g	Gate resistance	V _{GS} =0V, V _{DS} =0V, f=1MHz		12	17	Ω
SWITCHING PARAMETERS						
Q _g	Total Gate Charge	V _{GS} =-4.5V, V _{DS} =-10V, I _D =-0.6A		1.44	1.8	nC
Q _{gs}	Gate Source Charge		0.14		nC	
Q _{gd}	Gate Drain Charge		0.35		nC	
t _{D(on)}	Turn-On DelayTime	V _{GS} =-4.5V, V _{DS} =-10V, R _L =16.7Ω, R _{GEN} =3Ω		6.5		ns
t _r	Turn-On Rise Time		6.5		ns	
t _{D(off)}	Turn-Off DelayTime		18.2		ns	
t _f	Turn-Off Fall Time		5.5		ns	
t _{rr}	Body Diode Reverse Recovery Time	I _F =-0.6A, dI/dt=100A/μs		10	13	ns
Q _{rr}	Body Diode Reverse Recovery Charge	I _F =-0.6A, dI/dt=100A/μs		3		nC

A: The value of R_{θJA} is measured with the device mounted on 1in² FR-4 board with 2oz. Copper, in a still air environment with T_A=25° C. The value in any given application depends on the user's specific board design. The current rating is based on the t ≤ 10s thermal resistance rating.

B: Repetitive rating, pulse width limited by junction temperature.

C: The R_{θJA} is the sum of the thermal impedance from junction to lead R_{θJL} and lead to ambient.

D: The static characteristics in Figures 1 to 6,12,14 are obtained using <300 μs pulses, duty cycle 0.5% max.

E: These tests are performed with the device mounted on 1 in² FR-4 board with 2oz. Copper, in a still air environment with T_A=25° C. The SOA curve provides a single pulse rating.

THIS PRODUCT HAS BEEN DESIGNED AND QUALIFIED FOR THE CONSUMER MARKET. APPLICATIONS OR USES AS CRITICAL COMPONENTS IN LIFE SUPPORT DEVICES OR SYSTEMS ARE NOT AUTHORIZED. AOS DOES NOT ASSUME ANY LIABILITY ARISING OUT OF SUCH APPLICATIONS OR USES OF ITS PRODUCTS. AOS RESERVES THE RIGHT TO IMPROVE PRODUCT DESIGN, FUNCTIONS AND RELIABILITY WITHOUT NOTICE.

P-Channel: TYPICAL ELECTRICAL AND THERMAL CHARACTERISTICS

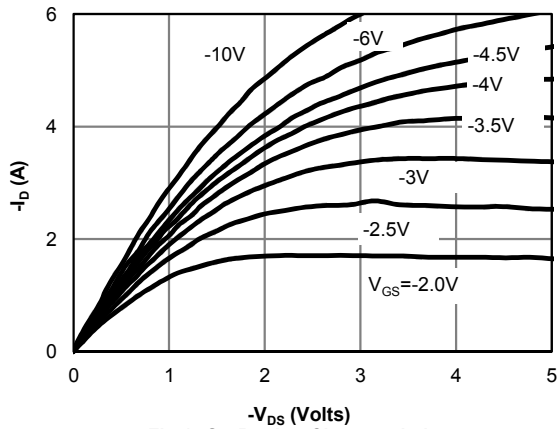

Fig 1: On-Region Characteristics

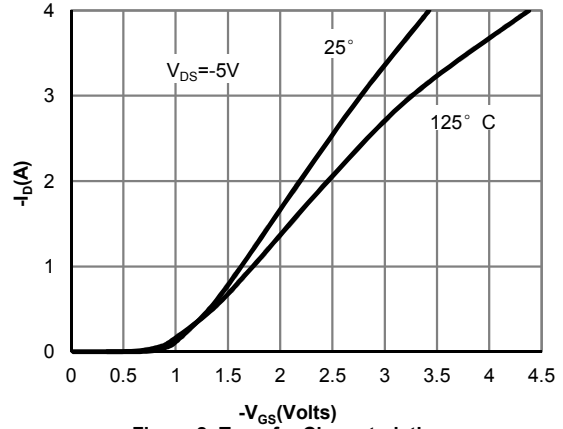

Figure 2: Transfer Characteristics

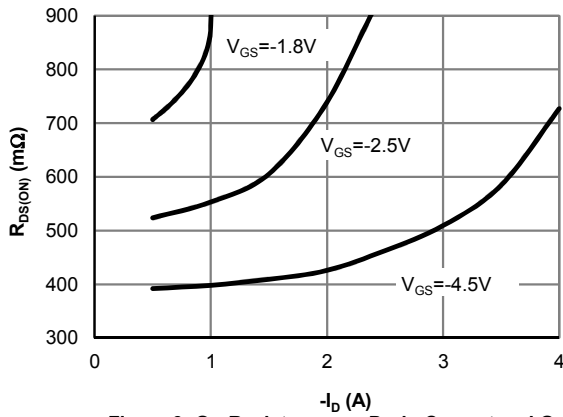

Figure 3: On-Resistance vs. Drain Current and Gate Voltage

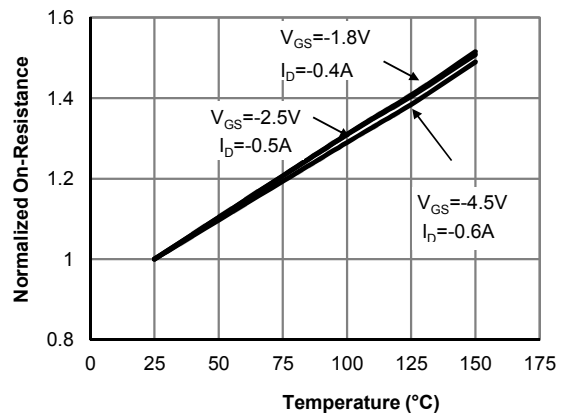

Figure 4: On-Resistance vs. Junction Temperature

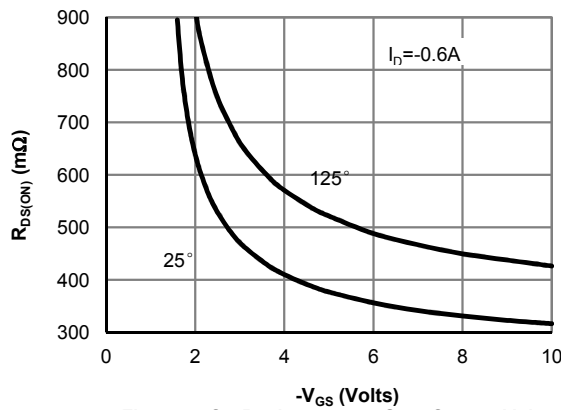

Figure 5: On-Resistance vs. Gate-Source Voltage

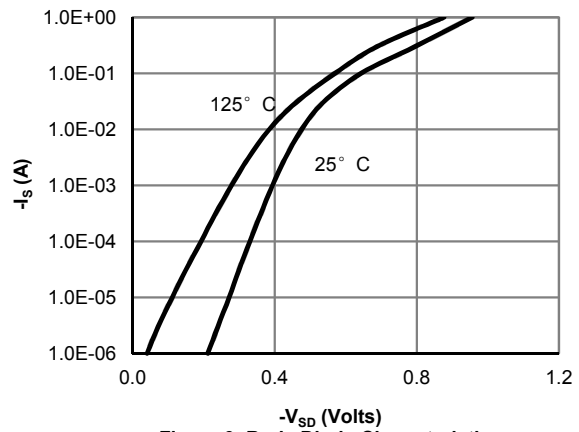

Figure 6: Body-Diode Characteristics

P-Channel: TYPICAL ELECTRICAL AND THERMAL CHARACTERISTICS

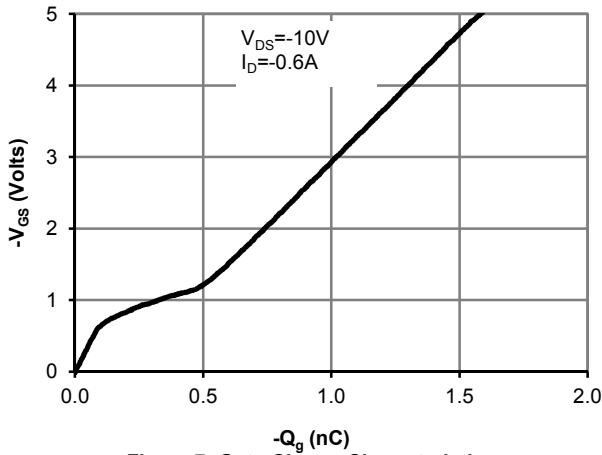

Figure 7: Gate-Charge Characteristics

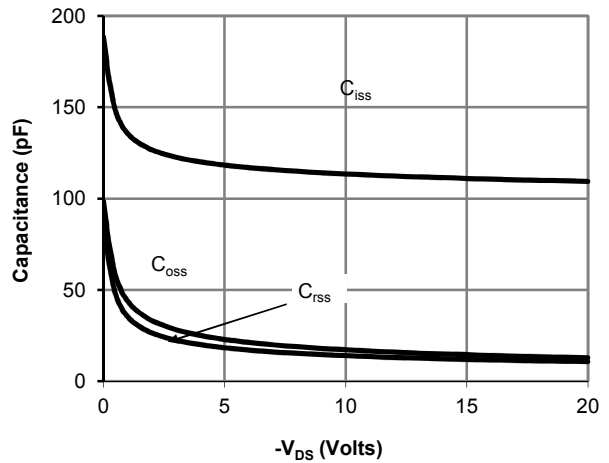

Figure 8: Capacitance Characteristics

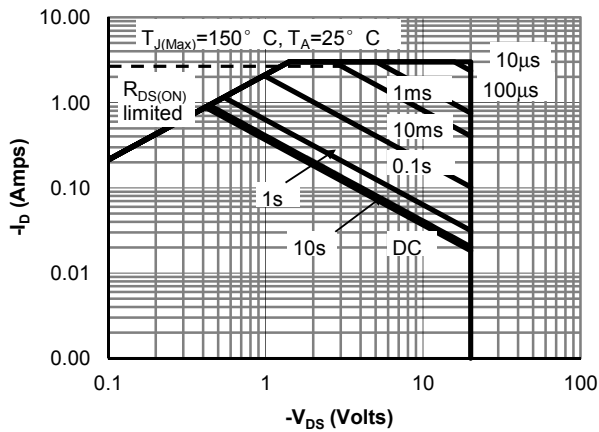

Figure 9: Maximum Forward Biased Safe Operating Area (Note E)

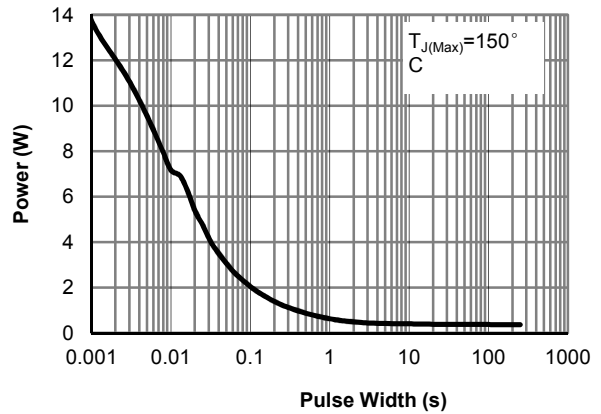

Figure 10: Single Pulse Power Rating Junction-to-Ambient (Note E)

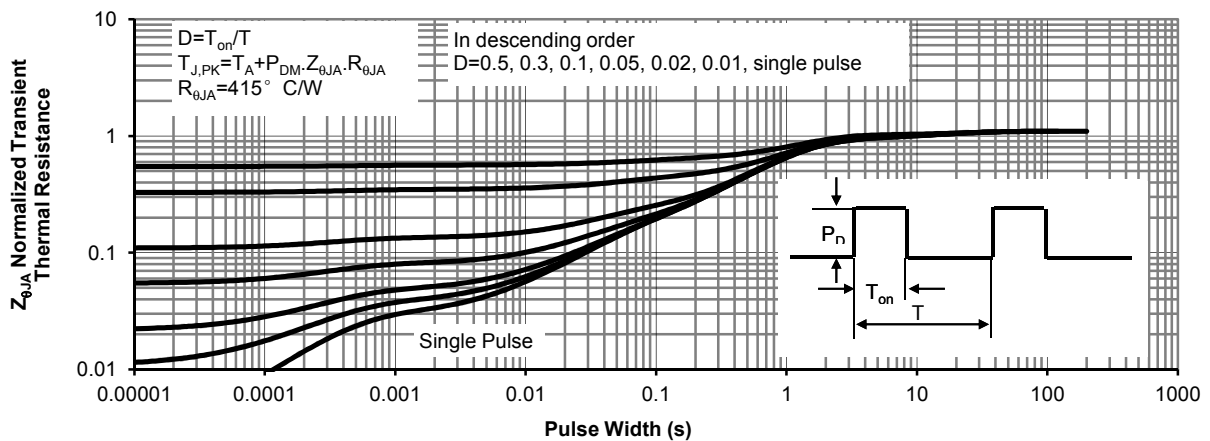
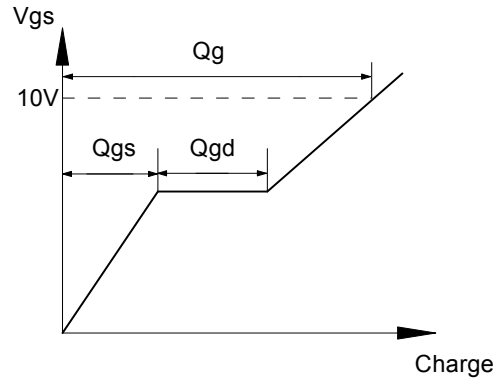
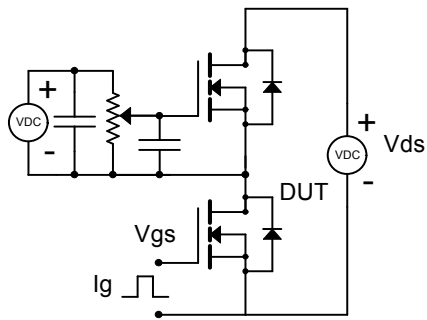
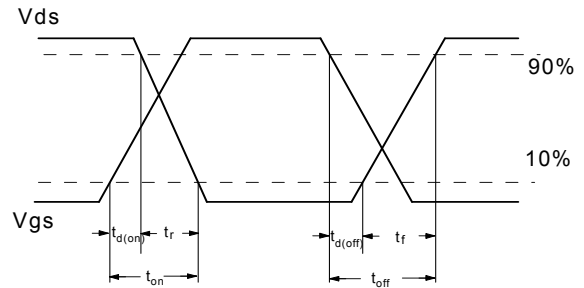
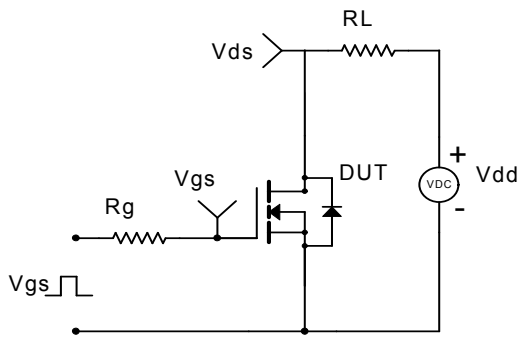

Figure 11: Normalized Maximum Transient Thermal Impedance

Gate Charge Test Circuit & Waveform



Resistive Switching Test Circuit & Waveforms



Diode Recovery Test Circuit & Waveforms

