

BGA2866

MMIC wideband amplifier

Rev. 2 — 1 November 2010

Product data sheet

1. Product profile

1.1 General description

Silicon Monolithic Microwave Integrated Circuit (MMIC) wideband amplifier with internal matching circuit in a 6-pin SOT363 plastic SMD package.

1.2 Features and benefits

- Input internally matched to $50\ \Omega$
- A gain of 23.2 dB at 250 MHz increasing to 24.3 dB at 2150 MHz
- Output power at 1 dB gain compression = 4 dBm
- Supply current = 17.4 mA at a supply voltage of 5 V
- Reverse isolation > 32 dB up to 2150 MHz
- Good linearity with low second order and third order products
- Noise figure = 3.8 dB at 950 MHz
- Unconditionally stable ($K > 1$)
- No output inductor required

1.3 Applications

- LNB IF amplifiers
- General purpose low noise wideband amplifier for frequencies between DC and 2.2 GHz

2. Pinning information

Table 1. Pinning

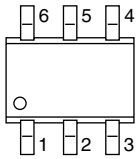
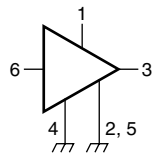
Pin	Description	Simplified outline	Graphic symbol
1	V_{CC}		 sym052
2, 5	GND2		
3	RF_OUT		
4	GND1		
6	RF_IN		

3. Ordering information

Table 2. Ordering information

Type number	Package		Version
	Name	Description	
BGA2866	-	plastic surface-mounted package; 6 leads	SOT363

4. Marking

Table 3. Marking

Type number	Marking code	Description
BGA2866	*ED	* = - : made in Hong Kong
		* = p : made in Hong Kong
		* = W : made in China
		* = t : made in Malaysia

5. Limiting values

Table 4. Limiting values

In accordance with the Absolute Maximum Rating System (IEC 60134).

Symbol	Parameter	Conditions	Min	Max	Unit
V_{CC}	supply voltage	RF input AC coupled	-0.5	5.5	V
I_{CC}	supply current		-	36	mA
P_{tot}	total power dissipation	$T_{sp} = 90\text{ °C}$	-	200	mW
T_{stg}	storage temperature		-40	+125	°C
T_j	junction temperature		-	125	°C
P_{drive}	drive power		-	-15	dBm

6. Thermal characteristics

Table 5. Thermal characteristics

Symbol	Parameter	Conditions	Typ	Unit
$R_{th(j-sp)}$	thermal resistance from junction to solder point	$P_{tot} = 200\text{ mW}$; $T_{sp} = 90\text{ °C}$	300	K/W

7. Characteristics

Table 6. Characteristics

$V_{CC} = 5.0\text{ V}$; $Z_S = Z_L = 50\ \Omega$; $P_i = -40\text{ dBm}$; $T_{amb} = 25\text{ °C}$; measured on demo board; unless otherwise specified.

Symbol	Parameter	Conditions	Min	Typ	Max	Unit
V_{CC}	supply voltage		4.5	5.0	5.5	V
I_{CC}	supply current		14.7	17.4	20.1	mA

Table 6. Characteristics ...continued

$V_{CC} = 5.0\text{ V}$; $Z_S = Z_L = 50\ \Omega$; $P_i = -40\text{ dBm}$; $T_{amb} = 25\text{ }^\circ\text{C}$; measured on demo board; unless otherwise specified.

Symbol	Parameter	Conditions	Min	Typ	Max	Unit
G _p	power gain	f = 250 MHz	22.6	23.2	23.8	dB
		f = 950 MHz	23.2	23.9	24.6	dB
		f = 2150 MHz	22.8	24.3	25.8	dB
RL _{in}	input return loss	f = 250 MHz	18	20	22	dB
		f = 950 MHz	24	26	28	dB
		f = 2150 MHz	11	18	24	dB
RL _{out}	output return loss	f = 250 MHz	21	26	30	dB
		f = 950 MHz	12	13	14	dB
		f = 2150 MHz	10	11	14	dB
ISL	isolation	f = 250 MHz	40	60	81	dB
		f = 950 MHz	41	43	44	dB
		f = 2150 MHz	32	35	37	dB
NF	noise figure	f = 250 MHz	3.4	3.9	4.4	dB
		f = 950 MHz	3.4	3.8	4.2	dB
		f = 2150 MHz	3.5	3.9	4.3	dB
B _{-3dB}	-3 dB bandwidth	3 dB below gain at 1 GHz	3.1	3.3	3.4	GHz
K	Rollett stability factor	f = 250 MHz	33	35	37	
		f = 950 MHz	3.8	4.1	4.4	
		f = 2150 MHz	1.3	1.6	1.9	
P _{L(sat)}	saturated output power	f = 250 MHz	5	6	7	dBm
		f = 950 MHz	5	7	8	dBm
		f = 2150 MHz	2	4	5	dBm
P _{L(1dB)}	output power at 1 dB gain compression	f = 250 MHz	3	4	5	dBm
		f = 950 MHz	3	4	5	dBm
		f = 2150 MHz	1	3	4	dBm
IP3 _I	input third-order intercept point	P _{drive} = -36 dBm (for each tone)				
		f ₁ = 250 MHz; f ₂ = 251 MHz	-6	-4	-2	dBm
		f ₁ = 950 MHz; f ₂ = 951 MHz	-9	-7	-4	dBm
		f ₁ = 2150 MHz; f ₂ = 2151 MHz	-16	-12	-9	dBm
IP3 _O	output third-order intercept point	P _{drive} = -36 dBm (for each tone)				
		f ₁ = 250 MHz; f ₂ = 251 MHz	17	19	21	dBm
		f ₁ = 950 MHz; f ₂ = 951 MHz	15	17	20	dBm
		f ₁ = 2150 MHz; f ₂ = 2151 MHz	9	12	15	dBm
P _{L(2H)}	second harmonic output power	P _{drive} = -33 dBm				
		f _{1H} = 250 MHz; f _{2H} = 500 MHz	-53	-51	-49	dBm
		f _{1H} = 950 MHz; f _{2H} = 1900 MHz	-43	-41	-40	dBm
ΔIM2	second-order intermodulation distance	P _{drive} = -36 dBm (for each tone)				
		f ₁ = 250 MHz; f ₂ = 251 MHz	36	47	58	dBc
		f ₁ = 950 MHz; f ₂ = 951 MHz	32	43	55	dBc

8. Application information

[Figure 1](#) shows a typical application circuit for the BGA2866 MMIC. The device is internally matched to 50 Ω and therefore does not need any external matching. The value of the input and output DC blocking capacitors C2 and C3 should not be more than 100 pF for applications above 100 MHz. However, when the device is operated below 100 MHz, the capacitor value should be increased.

The 22 nF supply decoupling capacitor C1 should be located as close as possible to the MMIC.

The PCB top ground plane, connected to pins 2, 4 and 5 must be as close as possible to the MMIC, preferably also below the MMIC. When using via holes, use multiple via holes as close as possible to the MMIC.

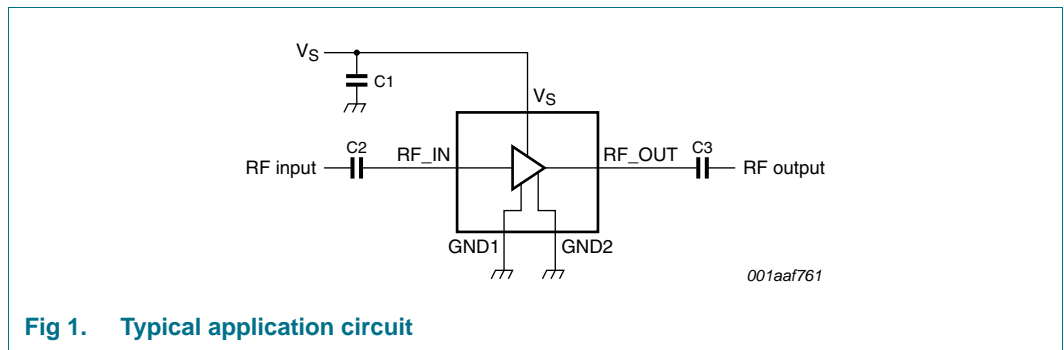
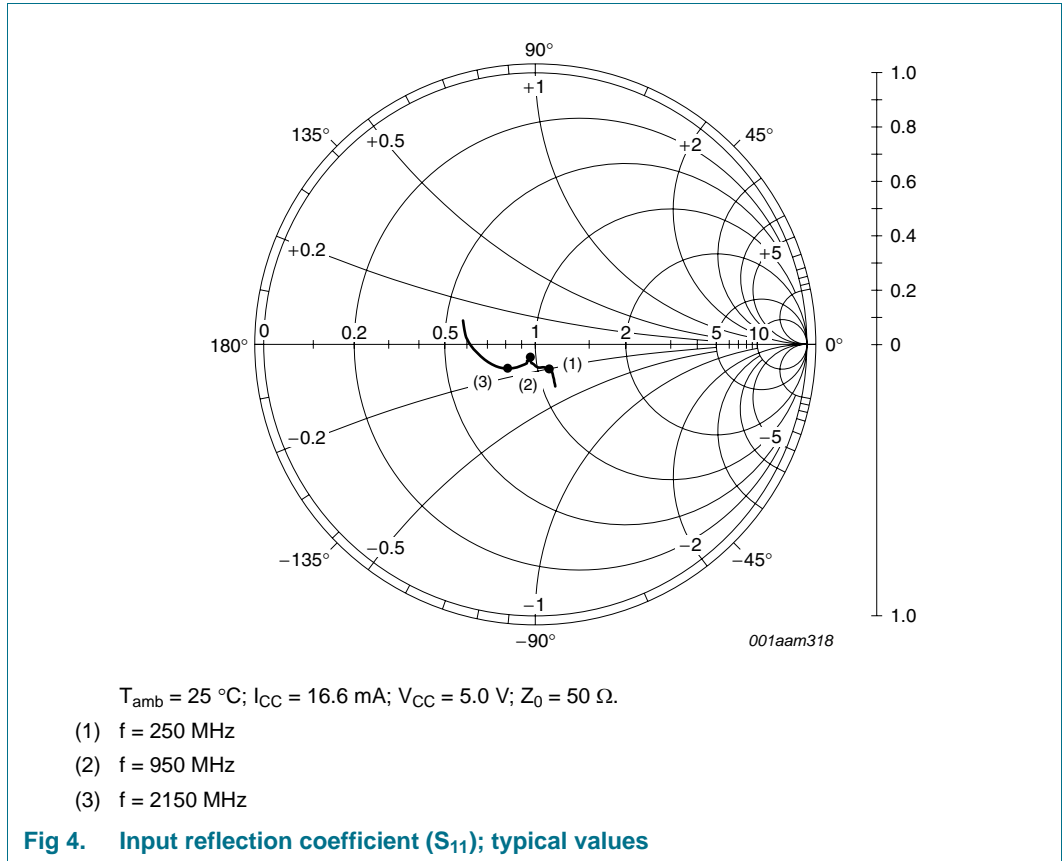

Fig 1. Typical application circuit

8.1 Application examples

<p>The MMIC is very suitable as IF amplifier in e.g. LNB's. The excellent wideband characteristics make it an easy building block.</p>	<p>As second amplifier after an LNA, the MMIC offers an easy matching, low noise solution.</p>
<p>Fig 2. Application as IF amplifier</p>	<p>Fig 3. Application as RF amplifier</p>

8.2 Graphs



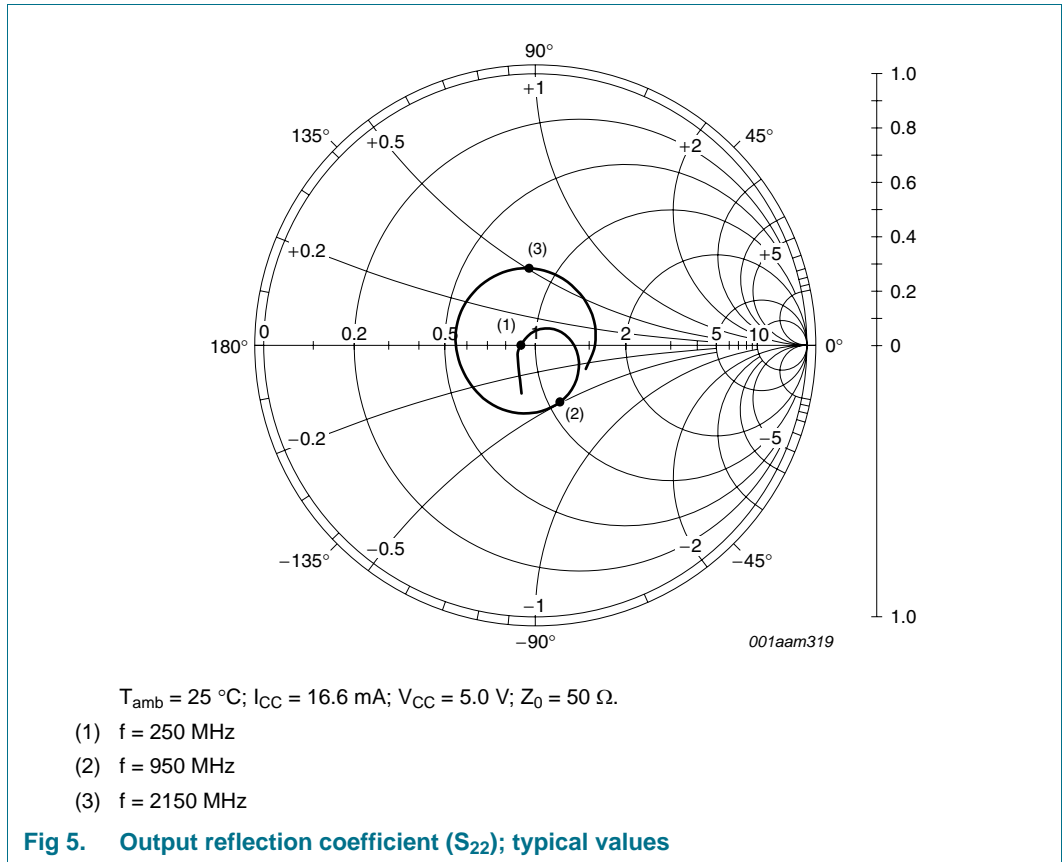

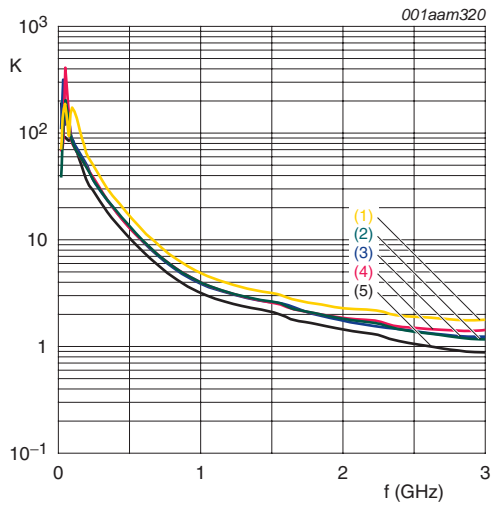

$P_{drive} = -40 \text{ dBm}; Z_0 = 50 \Omega.$

- (1) $V_{CC} = 4.5 \text{ V}; T_{amb} = 85 \text{ }^\circ\text{C}; I_{CC} = 14.36 \text{ mA}$
- (2) $V_{CC} = 4.5 \text{ V}; T_{amb} = -40 \text{ }^\circ\text{C}; I_{CC} = 16.41 \text{ mA}$
- (3) $V_{CC} = 5.0 \text{ V}; T_{amb} = 25 \text{ }^\circ\text{C}; I_{CC} = 16.63 \text{ mA}$
- (4) $V_{CC} = 5.5 \text{ V}; T_{amb} = 85 \text{ }^\circ\text{C}; I_{CC} = 17.27 \text{ mA}$
- (5) $V_{CC} = 5.5 \text{ V}; T_{amb} = -40 \text{ }^\circ\text{C}; I_{CC} = 19.29 \text{ mA}$

Fig 6. Rollett stability factor as function of frequency; typical values

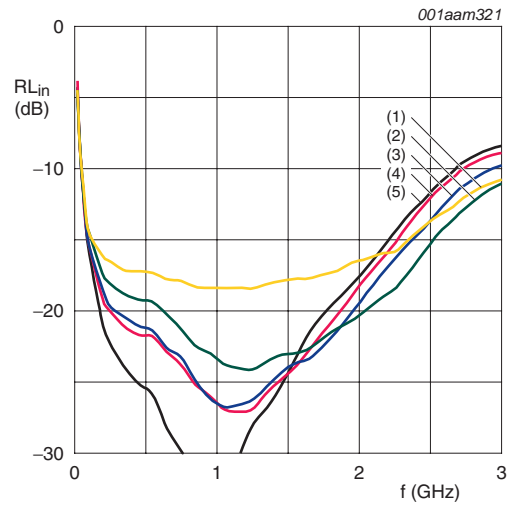

$P_{drive} = -40 \text{ dBm}; Z_0 = 50 \Omega.$

- (1) $V_{CC} = 4.5 \text{ V}; T_{amb} = 85 \text{ }^\circ\text{C}; I_{CC} = 14.36 \text{ mA}$
- (2) $V_{CC} = 4.5 \text{ V}; T_{amb} = -40 \text{ }^\circ\text{C}; I_{CC} = 16.41 \text{ mA}$
- (3) $V_{CC} = 5.0 \text{ V}; T_{amb} = 25 \text{ }^\circ\text{C}; I_{CC} = 16.63 \text{ mA}$
- (4) $V_{CC} = 5.5 \text{ V}; T_{amb} = 85 \text{ }^\circ\text{C}; I_{CC} = 17.27 \text{ mA}$
- (5) $V_{CC} = 5.5 \text{ V}; T_{amb} = -40 \text{ }^\circ\text{C}; I_{CC} = 19.29 \text{ mA}$

Fig 7. Input return loss as function of frequency; typical values

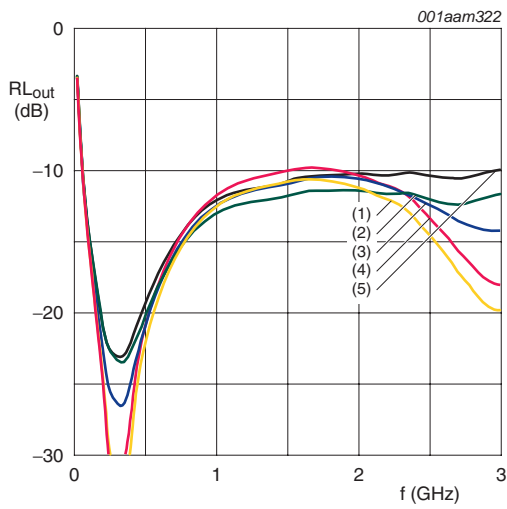

- $P_{drive} = -40 \text{ dBm}; Z_0 = 50 \Omega.$
- (1) $V_{CC} = 4.5 \text{ V}; T_{amb} = 85 \text{ }^\circ\text{C}; I_{CC} = 14.36 \text{ mA}$
 - (2) $V_{CC} = 4.5 \text{ V}; T_{amb} = -40 \text{ }^\circ\text{C}; I_{CC} = 16.41 \text{ mA}$
 - (3) $V_{CC} = 5.0 \text{ V}; T_{amb} = 25 \text{ }^\circ\text{C}; I_{CC} = 16.63 \text{ mA}$
 - (4) $V_{CC} = 5.5 \text{ V}; T_{amb} = 85 \text{ }^\circ\text{C}; I_{CC} = 17.27 \text{ mA}$
 - (5) $V_{CC} = 5.5 \text{ V}; T_{amb} = -40 \text{ }^\circ\text{C}; I_{CC} = 19.29 \text{ mA}$

Fig 8. Output return loss as function of frequency; typical values

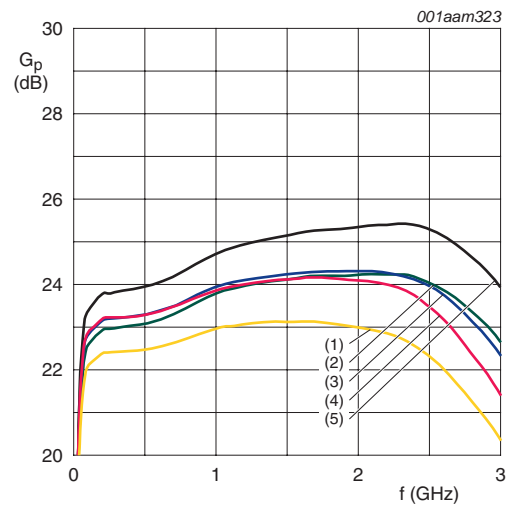

- $P_{drive} = -40 \text{ dBm}; Z_0 = 50 \Omega.$
- (1) $V_{CC} = 4.5 \text{ V}; T_{amb} = 85 \text{ }^\circ\text{C}; I_{CC} = 14.36 \text{ mA}$
 - (2) $V_{CC} = 4.5 \text{ V}; T_{amb} = -40 \text{ }^\circ\text{C}; I_{CC} = 16.41 \text{ mA}$
 - (3) $V_{CC} = 5.0 \text{ V}; T_{amb} = 25 \text{ }^\circ\text{C}; I_{CC} = 16.63 \text{ mA}$
 - (4) $V_{CC} = 5.5 \text{ V}; T_{amb} = 85 \text{ }^\circ\text{C}; I_{CC} = 17.27 \text{ mA}$
 - (5) $V_{CC} = 5.5 \text{ V}; T_{amb} = -40 \text{ }^\circ\text{C}; I_{CC} = 19.29 \text{ mA}$

Fig 9. Insertion power gain as function of frequency; typical values

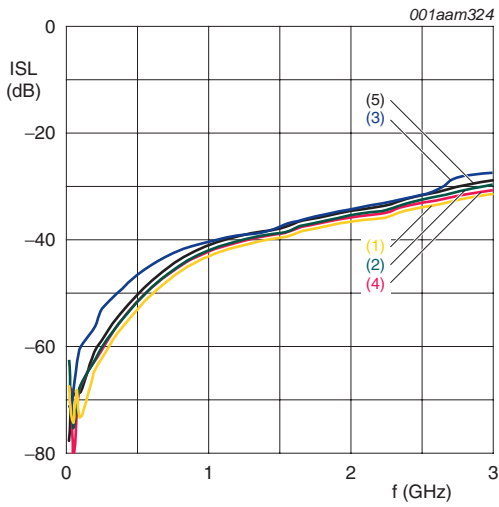

$P_{drive} = -40 \text{ dBm}; Z_0 = 50 \Omega.$
 (1) $V_{CC} = 4.5 \text{ V}; T_{amb} = 85 \text{ }^\circ\text{C}; I_{CC} = 14.36 \text{ mA}$
 (2) $V_{CC} = 4.5 \text{ V}; T_{amb} = -40 \text{ }^\circ\text{C}; I_{CC} = 16.41 \text{ mA}$
 (3) $V_{CC} = 5.0 \text{ V}; T_{amb} = 25 \text{ }^\circ\text{C}; I_{CC} = 16.63 \text{ mA}$
 (4) $V_{CC} = 5.5 \text{ V}; T_{amb} = 85 \text{ }^\circ\text{C}; I_{CC} = 17.27 \text{ mA}$
 (5) $V_{CC} = 5.5 \text{ V}; T_{amb} = -40 \text{ }^\circ\text{C}; I_{CC} = 19.29 \text{ mA}$

Fig 10. Isolation as function of frequency; typical values

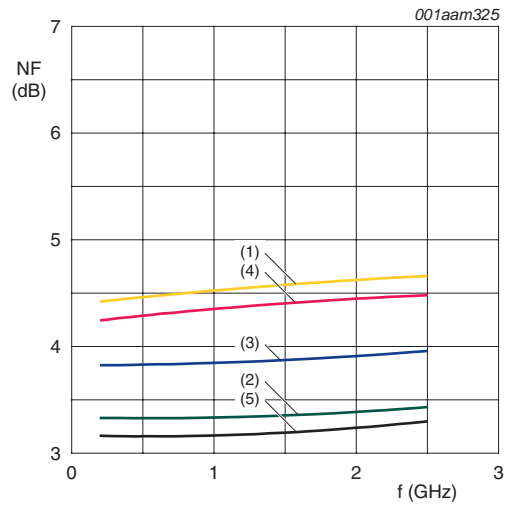

$Z_0 = 50 \Omega.$
 (1) $V_{CC} = 4.5 \text{ V}; T_{amb} = 85 \text{ }^\circ\text{C}; I_{CC} = 14.36 \text{ mA}$
 (2) $V_{CC} = 4.5 \text{ V}; T_{amb} = -40 \text{ }^\circ\text{C}; I_{CC} = 16.41 \text{ mA}$
 (3) $V_{CC} = 5.0 \text{ V}; T_{amb} = 25 \text{ }^\circ\text{C}; I_{CC} = 16.63 \text{ mA}$
 (4) $V_{CC} = 5.5 \text{ V}; T_{amb} = 85 \text{ }^\circ\text{C}; I_{CC} = 17.27 \text{ mA}$
 (5) $V_{CC} = 5.5 \text{ V}; T_{amb} = -40 \text{ }^\circ\text{C}; I_{CC} = 19.29 \text{ mA}$

Fig 11. Noise figure as function of frequency; typical values

8.3 Tables

Table 7. Supply current over temperature and supply voltages
Typical values.

Symbol	Parameter	Conditions	T _{amb} (°C)			Unit
			-40	25	85	
I _{CC}	supply current	V _{CC} = 4.5 V	16.41	15.27	14.36	mA
		V _{CC} = 5.0 V	17.73	16.63	15.85	
		V _{CC} = 5.5 V	19.29	17.73	17.27	

Table 8. Second harmonic output power over temperature and supply voltages
Typical values.

Symbol	Parameter	Conditions	T _{amb} (°C)			Unit
			-40	25	85	
P _{L(2H)}	second harmonic output power	f = 250 MHz; P _{drive} = -33 dBm	-48	-49	-51	dBm
		V _{CC} = 4.5 V				
		V _{CC} = 5.0 V				
		V _{CC} = 5.5 V	-50	-52	-54	
		f = 950 MHz; P _{drive} = -33 dBm				
		V _{CC} = 4.5 V				
		V _{CC} = 5.0 V				
		V _{CC} = 5.5 V				

Table 9. Input power at 1 dB gain compression over temperature and supply voltages
Typical values.

Symbol	Parameter	Conditions	T _{amb} (°C)			Unit
			-40	25	85	
P _{i(1dB)}	input power at 1 dB gain compression	f = 250 MHz				
		V _{CC} = 4.5 V	-18	-18	-19	dBm
		V _{CC} = 5.0 V	-18	-18	-18	dBm
		V _{CC} = 5.5 V	-17	-18	-18	dBm
		f = 950 MHz				
		V _{CC} = 4.5 V	-19	-19	-19	dBm
		V _{CC} = 5.0 V	-18	-18	-19	dBm
		V _{CC} = 5.5 V	-18	-18	-18	dBm
		f = 2150 MHz				
		V _{CC} = 4.5 V	-20	-21	-22	dBm
		V _{CC} = 5.0 V	-20	-21	-22	dBm
		V _{CC} = 5.5 V	-20	-21	-22	dBm

Table 10. Output power at 1 dB gain compression over temperature and supply voltages
Typical values.

Symbol	Parameter	Conditions	T _{amb} (°C)			Unit
			-40	25	85	
P _{L(1dB)}	output power at 1 dB gain compression	f = 250 MHz				
		V _{CC} = 4.5 V	4	3	3	dBm
		V _{CC} = 5.0 V	5	4	4	dBm
		V _{CC} = 5.5 V	5	5	4	dBm
		f = 950 MHz				
		V _{CC} = 4.5 V	4	3	3	dBm
		V _{CC} = 5.0 V	5	4	4	dBm
		V _{CC} = 5.5 V	6	5	4	dBm
		f = 2150 MHz				
		V _{CC} = 4.5 V	3	2	0	dBm
		V _{CC} = 5.0 V	4	2	1	dBm
		V _{CC} = 5.5 V	4	3	1	dBm

Table 11. Saturated output power over temperature and supply voltages
Typical values.

Symbol	Parameter	Conditions	T _{amb} (°C)			Unit
			-40	25	85	
P _{L(sat)}	saturated output power	f = 250 MHz				
		V _{CC} = 4.5 V	6	5	5	dBm
		V _{CC} = 5.0 V	7	6	6	dBm
		V _{CC} = 5.5 V	8	7	6	dBm
		f = 950 MHz				
		V _{CC} = 4.5 V	6	5	5	dBm
		V _{CC} = 5.0 V	7	7	5	dBm
		V _{CC} = 5.5 V	8	7	6	dBm
		f = 2150 MHz				
		V _{CC} = 4.5 V	4	3	2	dBm
		V _{CC} = 5.0 V	5	4	2	dBm
		V _{CC} = 5.5 V	5	4	2	dBm

Table 12. Second-order intermodulation distance over temperature and supply voltages
Typical values.

Symbol	Parameter	Conditions	T _{amb} (°C)			Unit
			-40	25	85	
ΔIM2	second-order intermodulation distance	f ₁ = 250 MHz; f ₂ = 251 MHz; P _{drive} = -36 dBm				
		V _{CC} = 4.5 V	40	42	46	dBc
		V _{CC} = 5.0 V	44	47	51	dBc
		V _{CC} = 5.5 V	48	51	56	dBc
		f ₁ = 950 MHz; f ₂ = 951 MHz; P _{drive} = -36 dBm				
		V _{CC} = 4.5 V	38	40	43	dBc
		V _{CC} = 5.0 V	42	43	45	dBc
		V _{CC} = 5.5 V	45	46	46	dBc

Table 13. Output third-order intercept point over temperature and supply voltages
Typical values.

Symbol	Parameter	Conditions	T _{amb} (°C)			Unit	
			-40	25	85		
IP _{3O}	output third-order intercept point	f ₁ = 250 MHz; f ₂ = 251 MHz; P _{drive} = -36 dBm	V _{CC} = 4.5 V	18	18	17	dBm
			V _{CC} = 5.0 V	20	19	18	dBm
			V _{CC} = 5.5 V	21	19	19	dBm
		f ₁ = 950 MHz; f ₂ = 951 MHz; P _{drive} = -36 dBm	V _{CC} = 4.5 V	17	16	15	dBm
			V _{CC} = 5.0 V	18	17	16	dBm
			V _{CC} = 5.5 V	20	18	16	dBm
		f ₁ = 2150 MHz; f ₂ = 2151 MHz; P _{drive} = -36 dBm	V _{CC} = 4.5 V	13	11	9	dBm
			V _{CC} = 5.0 V	14	12	9	dBm
			V _{CC} = 5.5 V	15	12	10	dBm

Table 14. -3 dB bandwidth over temperature and supply voltages
Typical values.

Symbol	Parameter	Conditions	T _{amb} (°C)			Unit
			-40	25	85	
B _{-3dB}	-3 dB bandwidth	V _{CC} = 4.5 V	3.375	3.245	3.059	GHz
		V _{CC} = 5.0 V	3.399	3.265	3.069	GHz
		V _{CC} = 5.5 V	3.416	3.278	3.078	GHz

9. Test information

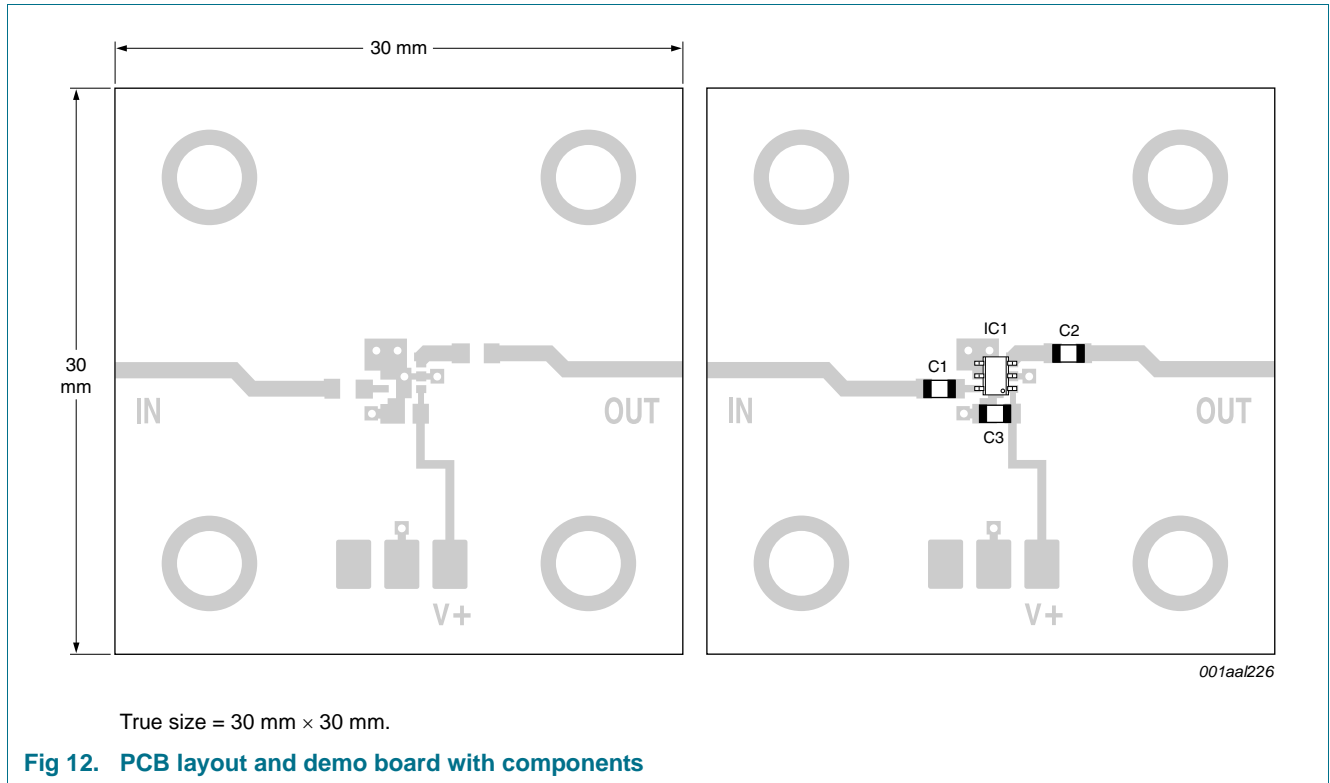

Table 15. List of components used for the typical application

Component	Description	Value	Dimensions
C1, C2	multilayer ceramic chip capacitor	100 pF	0603
C3	multilayer ceramic chip capacitor	22 nF	0603
IC1	BGA2866 MMIC		SOT363

10. Package outline

Plastic surface-mounted package; 6 leads

SOT363

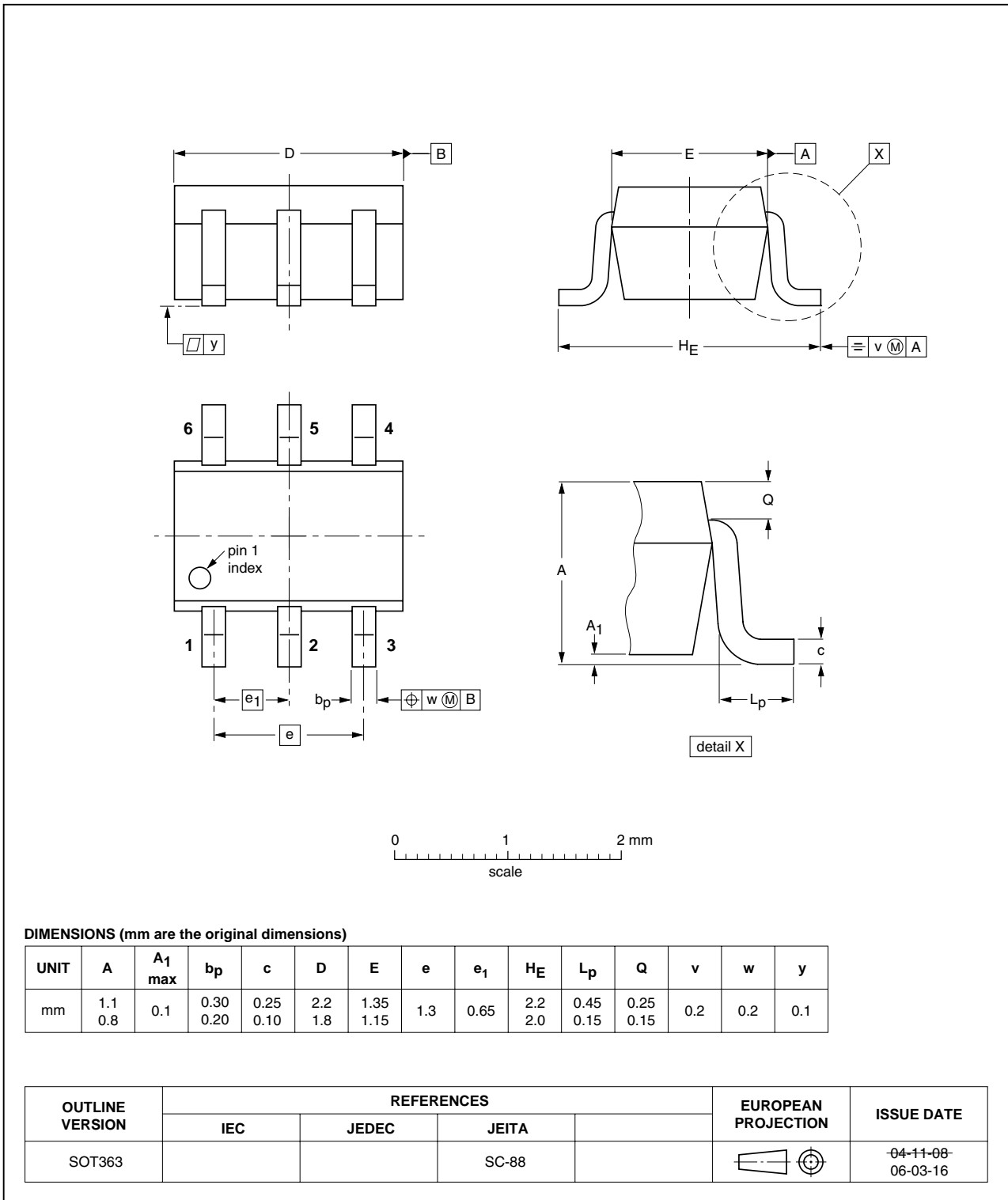

Fig 13. Package outline SOT363

11. Abbreviations

Table 16. Abbreviations

Acronym	Description
DC	Direct Current
IF	Intermediate Frequency
LNA	Low-Noise Amplifier
LNB	Low-Noise Block converter
PCB	Printed-Circuit Board
RF	Radio Frequency
SMD	Surface Mounted Device

12. Revision history

Table 17. Revision history

Document ID	Release date	Data sheet status	Change notice	Supersedes
BGA2866 v.2	20101101	Product data sheet	-	BGA2866 v.1
Modifications	<ul style="list-style-type: none">• Table 4 on page 2: The minimum value for V_{CC} has been changed to -0.5 V			
BGA2866 v.1	20100817	Product data sheet	-	-

13. Legal information

13.1 Data sheet status

Document status ^{[1][2]}	Product status ^[3]	Definition
Objective [short] data sheet	Development	This document contains data from the objective specification for product development.
Preliminary [short] data sheet	Qualification	This document contains data from the preliminary specification.
Product [short] data sheet	Production	This document contains the product specification.

[1] Please consult the most recently issued document before initiating or completing a design.

[2] The term 'short data sheet' is explained in section "Definitions".

[3] The product status of device(s) described in this document may have changed since this document was published and may differ in case of multiple devices. The latest product status information is available on the Internet at URL <http://www.nxp.com>.

13.2 Definitions

Draft — The document is a draft version only. The content is still under internal review and subject to formal approval, which may result in modifications or additions. NXP Semiconductors does not give any representations or warranties as to the accuracy or completeness of information included herein and shall have no liability for the consequences of use of such information.

Short data sheet — A short data sheet is an extract from a full data sheet with the same product type number(s) and title. A short data sheet is intended for quick reference only and should not be relied upon to contain detailed and full information. For detailed and full information see the relevant full data sheet, which is available on request via the local NXP Semiconductors sales office. In case of any inconsistency or conflict with the short data sheet, the full data sheet shall prevail.

Product specification — The information and data provided in a Product data sheet shall define the specification of the product as agreed between NXP Semiconductors and its customer, unless NXP Semiconductors and customer have explicitly agreed otherwise in writing. In no event however, shall an agreement be valid in which the NXP Semiconductors product is deemed to offer functions and qualities beyond those described in the Product data sheet.

13.3 Disclaimers

Limited warranty and liability — Information in this document is believed to be accurate and reliable. However, NXP Semiconductors does not give any representations or warranties, expressed or implied, as to the accuracy or completeness of such information and shall have no liability for the consequences of use of such information.

In no event shall NXP Semiconductors be liable for any indirect, incidental, punitive, special or consequential damages (including - without limitation - lost profits, lost savings, business interruption, costs related to the removal or replacement of any products or rework charges) whether or not such damages are based on tort (including negligence), warranty, breach of contract or any other legal theory.

Notwithstanding any damages that customer might incur for any reason whatsoever, NXP Semiconductors' aggregate and cumulative liability towards customer for the products described herein shall be limited in accordance with the *Terms and conditions of commercial sale* of NXP Semiconductors.

Right to make changes — NXP Semiconductors reserves the right to make changes to information published in this document, including without limitation specifications and product descriptions, at any time and without notice. This document supersedes and replaces all information supplied prior to the publication hereof.

Suitability for use — NXP Semiconductors products are not designed, authorized or warranted to be suitable for use in life support, life-critical or safety-critical systems or equipment, nor in applications where failure or

malfunction of an NXP Semiconductors product can reasonably be expected to result in personal injury, death or severe property or environmental damage. NXP Semiconductors accepts no liability for inclusion and/or use of NXP Semiconductors products in such equipment or applications and therefore such inclusion and/or use is at the customer's own risk.

Applications — Applications that are described herein for any of these products are for illustrative purposes only. NXP Semiconductors makes no representation or warranty that such applications will be suitable for the specified use without further testing or modification.

Customers are responsible for the design and operation of their applications and products using NXP Semiconductors products, and NXP Semiconductors accepts no liability for any assistance with applications or customer product design. It is customer's sole responsibility to determine whether the NXP Semiconductors product is suitable and fit for the customer's applications and products planned, as well as for the planned application and use of customer's third party customer(s). Customers should provide appropriate design and operating safeguards to minimize the risks associated with their applications and products.

NXP Semiconductors does not accept any liability related to any default, damage, costs or problem which is based on any weakness or default in the customer's applications or products, or the application or use by customer's third party customer(s). Customer is responsible for doing all necessary testing for the customer's applications and products using NXP Semiconductors products in order to avoid a default of the applications and the products or of the application or use by customer's third party customer(s). NXP does not accept any liability in this respect.

Limiting values — Stress above one or more limiting values (as defined in the Absolute Maximum Ratings System of IEC 60134) will cause permanent damage to the device. Limiting values are stress ratings only and (proper) operation of the device at these or any other conditions above those given in the Recommended operating conditions section (if present) or the Characteristics sections of this document is not warranted. Constant or repeated exposure to limiting values will permanently and irreversibly affect the quality and reliability of the device.

Terms and conditions of commercial sale — NXP Semiconductors products are sold subject to the general terms and conditions of commercial sale, as published at <http://www.nxp.com/profile/terms>, unless otherwise agreed in a valid written individual agreement. In case an individual agreement is concluded only the terms and conditions of the respective agreement shall apply. NXP Semiconductors hereby expressly objects to applying the customer's general terms and conditions with regard to the purchase of NXP Semiconductors products by customer.

No offer to sell or license — Nothing in this document may be interpreted or construed as an offer to sell products that is open for acceptance or the grant, conveyance or implication of any license under any copyrights, patents or other industrial or intellectual property rights.

Export control — This document as well as the item(s) described herein may be subject to export control regulations. Export might require a prior authorization from national authorities.

Non-automotive qualified products — Unless this data sheet expressly states that this specific NXP Semiconductors product is automotive qualified, the product is not suitable for automotive use. It is neither qualified nor tested in accordance with automotive testing or application requirements. NXP Semiconductors accepts no liability for inclusion and/or use of non-automotive qualified products in automotive equipment or applications.

In the event that customer uses the product for design-in and use in automotive applications to automotive specifications and standards, customer (a) shall use the product without NXP Semiconductors' warranty of the product for such automotive applications, use and specifications, and (b) whenever customer uses the product for automotive applications beyond

NXP Semiconductors' specifications such use shall be solely at customer's own risk, and (c) customer fully indemnifies NXP Semiconductors for any liability, damages or failed product claims resulting from customer design and use of the product for automotive applications beyond NXP Semiconductors' standard warranty and NXP Semiconductors' product specifications.

13.4 Trademarks

Notice: All referenced brands, product names, service names and trademarks are the property of their respective owners.

14. Contact information

For more information, please visit: <http://www.nxp.com>

For sales office addresses, please send an email to: salesaddresses@nxp.com

15. Contents

1	Product profile	1
1.1	General description	1
1.2	Features and benefits	1
1.3	Applications	1
2	Pinning information	1
3	Ordering information	2
4	Marking	2
5	Limiting values	2
6	Thermal characteristics	2
7	Characteristics	2
8	Application information	4
8.1	Application examples	4
8.2	Graphs	5
8.3	Tables	9
9	Test information	13
10	Package outline	14
11	Abbreviations	15
12	Revision history	15
13	Legal information	16
13.1	Data sheet status	16
13.2	Definitions	16
13.3	Disclaimers	16
13.4	Trademarks	17
14	Contact information	17
15	Contents	18

Please be aware that important notices concerning this document and the product(s) described herein, have been included in section 'Legal information'.

© NXP B.V. 2010.

All rights reserved.

For more information, please visit: <http://www.nxp.com>

For sales office addresses, please send an email to: salesaddresses@nxp.com

Date of release: 1 November 2010

Document identifier: BGA2866