

MOD-PULSE development board

Users Manual



All boards produced by Olimex are ROHS compliant

Revision Initial, March 2011

Copyright(c) 2011, OLIMEX Ltd, All rights reserved

INTRODUCTION:

MOD-PULSE is an instrument for monitoring the blood oxygenation of a human. By measuring the oxygen level and heart rate, MOD-PULSE can display the levels of blood oxygenation and heart rate on it's LCD display. To perform it's functionality, MOD-PULSE requires external sensor connected to it via PROBE connector. MOD-PULSE can be connected to variety of OLIMEX's development boards via it's UEXT connector.

BOARD FEATURES:

- MCU: **MSP430FG439**
- JTAG
- UEXT
- custom LCD
- two user buttons
- two status leds
- power supply switch
- +3V lithium battery connector
- Battery connector for 2 x 1.5V AA batteries
- DB9 - Female connector
- System clock crystal
- extension pin holes for each microcontroller's ports
- FR-4, 1.5 mm, red soldermask, component print
- Dimensions: 134.6x101.6mm (5.3 x 4.0")

ELECTROSTATIC WARNING:

The **MOD-PULSE** board is shipped in protective anti-static packaging. The board must not be subject to high electrostatic potentials. General practice for working with static sensitive devices should be applied when working with this board.

BOARD USE REQUIREMENTS:

Cables: The cable you will need depends on the programmer/debugger you use. If you use MSP430-JTAG-TINY, MSP430-JTAG-TINY-V2, or MSP430-JTAG-ISO, you will need USB A-B cable. If you use MSP430-JTAG, you will need LPT cable.

Hardware: Programmer/Debugger [MSP430-JTAG](#), [MSP430-JTAG-TINY](#), MSP430-JTAG-TINY-V2, [MSP430-JTAG-ISO](#), or other compatible programming/ debugging tool.

PROCESSOR FEATURES:

MOD-PULSE board uses ultralow power microcontroller **MSP430FG439** from Texas Instruments with these features:

- Low Supply-Voltage Range, 1.8 V to 3.6 V
- Ultralow-Power Consumption:
 - Active Mode: 300 μ A at 1 MHz, 2.2 V
 - Standby Mode: 1.1 μ A
 - Off Mode (RAM Retention): 0.1 μ A
- Five Power Saving Modes
- Wake-Up From Standby Mode in Less Than 6 μ s
- 16-Bit RISC Architecture, 125-ns Instruction Cycle Time
- Single-Channel Internal DMA
- 12-Bit A/D Converter With Internal Reference, Sample-and-Hold and Autoscan Feature
- Three Configurable Operational Amplifiers
- Dual 12-Bit D/A Converters With Synchronization
- 16-Bit Timer_A With Three Capture/Compare Registers
- 16-Bit Timer_B With Three Capture/Compare-With-Shadow Registers
- On-Chip Comparator
- Serial Communication Interface (USART), Select Asynchronous UART or Synchronous SPI by Software
- Brownout Detector
- Supply Voltage Supervisor/Monitor With Programmable Level Detection
- Bootstrap Loader
- Serial Onboard Programming, No External Programming Voltage Needed
Programmable Code Protection by Security Fuse
- Integrated LCD Driver for Up to 128 Segments
- 60KB+256B Flash Memory
- 2KB RAM

BLOCK DIAGRAM:

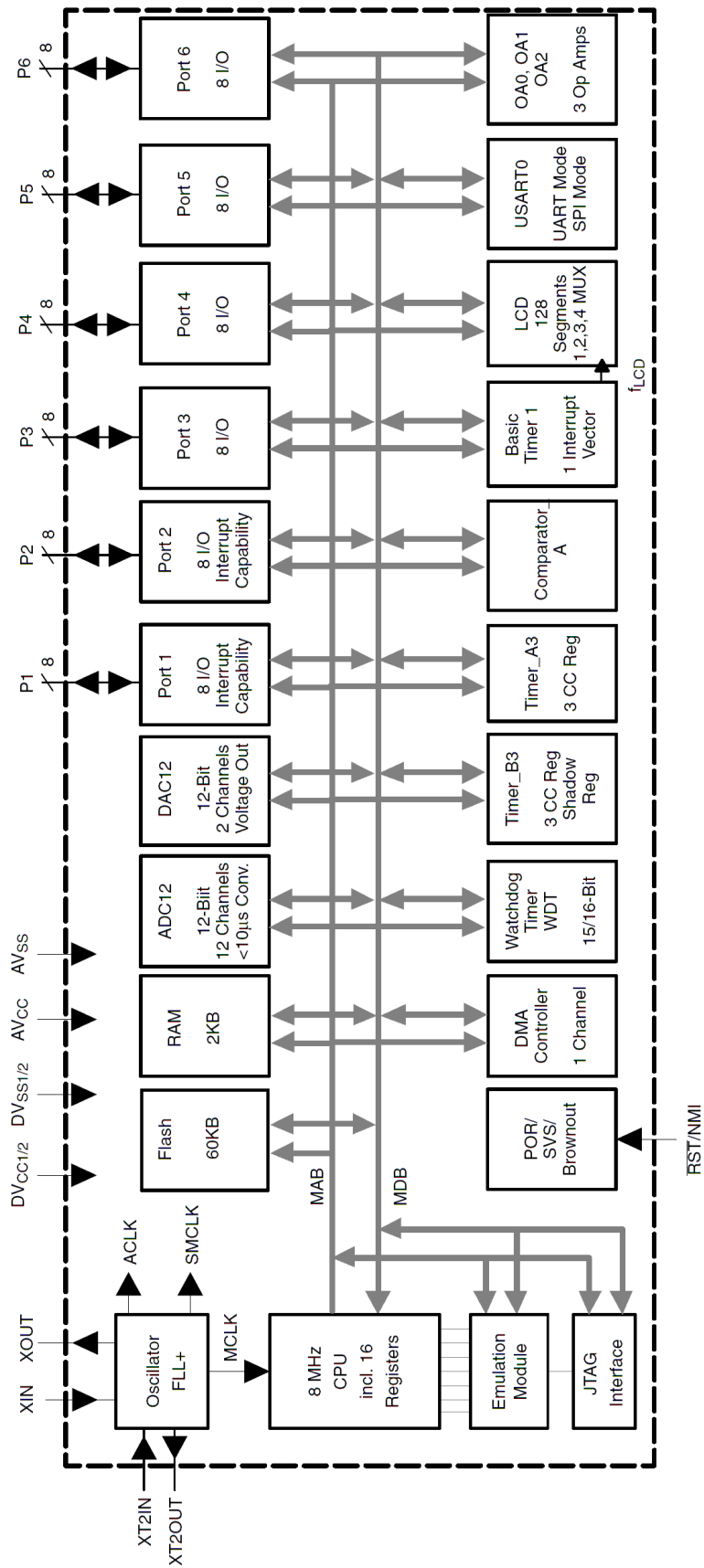

MEMORY ORGANIZATION:

Memory	Size	60KB
Main: interrupt vector	Flash	0FFFFh – 0FFE0h
Main: code memory	Flash	0FFFFh – 01100h
Information memory	Size	256 Byte
	Flash	010FFh – 01000h
Boot memory	Size	1KB
	ROM	0FFFh – 0C00h
RAM	Size	2KB
		09FFh – 0200h
Peripherals	16-bit	01FFh – 0100h
	8-bit	0FFh – 010h
	8-bit SFR	0Fh – 00h

SCHEMATIC:

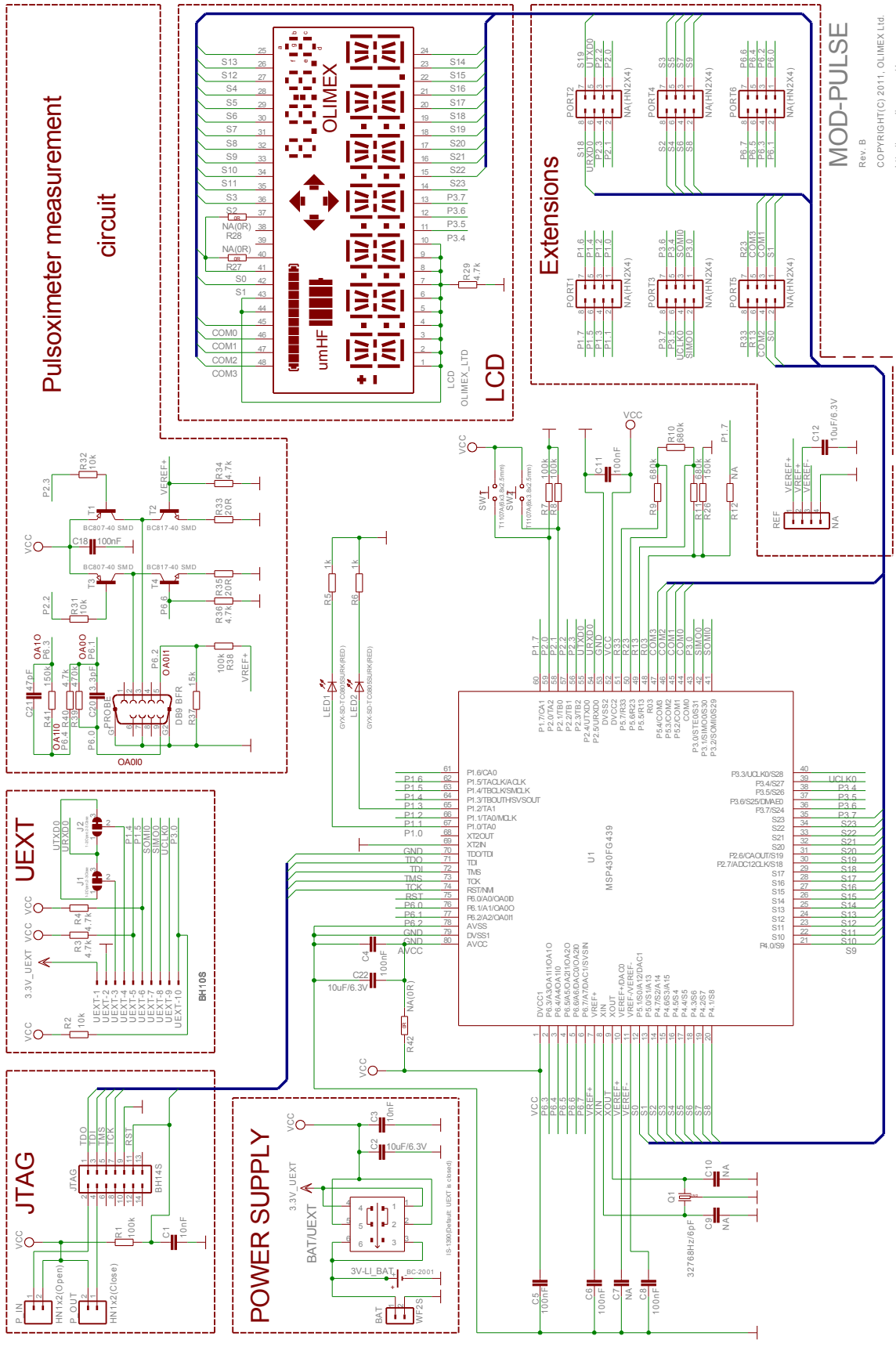

Rev. B
 COPYRIGHT(C) 2011, OLIMEX Ltd.
<http://www.olimex.com/dev>

BOARD LAYOUT:

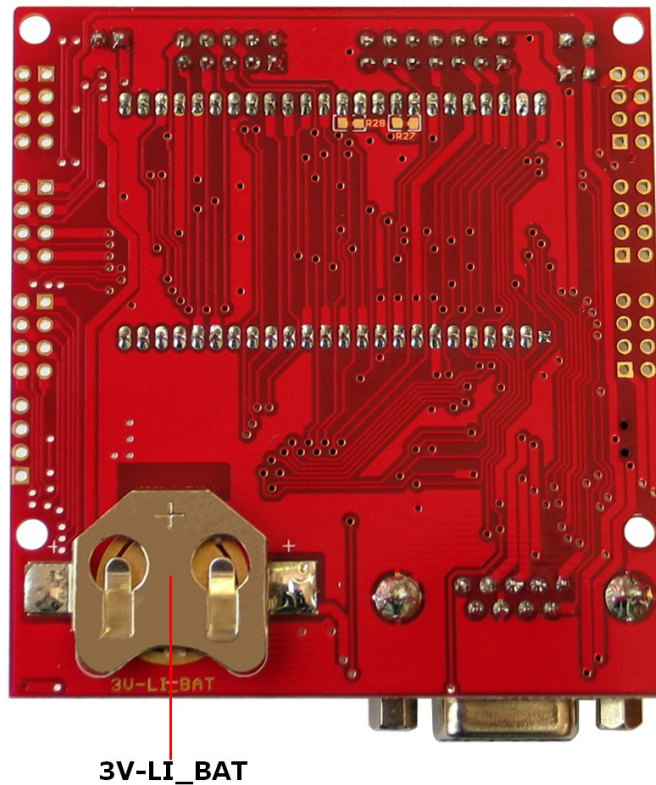
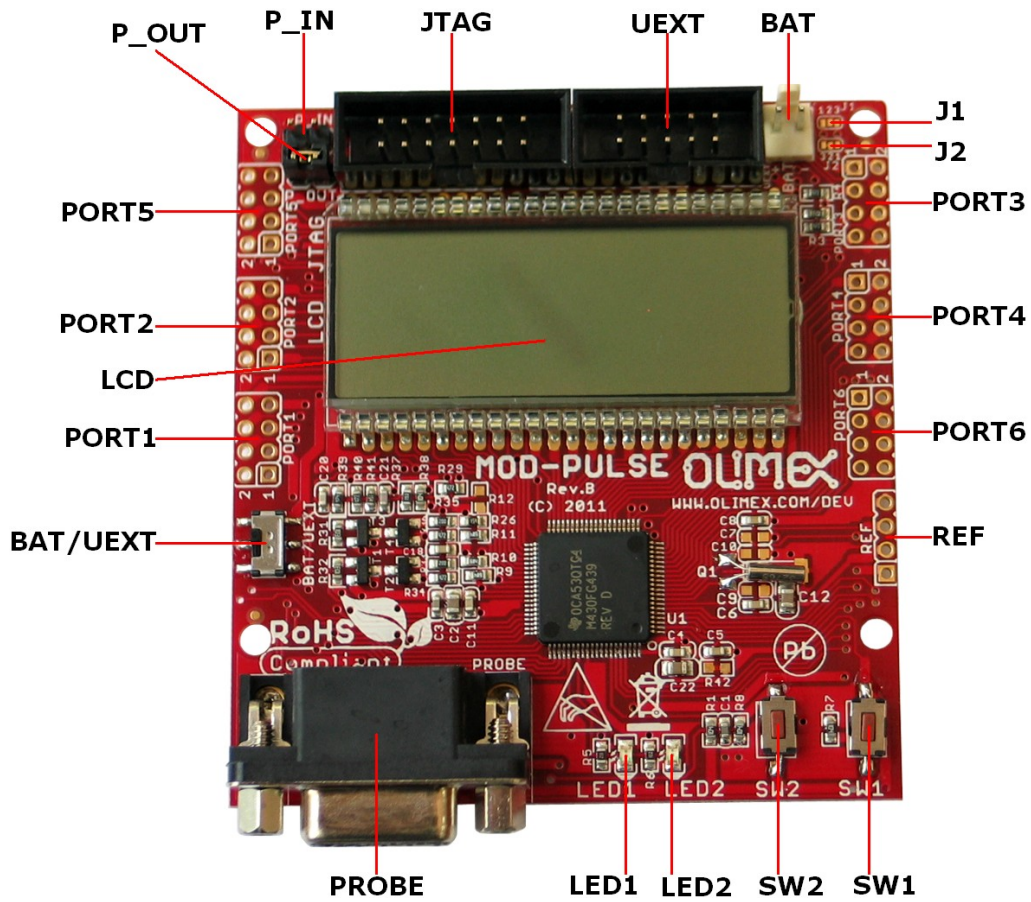

POWER SUPPLY CIRCUIT:

MOD-PULSE can take power from:

-UEXT connector, when BAT/UEXT switch is in position UEXT. In this case the jumper P_OUT has to be closed.

-JTAG, when jumper P_IN is closed.

-+3V via BAT connector, when BAT/UEXT switch is in position BAT. In this case the jumper P_OUT has to be closed.

-+3V lithium battery via 3V-LI_BAT connector, when BAT/UEXT switch is in position BAT. In this case the jumper P_OUT has to be closed.

The programmed board power consumption is about 30 mA with all peripherals enabled. So, we recommend you to supply the board via BAT connector instead of 3V-LI_BAT connector.

RESET CIRCUIT:

MOD-PULSE reset circuit includes R1 (100k), C1 (10nF), JTAG connector pin 11 and MSP43FG439 pin 74 (RST/NMI).

CLOCK CIRCUIT:

Quartz crystal Q1 32.768 kHz is connected to MSP430FG439 pin 8 (XIN) and pin 9 (XOUT).

JUMPER DESCRIPTION:

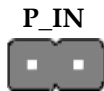

When this jumper is closed, the board is power supplied by the standard JTAG pin 2. This is only possible when the consumption of the board is not very high which is typically the case with MSP430 microcontrollers. If this jumper is open the board should be power supplied by another external source. This jumper and P_OUT should always be reversely open/closed, i.e. if P_IN is closed, P_OUT should be open and vice versa.

Default state is opened.



When this jumper is closed, the board is power supplied not by the JTAG but from external source. Then the JTAG has to synchronize with the working voltages which is done through this line. This is especially important when debugging with JTAG. This jumper and P_IN should always be reversely open/closed, i.e. if P_OUT is closed, P_IN should be open and vice versa.

Default state is closed.

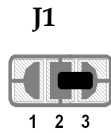

When jumper J1 is shorted in position 1-2, UEXT pin 3 is connected to MSP430FG439 pin 55 (P2.4/UTXD0) – signal “UTXD0”. When jumper J1 is shorted in position 2-3, UEXT pin 3 is connected to MSP430FG439 pin 54 (P2.5/URXD0) – signal “URXD0”.
Default state is shorted in position 2-3.

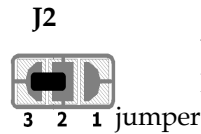

When jumper J2 is shorted in position 1-2, UEXT pin 4 is connected to MSP430FG439 pin 54 (P2.5/URXD0) – signal “URXD0”. When J2 is shorted in position 2-3, UEXT pin 4 is connected to MSP430FG439 pin 55 (P2.4/UTXD0) – signal “UTXD0”.
Default state is shorted in position 2-3.

Depending on jumpers J1 and J2 configuration, the board can work in host, or in device mode. The default state of J1 and J2 is for device mode (shorted in position 2-3).

INPUT/OUTPUT:

Status led with name **LED1 (red)** connected to MSP430FG439 pin 67 (P1.0/TA0).

Status led with name **LED2 (red)** connected to MSP430FG439 pin 65 (P1.2/TA1).

User button with name **SW1** connected to **MSP430FG439** pin 59 (P2.0/TA2).

User button with name **SW2** connected to **MSP430FG439** pin 58 (P2.1/TB0).

Power supply switch with name **BAT/UEXT** – when in position **BAT** – the board is power supplied via +3V lithium battery, when is in position **UEXT** – the board is connected to other board with UEXT and is power supplied by the other board via UEXT connector.

LCD custom display.

EXTERNAL CONNECTORS DESCRIPTION:

UEXT:

Pin #	Signal Name
1	VDD
2	GND
3	TX
4	RX
5	P1.4
6	P1.5
7	SOMI0
8	SIMO0
9	UCLK0
10	P3.0

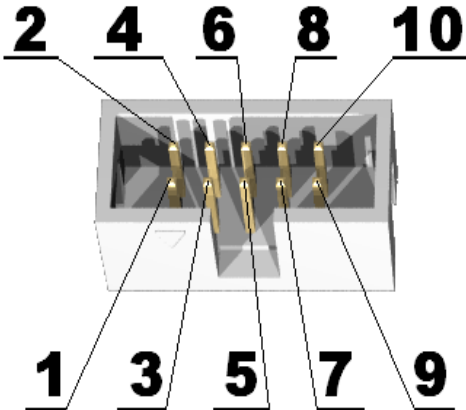

JTAG:

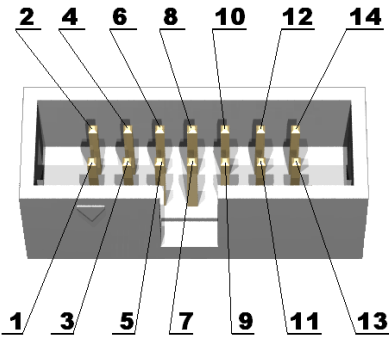

Pin #	Signal Name	Pin #	Signal Name
1	TDO	2	Via P_IN to VCC
3	TDI	4	Via P_OUT to VCC
5	TMS	6	Not Connected
7	TCK	8	Not Connected

9	GND	10	Not Connected
11	RST	12	Not Connected
13	Not Connected	14	Not Connected

PORT1:

Pin #	Signal Name	Pin #	Signal Name
1	P1.0	2	P1.1
3	P1.2	4	P1.3
5	P1.4	6	P1.5
7	P1.6	8	P1.7

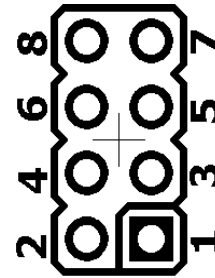

PORT2:

Pin #	Signal Name	Pin #	Signal Name
1	P2.0	2	P2.1
3	P2.2	4	P2.3
5	UTXD0	6	URXD0
7	S19	8	S18

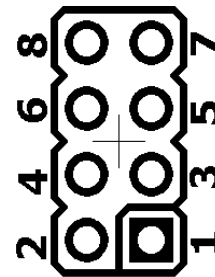

PORT3:

Pin #	Signal Name	Pin #	Signal Name
1	P3.0	2	SIMO0
3	SOMI0	4	UCLK0
5	P3.4	6	P3.5
7	P3.6	8	P3.7

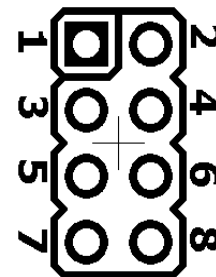

PORT4:

Pin #	Signal Name	Pin #	Signal Name
1	S9	2	S8
3	S7	4	S6
5	S5	6	S4
7	S3	8	S2

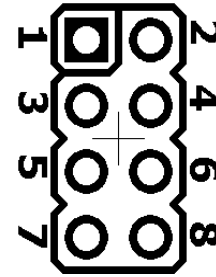

PORT5:

Pin #	Signal Name	Pin #	Signal Name
1	S1	2	S0
3	COM1	4	COM2
5	COM3	6	R13
7	R23	8	R33

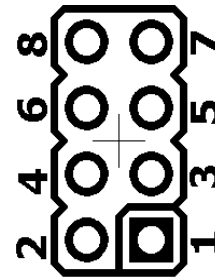

PORT6:

Pin #	Signal Name	Pin #	Signal Name
1	P6.0	2	P6.1
3	P6.2	4	P6.3
5	P6.4	6	P6.5
7	P6.6	8	P6.7

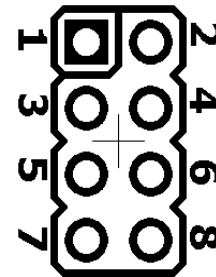

REF:

Pin #	Signal Name	Pin #	Signal Name
1	VEREF+	2	VREF+
3	VEREF-	4	GND



PROBE:

Pin #	Signal Name

1	Not Connected
2	Driving line for sensor's infrared and red led
3	Driving line for sensor's infrared and red led
4	Not Connected
5	P6.2
6	Not Connected
7	GND
8	Not Connected
9	P6.0

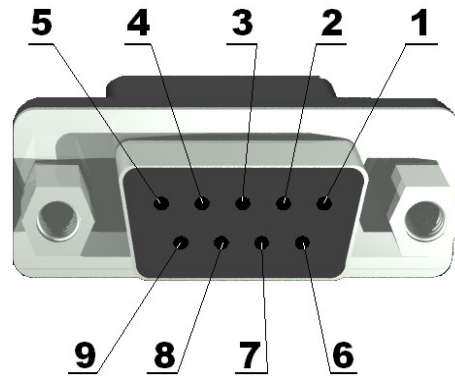

BAT:

Pin #	Signal Name
1	to BAT/UEXT switch
2	GND

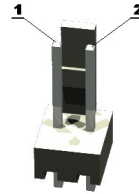

MECHANICAL DIMENSIONS:

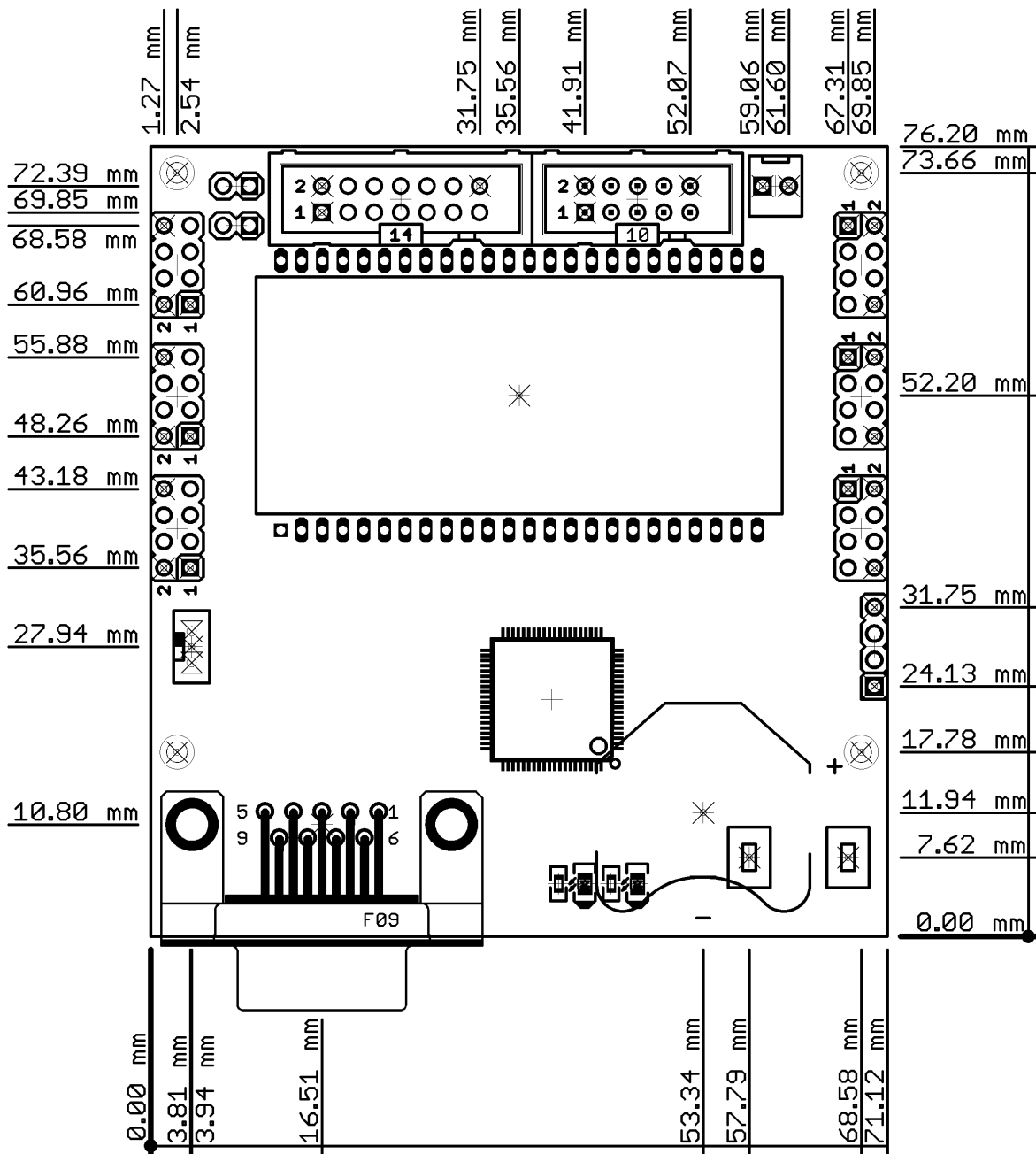

AVAILABLE DEMO SOFTWARE:

Demonstrates blood oxygenation and heart rate measurement. For this demo you must connect sensor to MOD-PULSE's PROBE connector.

-MOD-PULSE_DemoSoft IAR for MSP v4.21

ORDER CODE:

MOD-PULSE - assembled and tested board

How to order?

You can order to us directly or by any of our distributors.
Check our web www.olimex.com/dev for more info.

Revision history:

Board's revision:	Rev. B, June 2011
Manual's revision:	Rev. Initial, June 2011

Disclaimer:

© 2011 Olimex Ltd. All rights reserved. Olimex®, logo and combinations thereof, are registered trademarks of Olimex Ltd. Other terms and product names may be trademarks of others.

The information in this document is provided in connection with Olimex products. No license, express or implied or otherwise, to any intellectual property right is granted by this document or in connection with the sale of Olimex products.

Neither the whole nor any part of the information contained in or the product described in this document may be adapted or reproduced in any material from except with the prior written permission of the copyright holder.

The product described in this document is subject to continuous development and improvements. All particulars of the product and its use contained in this document are given by OLIMEX in good faith. However all warranties implied or expressed including but not limited to implied warranties of merchantability or fitness for purpose are excluded.

This document is intended only to assist the reader in the use of the product. OLIMEX Ltd. shall not be liable for any loss or damage arising from the use of any information in this document or any error or omission in such information or any incorrect use of the product.