



Product Description

RFMD's SBB2089Z is a high performance InGaP HBT MMIC amplifier utilizing a Darlington configuration with an active bias network. The active bias network provides stable current over temperature and process Beta variations. Designed to run directly from a 5V supply, the SBB2089Z does not require a dropping resistor as compared to typical Darlington amplifiers. The SBB2089Z product is designed for high linearity 5V gain block applications that require small size and minimal external components. It is internally matched to 50Ω.

Optimum Technology Matching® Applied

- GaAs HBT
- GaAs MESFET
- InGaP HBT
- SiGe BiCMOS
- Si BiCMOS
- SiGe HBT
- GaAs pHEMT
- Si CMOS
- Si BJT
- GaN HEMT
- InP HBT
- RF MEMS
- LDMOS

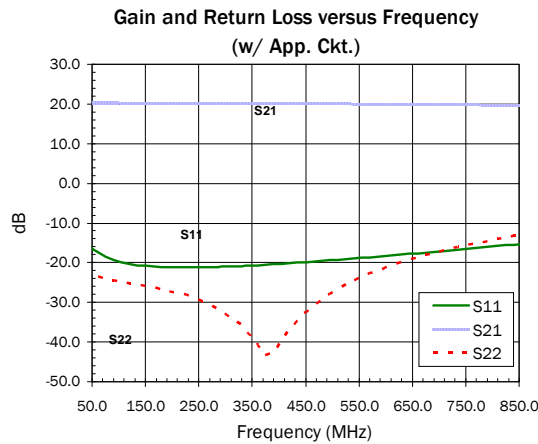

Features

- OIP₃=42.8dBm at 240MHz
- P_{1dB}=20.8dBm at 500MHz
- Single Fixed 5V Supply
- Robust 2000V ESD, Class 2
- Patented Thermal Design and Bias Circuit
- Low Thermal Resistance

Applications

- Receiver IF Amplifier
- Cellular, PCS, GSM, UMTS
- Wireless Data, Satellite Terminals

Parameter	Specification			Unit	Condition
	Min.	Typ.	Max.		
Small Signal Gain		20.0		dB	70MHz
	18.5	20.0	21.5	dB	240MHz
	18.5	20.0	21.5	dB	400MHz
Output Power at 1dB Compression		20.0		dBm	70MHz
		20.0		dBm	240MHz
	18.5	21.0		dBm	400MHz
Third Order Intercept Point		41.0		dBm	70MHz
		43.0		dBm	240MHz
	39.0	41.0		dBm	400MHz
Return Loss		50 to 850		MHz	Minimum 10dB
Input Return Loss	15.0	20.0		dB	70MHz to 5000MHz
Output Return Loss	11.0	14.0		dB	70MHz to 5000MHz
Noise Figure		2.7	3.7	dB	500MHz
Reverse Isolation		22.0		dB	70MHz to 5000MHz
Thermal Resistance		48.8		°C/W	junction - lead
Device Operating Voltage		5.0	5.3	V	
Device Operating Current	82.0	90.0	98.0	mA	

Test Conditions: V_D=5V, I_D=90mA Typ., OIP₃ Tone Spacing=1MHz, P_{OUT} per tone=0dBm, T_L=25°C, Z_S=Z_L=50Ω, Tested with Bias Tees

Absolute Maximum Ratings

Parameter	Rating	Unit
Device Current (I_D)	110	mA
Device Voltage (V_D)	5.5	V
RF Input Power	24	dBm
Junction Temp (T_J)	+150	°C
Operating Temp Range (T_L)	-40 to +85	°C
Storage Temp	+150	°C
Power Dissipation	0.61	W
ESD Rating - Human Body Model (HBM)	Class 2	
Moisture Sensitivity Level	MSL2	



Caution! ESD sensitive device.

Exceeding any one or a combination of the Absolute Maximum Rating conditions may cause permanent damage to the device. Extended application of Absolute Maximum Rating conditions to the device may reduce device reliability. Specified typical performance or functional operation of the device under Absolute Maximum Rating conditions is not implied.

RoHS status based on EU Directive 2002/95/EC (at time of this document revision).

The information in this publication is believed to be accurate and reliable. However, no responsibility is assumed by RF Micro Devices, Inc. ("RFMD") for its use, nor for any infringement of patents, or other rights of third parties, resulting from its use. No license is granted by implication or otherwise under any patent or patent rights of RFMD. RFMD reserves the right to change component circuitry, recommended application circuitry and specifications at any time without prior notice.

Operation of this device beyond any one of these limits may cause permanent damage. For reliable continuous operation, the device voltage and current must not exceed the maximum operating values specified in the table on page one.

Bias Conditions should also satisfy the following expression:

$$I_D V_D < (T_J - T_L) / R_{TH, j-l} \text{ and } T_L = T_{LEAD}$$

Typical RF Performance at Key Operating Frequencies (With Application Circuit)

Parameter	Unit	50MHz	70MHz	100 MHz	240 MHz	400 MHz	500 MHz	850 MHz
Small Signal Gain, S_{21}	dB	20.0	20.0	20.0	20.0	20.0	20.0	20.0
Output Third Order Intercept Point, OIP_3	dBm	40.0	40.0	41.0	42.0	41.0	40.0	35.0
Output Power at 1dB Compression, P_{1dB}	dBm	20.0	20.0	20.0	20.0	20.0	20.0	19.0
Input Return Loss, IRL	dB	15.0	18.0	19.0	20.0	20.0	19.0	16.0
Output Return Loss, ORL	dB	21.0	23.0	24.0	27.0	34.0	30.0	14.0
Reverse Isolation, S_{12}	dB	22.0	22.0	22.0	22.0	22.0	22.0	22.0
Noise Figure, NF	dB	3.1	2.9	2.7	2.6	2.7	2.8	2.9

Test Conditions: $V_{CC}=5V$ $I_D=90mA$ Typ. OIP_3 Tone Spacing=1MHz, P_{OUT} per tone=0dBm $T_L=25^\circ C$ $Z_S=Z_L=50\Omega$

Data on charts taken with Application Circuit

Noise Figure versus Frequency

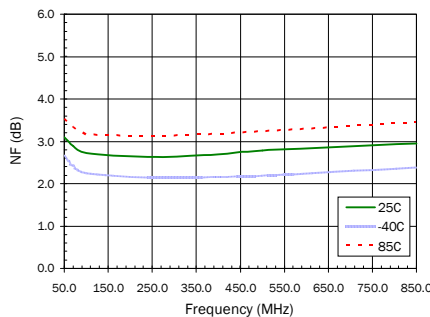

P_{1dB} versus Frequency

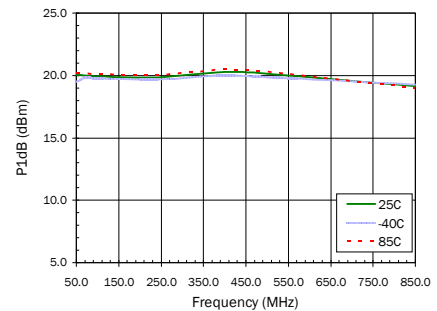

OIP_3 versus Frequency

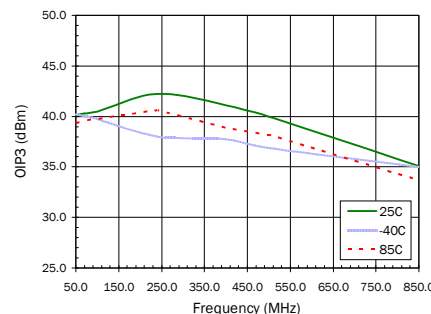

Application Circuit S-Parameters Over Temperature

S11 versus Frequency

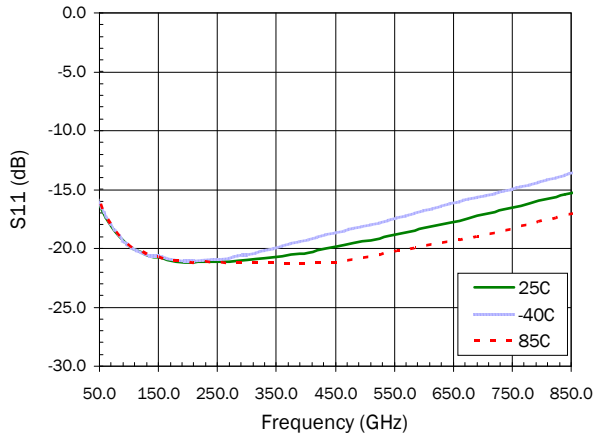

S21 versus Frequency

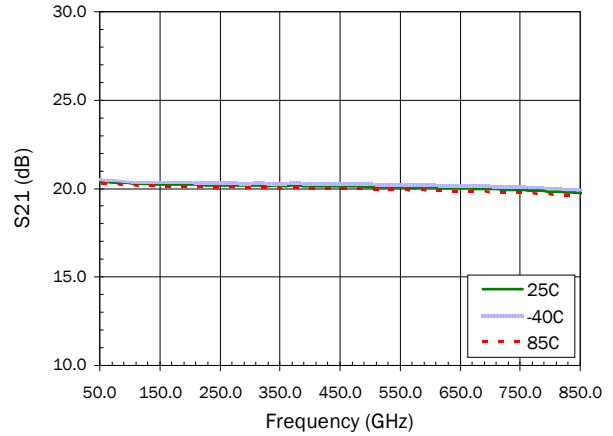

S12 versus Frequency

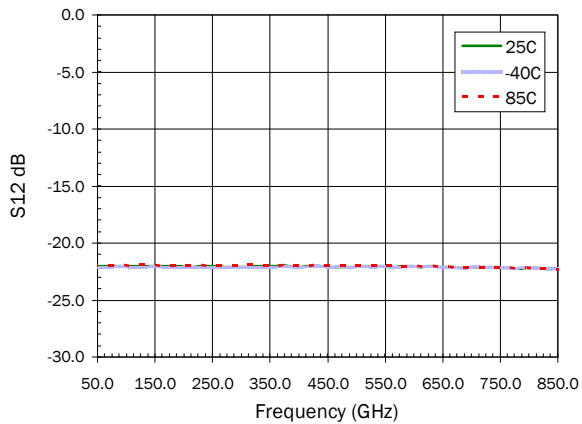

S22 versus Frequency

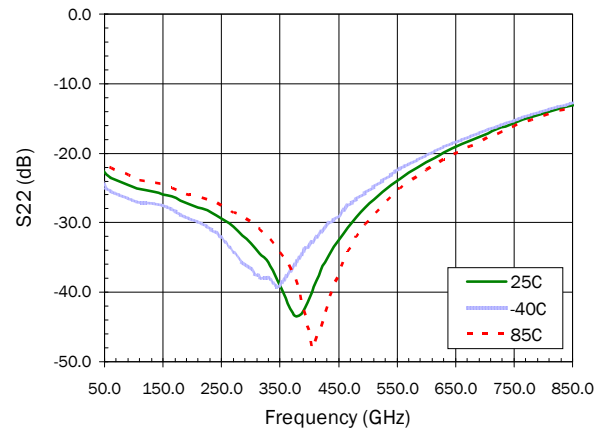

Device Current Over Temperature with Application Circuit

**Current versus Voltage Over Temperature
Application Circuit**

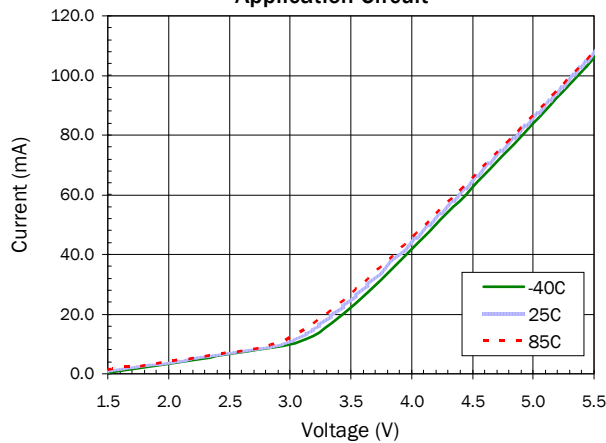

S-Parameters Over Temperature (Bias Tee) S11 versus Frequency

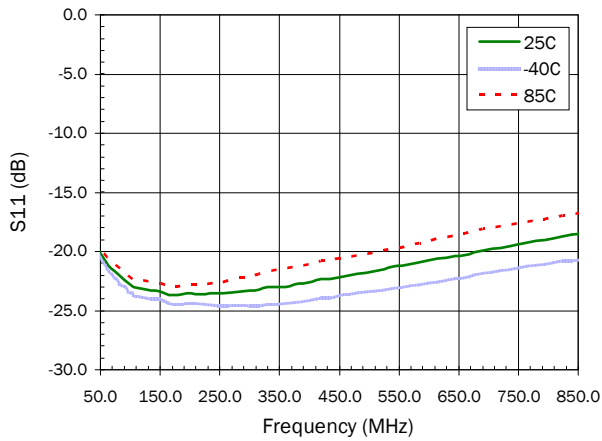

S21 versus Frequency

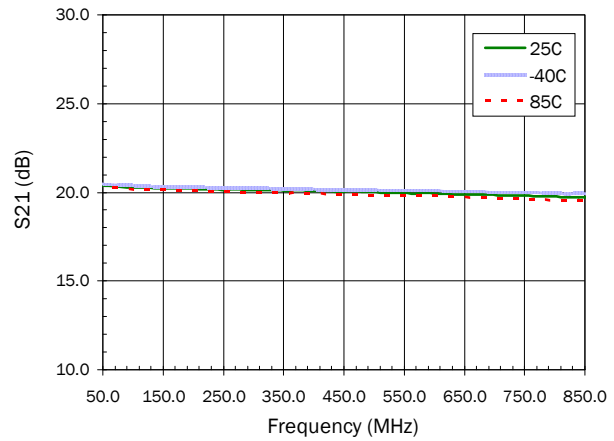

S12 versus Frequency

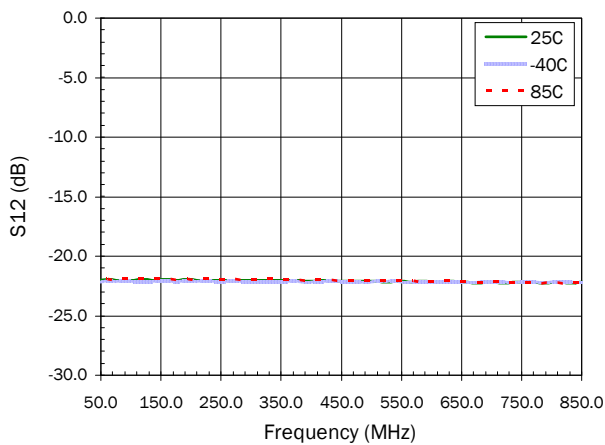

S22 versus Frequency

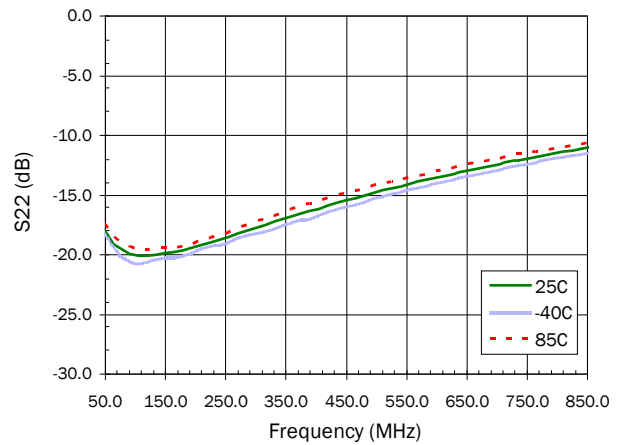

Device Current Over Temperature with Application Circuit

Current versus Voltage Over Temperature Application Circuit

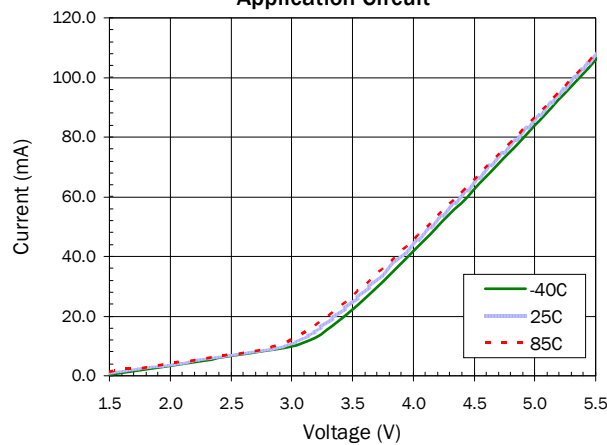

Pin	Function	Description
1	RF IN	RF input pin. This pin requires the use of an external DC blocking capacitor chosen for the frequency of operation.
2, 4	GND	Connection to ground. Use via holes for best performance to reduce lead inductance as close to ground leads as possible.
3	RF OUT/BIAS	RF output and bias pin. DC voltage is present on this pin, therefore a DC blocking capacitor is necessary for proper operation.

Suggested PCB Pad Layout

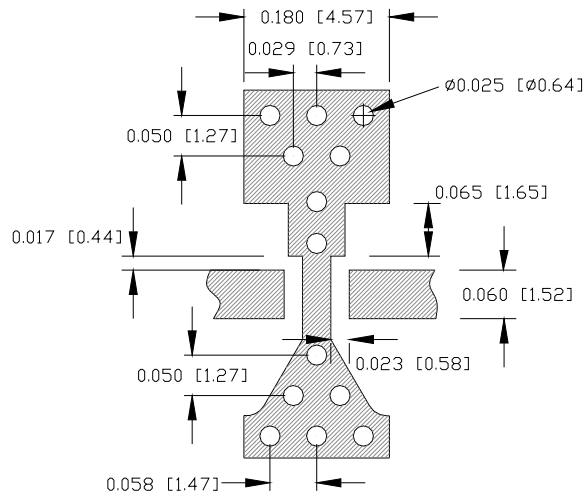

Package Drawing

Dimensions in inches (millimeters)
 Refer to drawing posted at www.rfmd.com for tolerances.

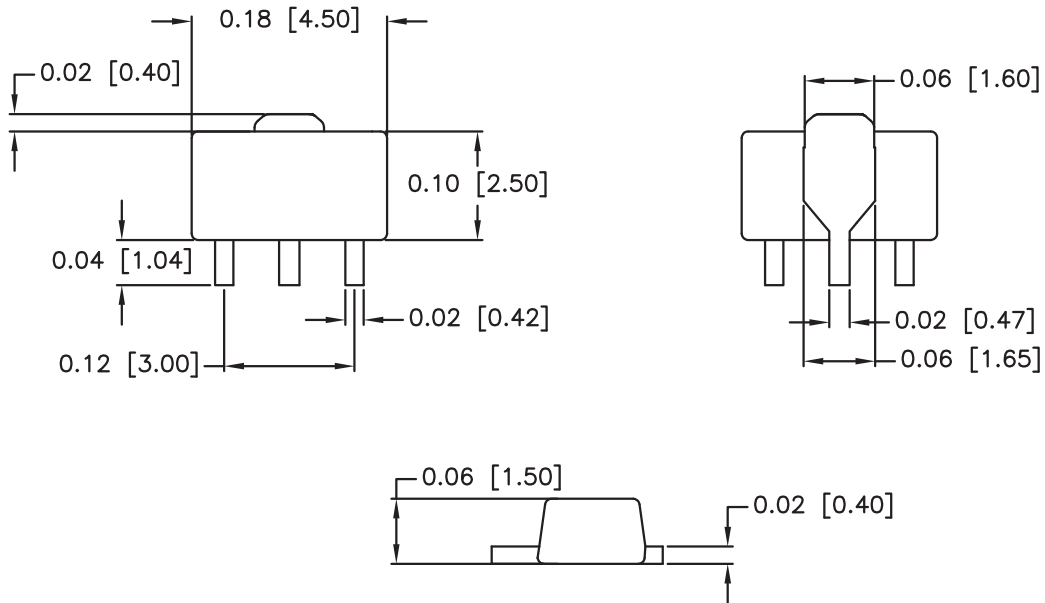

Application Circuit Element Values

Reference Designator	Frequency (MHz) 50 to 850
CB	8200 pF
LC	1500 nH 0805LS Coilcraft
LS	2.7 nH Toko

Application Schematic

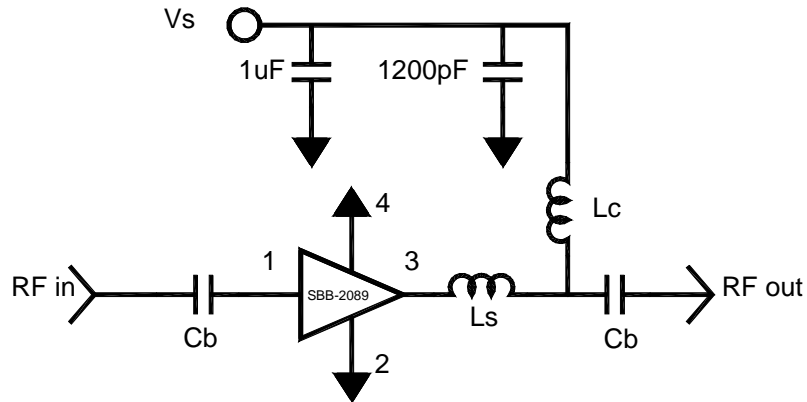

Evaluation Board Layout

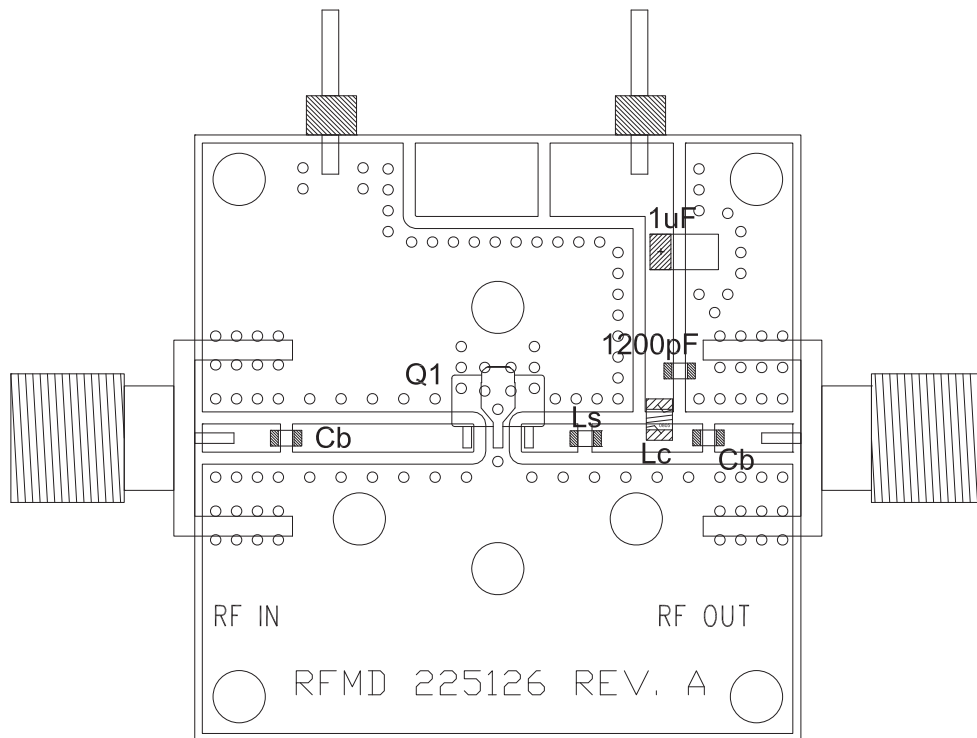

Package Marking

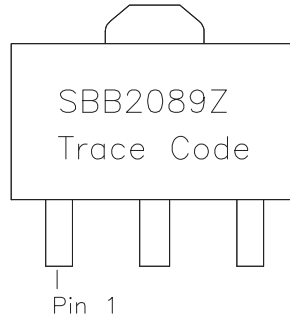

Ordering Information

Ordering Code	Description
SBB2089Z	7" Reel with 1000 pieces
SBB2089ZSQ	Sample bag with 25 pieces
SBB2089ZSR	7" Reel with 100 pieces
SBB2089ZPCK1	50MHz to 850MHz PCBA with 5-piece sample bag