

# IRF9910PbF

HEXFET® Power MOSFET

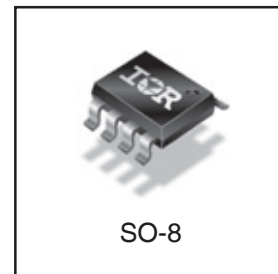
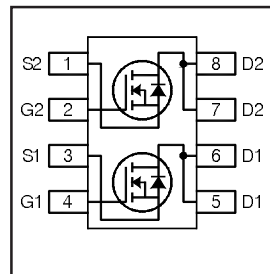
## Applications

- Dual SO-8 MOSFET for POL converters in desktop, servers, graphics cards, game consoles and set-top box
- Lead-Free

$V_{DSS}$	$R_{DS(on)}$ max	$I_D$
20V	Q1 13.4m $\Omega$ @ $V_{GS} = 10V$	10A
	Q2 9.3m $\Omega$ @ $V_{GS} = 10V$	12A

## Benefits

- Very Low  $R_{DS(on)}$  at 4.5V  $V_{GS}$
- Low Gate Charge
- Fully Characterized Avalanche Voltage and Current
- 20V  $V_{GS}$  Max. Gate Rating



## Absolute Maximum Ratings

	Parameter	Q1 Max.	Q2 Max.	Units
$V_{DS}$	Drain-to-Source Voltage	20		V
$V_{GS}$	Gate-to-Source Voltage	$\pm 20$		
$I_D @ T_A = 25^\circ C$	Continuous Drain Current, $V_{GS} @ 10V$	10	12	A
$I_D @ T_A = 70^\circ C$	Continuous Drain Current, $V_{GS} @ 10V$	8.3	9.9	
$I_{DM}$	Pulsed Drain Current ①	83	98	
$P_D @ T_A = 25^\circ C$	Power Dissipation	2.0		W
$P_D @ T_A = 70^\circ C$	Power Dissipation	1.3		
	Linear Derating Factor	0.016		W/ $^\circ C$
$T_J$	Operating Junction and	-55 to + 150		$^\circ C$
$T_{STG}$	Storage Temperature Range			

## Thermal Resistance

	Parameter	Typ.	Max.	Units
$R_{\theta JL}$	Junction-to-Drain Lead	—	42	$^\circ C/W$
$R_{\theta JA}$	Junction-to-Ambient ④⑤	—	62.5	

Notes ① through ⑤ are on page 10

www.irf.com

1

07/23/08

# IRF9910PbF

International  
IR Rectifier

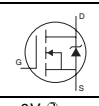
Static @ T<sub>J</sub> = 25°C (unless otherwise specified)

	Parameter		Min.	Typ.	Max.	Units	Conditions		
BV <sub>DSS</sub>	Drain-to-Source Breakdown Voltage	Q1&Q2	20	---	---	V	V <sub>GS</sub> = 0V, I <sub>D</sub> = 250μA		
ΔBV <sub>DSS</sub> /ΔT <sub>J</sub>	Breakdown Voltage Temp. Coefficient	Q1	---	0.0061	---	V/°C	Reference to 25°C, I <sub>D</sub> = 1mA		
		Q2	---	0.014	---				
R <sub>DS(on)</sub>	Static Drain-to-Source On-Resistance	Q1	---	10.7	13.4	mΩ	V <sub>GS</sub> = 10V, I <sub>D</sub> = 10A ③		
			---	14.6	18.3		V <sub>GS</sub> = 4.5V, I <sub>D</sub> = 8.3A ③		
		Q2	---	7.4	9.3		V <sub>GS</sub> = 10V, I <sub>D</sub> = 12A ③		
			---	9.1	11.3		V <sub>GS</sub> = 4.5V, I <sub>D</sub> = 9.8A ③		
V <sub>GS(th)</sub>	Gate Threshold Voltage	Q1&Q2	1.65	---	2.55	V	V <sub>DS</sub> = V <sub>GS</sub> , I <sub>D</sub> = 250μA		
ΔV <sub>GS(th)</sub> /ΔT <sub>J</sub>	Gate Threshold Voltage Coefficient	Q1	---	-4.9	---	mV/°C			
		Q2	---	-5.0	---				
I <sub>DSS</sub>	Drain-to-Source Leakage Current	Q1&Q2	---	---	1.0	μA	V <sub>DS</sub> = 16V, V <sub>GS</sub> = 0V		
		Q1&Q2	---	---	100		V <sub>DS</sub> = 16V, V <sub>GS</sub> = 0V, T <sub>J</sub> = 125°C		
I <sub>GSS</sub>	Gate-to-Source Forward Leakage	Q1&Q2	---	---	100	nA	V <sub>GS</sub> = 20V		
	Gate-to-Source Reverse Leakage	Q1&Q2	---	---	-100		V <sub>GS</sub> = -20V		
g <sub>fs</sub>	Forward Transconductance	Q1	19	---	---	S	V <sub>DS</sub> = 10V, I <sub>D</sub> = 8.3A		
		Q2	27	---	---		V <sub>DS</sub> = 10V, I <sub>D</sub> = 9.8A		
Q <sub>g</sub>	Total Gate Charge	Q1	---	7.4	11	nC	Q1 V <sub>DS</sub> = 10V V <sub>GS</sub> = 4.5V, I <sub>D</sub> = 8.3A  Q2 V <sub>DS</sub> = 10V V <sub>GS</sub> = 4.5V, I <sub>D</sub> = 9.8A		
		Q2	---	15	23				
Q <sub>gs1</sub>	Pre-V <sub>th</sub> Gate-to-Source Charge	Q1	---	2.6	---				
		Q2	---	4.3	---				
Q <sub>gs2</sub>	Post-V <sub>th</sub> Gate-to-Source Charge	Q1	---	0.85	---				
		Q2	---	1.4	---				
Q <sub>gd</sub>	Gate-to-Drain Charge	Q1	---	2.5	---				
		Q2	---	5.4	---				
Q <sub>qodr</sub>	Gate Charge Overdrive	Q1	---	1.5	---				
		Q2	---	3.9	---				
Q <sub>sw</sub>	Switch Charge (Q <sub>gs2</sub> + Q <sub>gd</sub> )	Q1	---	3.4	---				
		Q2	---	6.8	---				
Q <sub>oss</sub>	Output Charge	Q1	---	4.0	---			nC	V <sub>DS</sub> = 10V, V <sub>GS</sub> = 0V
		Q2	---	8.7	---				
t <sub>d(on)</sub>	Turn-On Delay Time	Q1	---	6.3	---	ns	Q1 V <sub>DD</sub> = 16V, V <sub>GS</sub> = 4.5V I <sub>D</sub> = 8.3A  Q2 V <sub>DD</sub> = 16V, V <sub>GS</sub> = 4.5V I <sub>D</sub> = 9.8A Clamped Inductive Load		
		Q2	---	8.3	---				
t <sub>r</sub>	Rise Time	Q1	---	10	---				
		Q2	---	14	---				
t <sub>d(off)</sub>	Turn-Off Delay Time	Q1	---	9.2	---				
		Q2	---	15	---				
t <sub>f</sub>	Fall Time	Q1	---	4.5	---				
		Q2	---	7.5	---				
C <sub>iss</sub>	Input Capacitance	Q1	---	900	---			pF	V <sub>GS</sub> = 0V V <sub>DS</sub> = 10V f = 1.0MHz
		Q2	---	1860	---				
C <sub>oss</sub>	Output Capacitance	Q1	---	290	---				
		Q2	---	600	---				
C <sub>rss</sub>	Reverse Transfer Capacitance	Q1	---	140	---				
		Q2	---	310	---				

## Avalanche Characteristics

	Parameter	Typ.	Q1 Max.	Q2 Max.	Units
E <sub>AS</sub>	Single Pulse Avalanche Energy ②	---	33	26	mJ
I <sub>AR</sub>	Avalanche Current ①	---	8.3	9.8	A

## Diode Characteristics

	Parameter		Min.	Typ.	Max.	Units	Conditions
I <sub>S</sub>	Continuous Source Current (Body Diode)	Q1&Q2	---	---	2.5	A	MOSFET symbol showing the integral reverse p-n junction diode. 
I <sub>SM</sub>	Pulsed Source Current (Body Diode) ①	Q1	---	---	83	A	
		Q2	---	---	98		
V <sub>SD</sub>	Diode Forward Voltage	Q1	---	---	1.0	V	T <sub>J</sub> = 25°C, I <sub>S</sub> = 8.3A, V <sub>GS</sub> = 0V ③
		Q2	---	---	1.0		T <sub>J</sub> = 25°C, I <sub>S</sub> = 9.8A, V <sub>GS</sub> = 0V ③
t <sub>rr</sub>	Reverse Recovery Time	Q1	---	11	17	ns	Q1 T <sub>J</sub> = 25°C, I <sub>F</sub> = 8.3A, V <sub>DD</sub> = 10V, di/dt = 100A/μs ③
		Q2	---	16	24		
Q <sub>rr</sub>	Reverse Recovery Charge	Q1	---	3.1	4.7	nC	Q2 T <sub>J</sub> = 25°C, I <sub>F</sub> = 9.8A, V <sub>DD</sub> = 10V, di/dt = 100A/μs ③
		Q2	---	4.9	7.3		

Q1 - Control FET

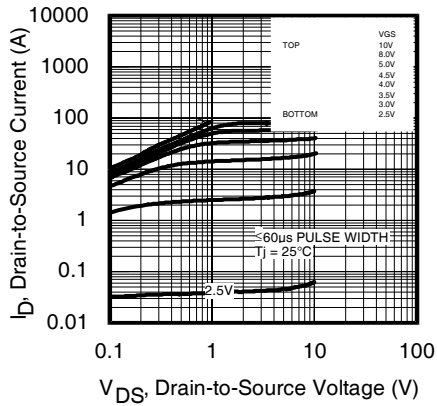


Fig 1. Typical Output Characteristics

Q2 - Synchronous FET

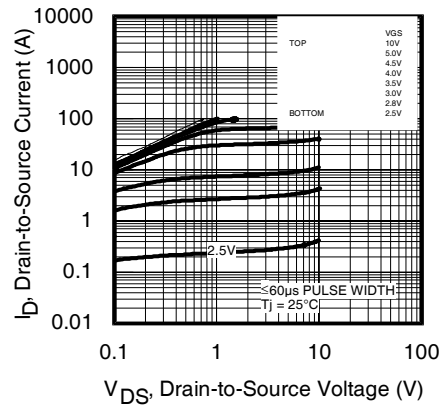


Fig 2. Typical Output Characteristics

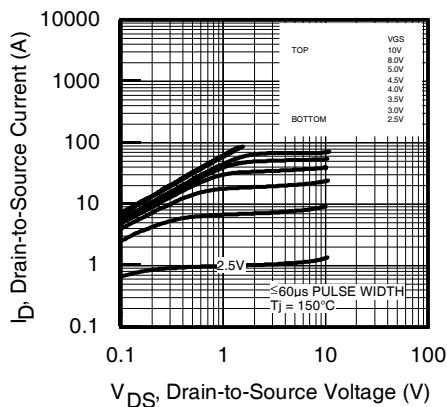


Fig 3. Typical Output Characteristics

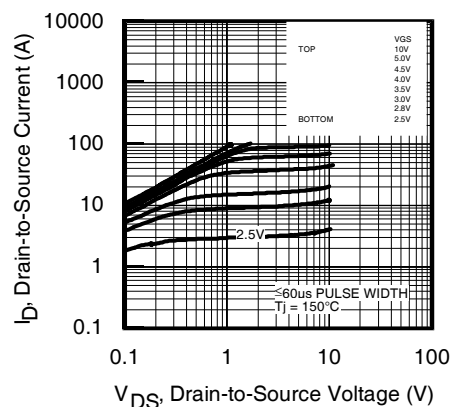


Fig 4. Typical Output Characteristics

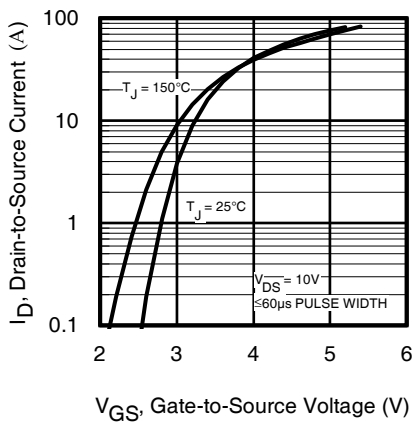


Fig 5. Typical Transfer Characteristics

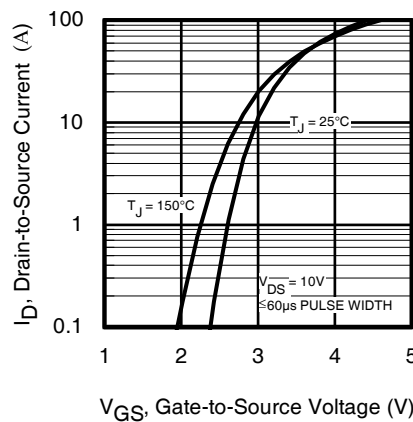


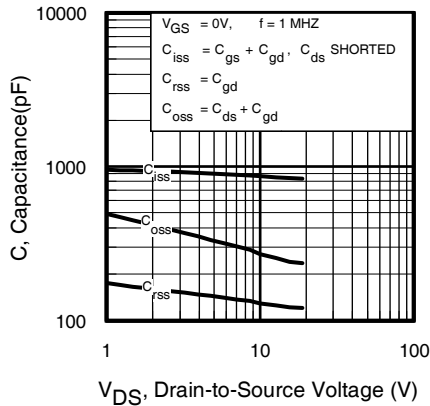
Fig 6. Typical Transfer Characteristics

# IRF9910PbF

## Typical Characteristics

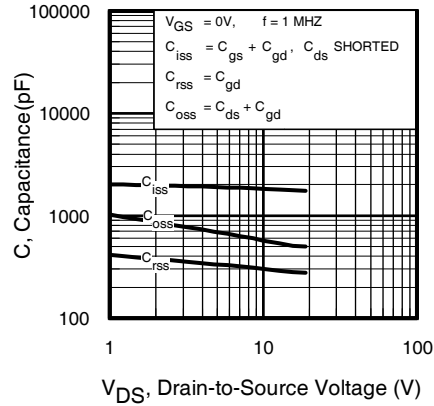


**Q1 - Control FET**

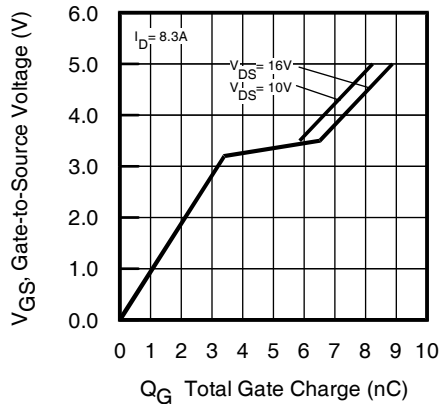


**Fig 7.** Typical Capacitance Vs.Drain-to-Source Voltage

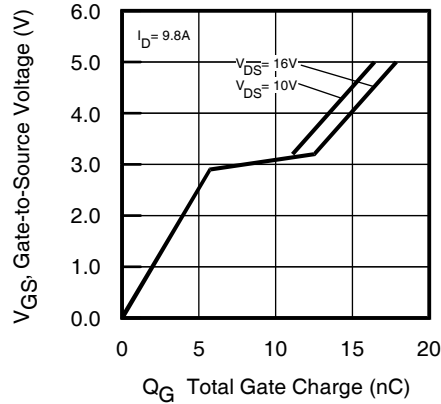
**Q2 - Synchronous FET**



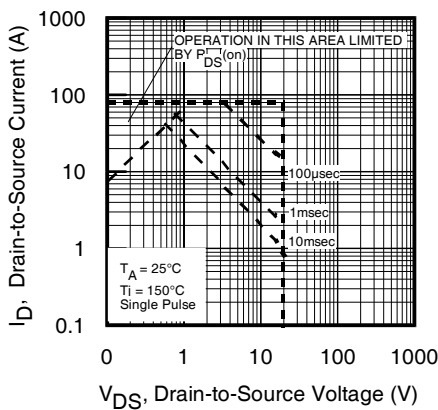
**Fig 8.** Typical Capacitance Vs.Drain-to-Source Voltage



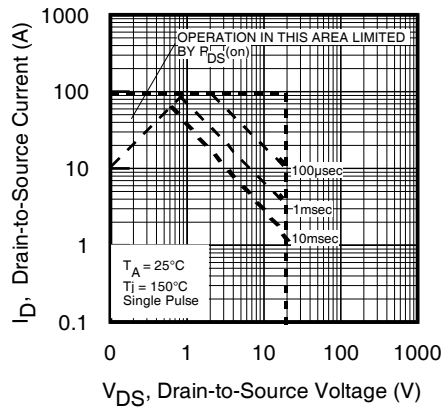
**Fig. 9.** Gate-to-Source Voltage vs Typical Gate Charge



**Fig. 10.** Gate-to-Source Voltage vs Typical Gate Charge



**Fig 11.** Maximum Safe Operating Area



**Fig 12.** Maximum Safe Operating Area

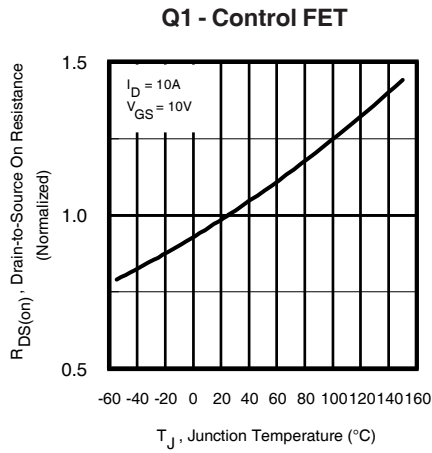


Fig 13. Normalized On-Resistance vs. Temperature

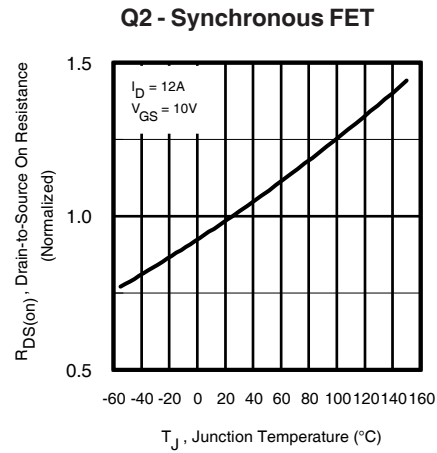


Fig 14. Normalized On-Resistance vs. Temperature

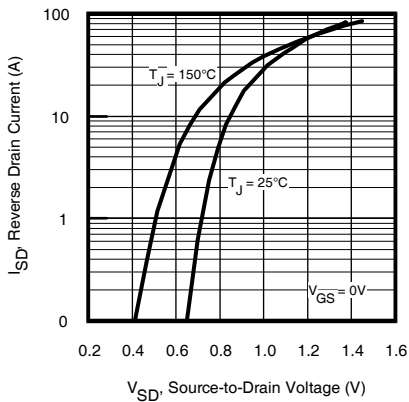


Fig 15. Typical Source-Drain Diode Forward Voltage

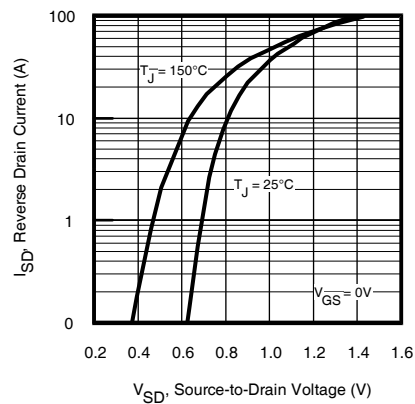


Fig 16. Typical Source-Drain Diode Forward Voltage

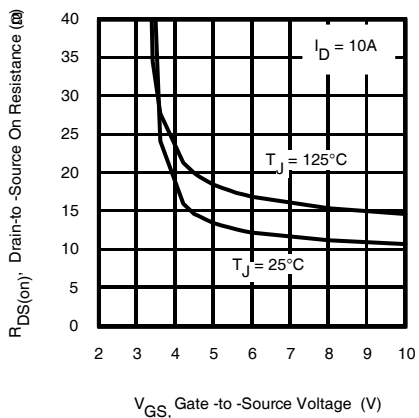


Fig 17. Typical On-Resistance vs. Gate Voltage

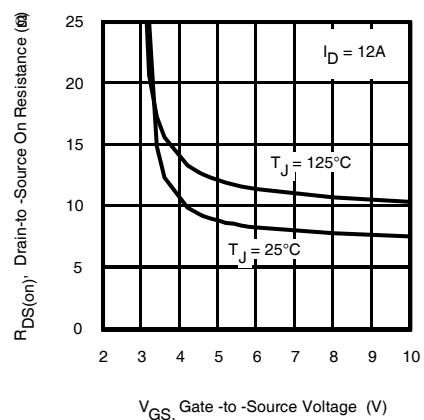
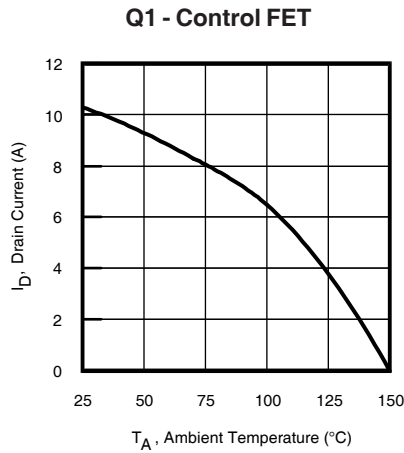
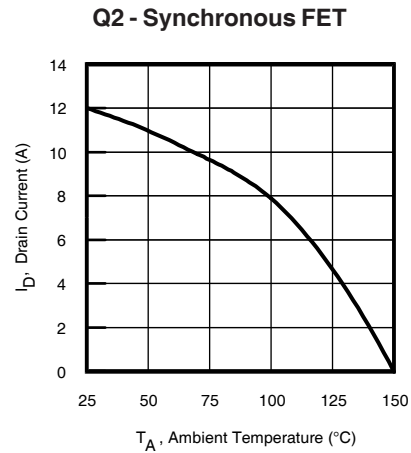


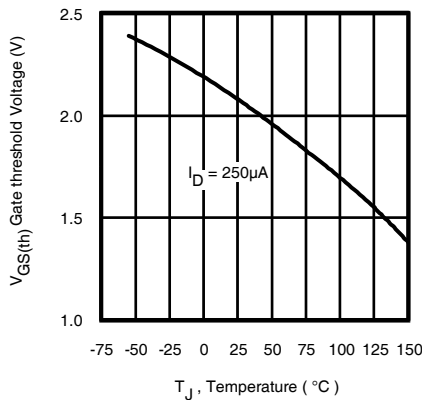
Fig 18. Typical On-Resistance vs. Gate Voltage



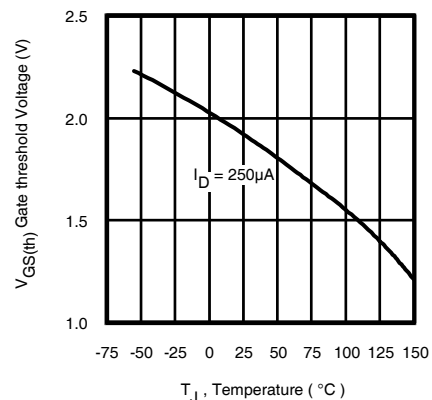
**Fig 19.** Maximum Drain Current vs. Ambient Temperature



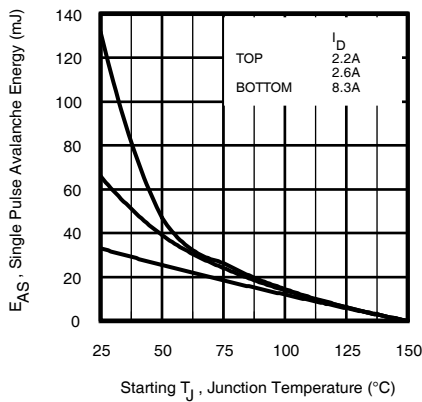
**Fig 20.** Maximum Drain Current vs. Ambient Temperature



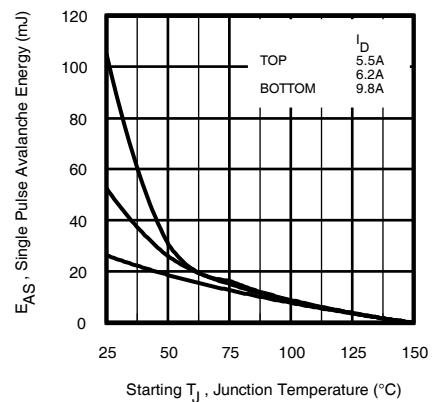
**Fig 21.** Threshold Voltage vs. Temperature



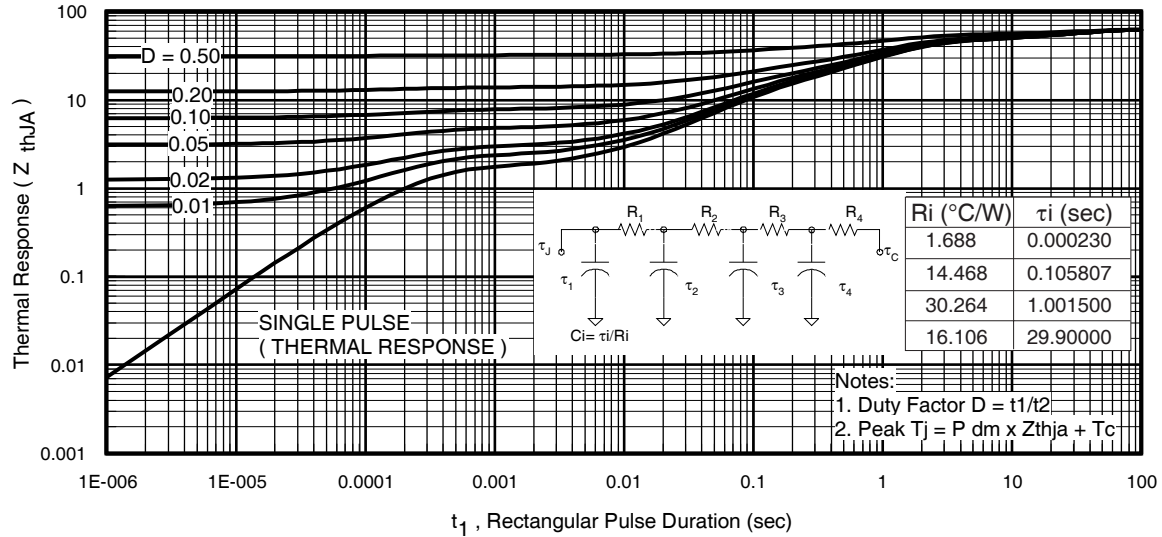
**Fig 22.** Threshold Voltage vs. Temperature



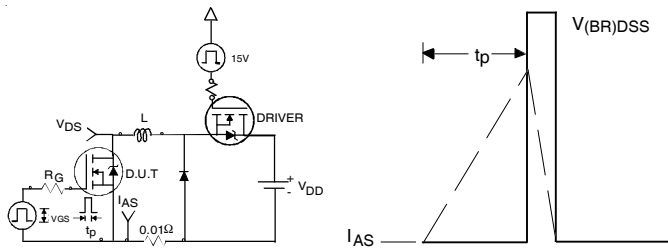
**Fig 23.** Maximum Avalanche Energy vs. Drain Current



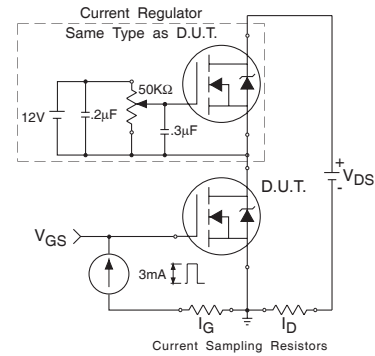
**Fig 24.** Maximum Avalanche Energy vs. Drain Current



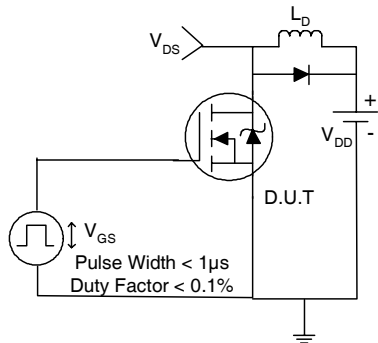
**Fig 25.** Maximum Effective Transient Thermal Impedance, Junction-to-Ambient



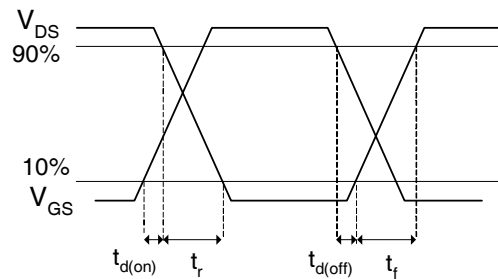
**Fig 26.** Unclamped Inductive Test Circuit and Waveform



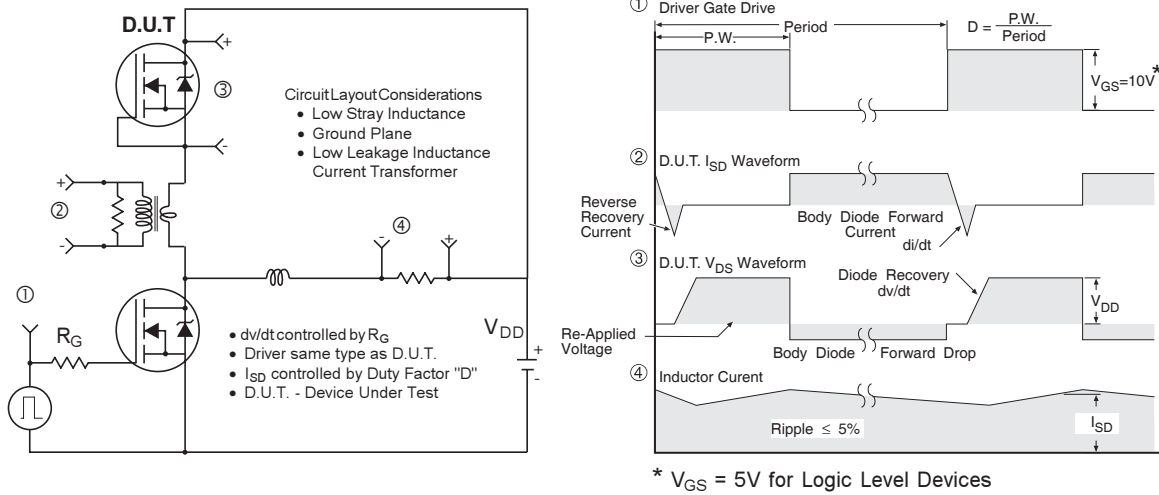
**Fig 27.** Gate Charge Test Circuit



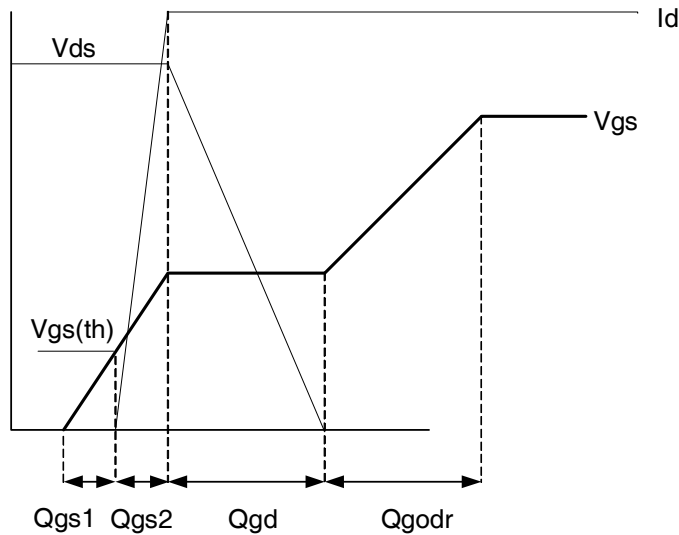
**Fig 28.** Switching Time Test Circuit



**Fig 29.** Switching Time Waveforms



**Fig 30. Peak Diode Recovery  $dv/dt$  Test Circuit for N-Channel HEXFET® Power MOSFETs**

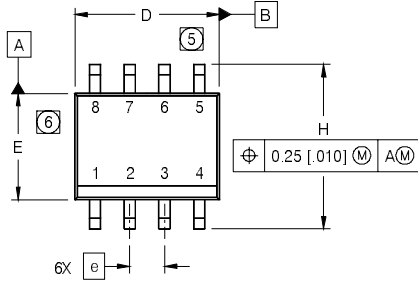


**Fig 31. Gate Charge Waveform**

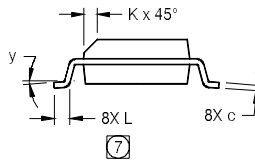
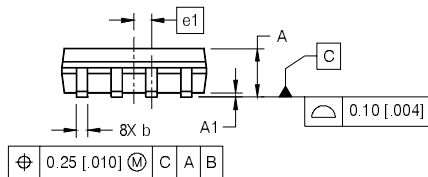


## SO-8 Package Outline (MOSFET & Fetky)

Dimensions are shown in millimeters (inches)



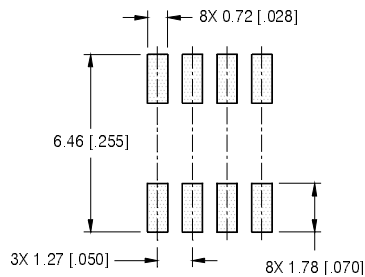
DIM	INCHES		MILLIMETERS	
	MIN	MAX	MIN	MAX
A	.0532	.0688	1.35	1.75
A1	.0040	.0098	0.10	0.25
b	.013	.020	0.33	0.51
c	.0075	.0098	0.19	0.25
D	.189	.1968	4.80	5.00
E	.1497	.1574	3.80	4.00
e	.050 BASIC		1.27 BASIC	
e1	.025 BASIC		0.635 BASIC	
H	.2284	.2440	5.80	6.20
K	.0099	.0196	0.25	0.50
L	.016	.050	0.40	1.27
y	0°	8°	0°	8°



**NOTES:**

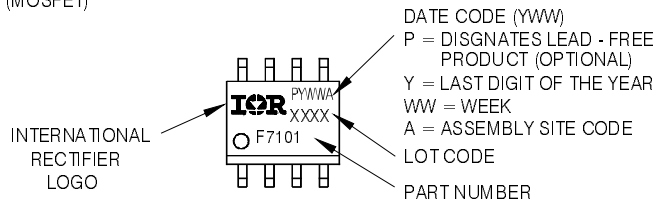
1. DIMENSIONING & TOLERANCING PER ASME Y14.5M-1994.
2. CONTROLLING DIMENSION: MILLIMETER
3. DIMENSIONS ARE SHOWN IN MILLIMETERS [INCHES].
4. OUTLINE CONFORMS TO JEDEC OUTLINE MS-012AA.
- ⑤ DIMENSION DOES NOT INCLUDE MOLD PROTRUSIONS. MOLD PROTRUSIONS NOT TO EXCEED 0.15 [0.006].
- ⑥ DIMENSION DOES NOT INCLUDE MOLD PROTRUSIONS. MOLD PROTRUSIONS NOT TO EXCEED 0.25 [0.010].
- ⑦ DIMENSION IS THE LENGTH OF LEAD FOR SOLDERING TO A SUBSTRATE.

**FOOTPRINT**



## SO-8 Part Marking Information

EXAMPLE: THIS IS AN IRF7101 (MOSFET)



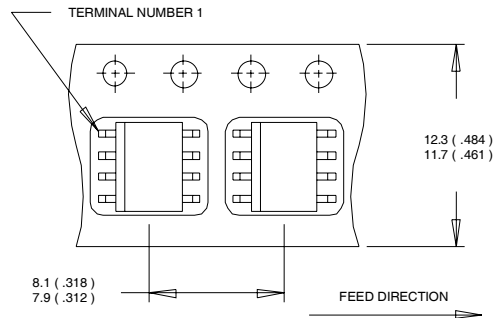
**Note:** For the most current drawing please refer to IR website at: <http://www.irf.com/package/>

# IRF9910PbF

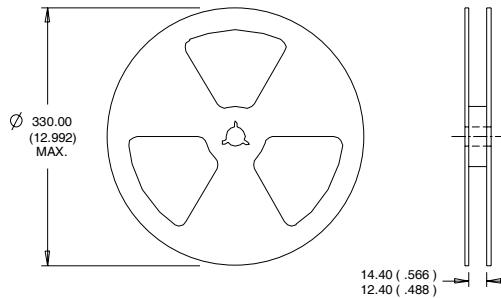
## SO-8 Tape and Reel

International  
**IR** Rectifier

Dimensions are shown in millimeters (inches)



- NOTES:
1. CONTROLLING DIMENSION : MILLIMETER.
  2. ALL DIMENSIONS ARE SHOWN IN MILLIMETERS(INCHES).
  3. OUTLINE CONFORMS TO EIA-481 & EIA-541.



- NOTES:
1. CONTROLLING DIMENSION : MILLIMETER.
  2. OUTLINE CONFORMS TO EIA-481 & EIA-541.

**Note:** For the most current drawing please refer to IR website at: <http://www.irf.com/package/>

### Notes:

- ① Repetitive rating; pulse width limited by max. junction temperature.
- ② Starting  $T_J = 25^\circ\text{C}$ , Q1:  $L = 0.95\text{mH}$   
 $R_G = 25\Omega$ ,  $I_{AS} = 8.3\text{A}$ ; Q2:  $L = 0.54\text{mH}$   
 $R_G = 25\Omega$ ,  $I_{AS} = 9.8\text{A}$ .
- ③ Pulse width  $\leq 400\mu\text{s}$ ; duty cycle  $\leq 2\%$ .
- ④ When mounted on 1 inch square copper board.
- ⑤  $R_\theta$  is measured at  $T_J$  approximately  $90^\circ\text{C}$ .

Data and specifications subject to change without notice.  
This product has been designed and qualified for the Consumer market.  
Qualifications Standards can be found on IR's Web site.

International  
**IR** Rectifier

**IR WORLD HEADQUARTERS:** 233 Kansas St., El Segundo, California 90245, USA Tel: (310) 252-7105  
TAC Fax: (310) 252-7903

Visit us at [www.irf.com](http://www.irf.com) for sales contact information.07/2008

[www.irf.com](http://www.irf.com)