



# IR Emitter and Detector Product Data Sheet

LTE-3279K

Spec No.: DS-50-99-0008

Effective Date: 01/31/2013

Revision: B

**LITE-ON DCC**

**RELEASE**

BNS-OD-FC001/A4

**FEATURES**

- \* SPECIAL FOR HIGH CURRENT AND LOW FORWARD VOLTAGE
- \* HIGH POWER
- \* AVAILABLE FOR PULSE OPERATING
- \* WIDE VIEWING ANGLE
- \* LIGHT BLUE TRANSPARENT COLOR PACKAGE
- \* TIN DIPPING LEADS

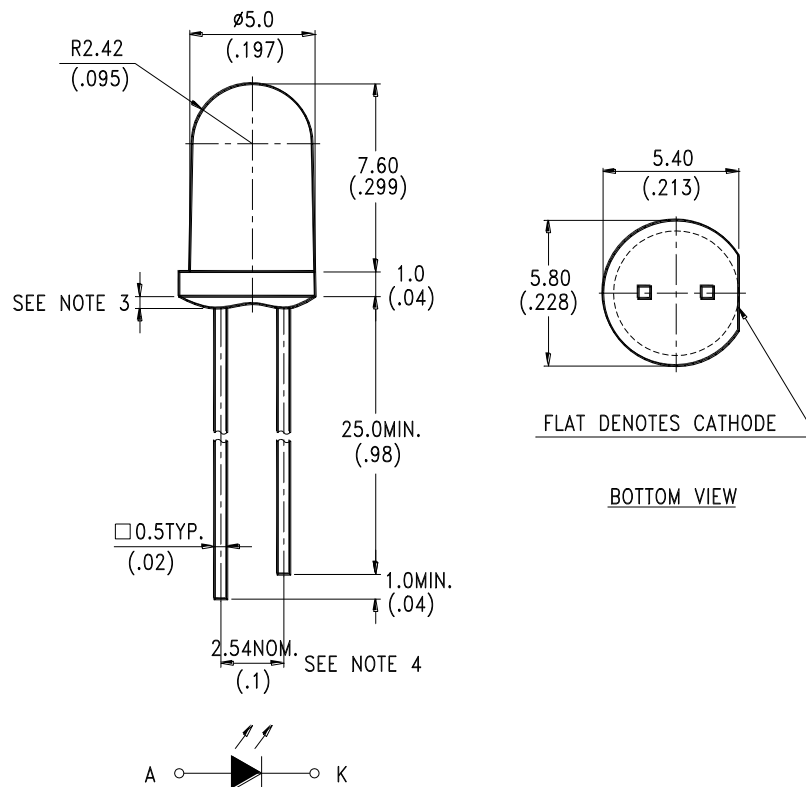
**PACKAGE DIMENSIONS****NOTES:**

1. All dimensions are in millimeters (inches).
2. Tolerance is  $\pm 0.25$ mm(.010") unless otherwise noted.
3. Protruded resin under flange is 1.5mm(.059") max.
4. Lead spacing is measured where the leads emerge from the package.
5. Specifications are subject to change without notice.

**ABSOLUTE MAXIMUM RATINGS AT TA=25°C**

PARAMETER	MAXIMUM RATING	UNIT
Power Dissipation	150	mW
Peak Forward Current (300pps, 10 $\mu$ s pulse)	2	A
Continuous Forward Current	100	mA
Reverse Voltage	5	V
Operating Temperature Range	-40°C to + 85°C	
Storage Temperature Range	-55°C to + 100°C	
Lead Soldering Temperature [1.6mm(.063") From Body]	260°C for 5 Seconds	

**ELECTRICAL OPTICAL CHARACTERISTICS AT TA=25°C**

PARAMETER	SYMBOL	MIN.	TYP.	MAX.	UNIT	TEST CONDITION	Remark
Radiant Intensity	$I_E$	35	50		mW/sr	$I_F = 100mA$	
Peak Emission Wavelength	$\lambda_P$		940		nm	$I_F = 100mA$	
Spectral Line Half-Width	$\Delta \lambda$		50		nm	$I_F = 100mA$	
Forward Voltage	$V_F$		1.4	1.8	V	$I_F = 100Ma$	
Reverse Current	$I_R$			100	$\mu A$	$V_R = 5V$	
Viewing Angle (See FIG.6)	$2\theta_{1/2}$		60		deg.		

## TYPICAL ELECTRICAL / OPTICAL CHARACTERISTICS CURVES

(25°C Ambient Temperature Unless Otherwise Noted)

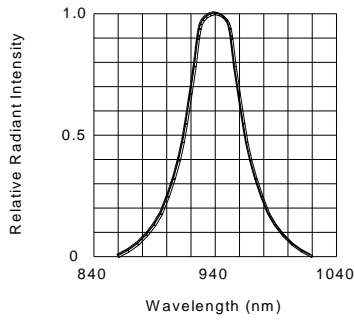

FIG.1 SPECTRAL DISTRIBUTION

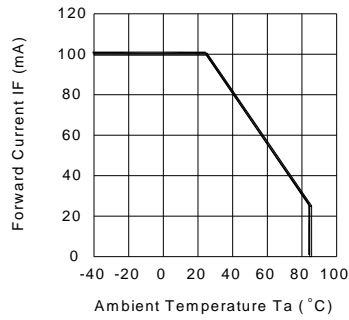

FIG.2 FORWARD CURRENT VS. AMBIENT TEMPERATURE

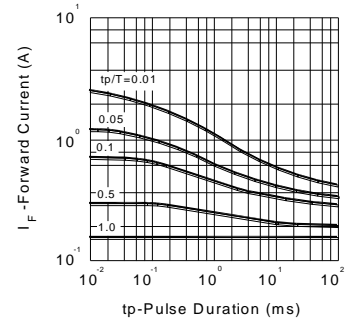

FIG.7 PULSE FORWARD CURRENT VS. PULSE DURATION

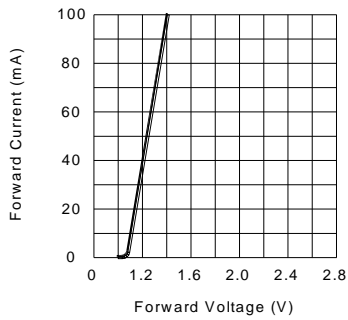

FIG.3 FORWARD CURRENT VS. FORWARD VOLTAGE

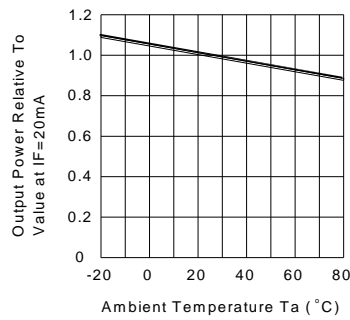

FIG.4 RELATIVE RADIANT INTENSITY VS. AMBIENT TEMPERATURE

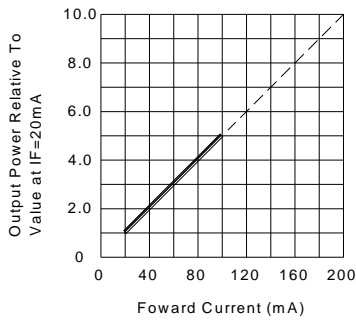

FIG.5 RELATIVE RADIANT INTENSITY VS. FORWARD CURRENT

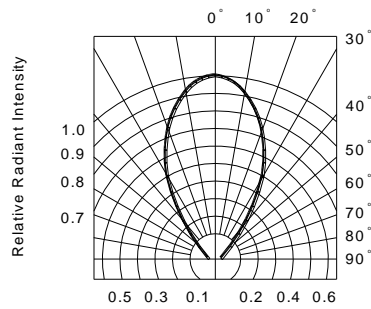

FIG.6 RADIATION DIAGRAM