



Muffin XL - MD48B3 - 032038 - No
 (Family) (Model) (Part #) (In Stock)

Electrical Specifications

Operating Voltage:	48 Volts
Voltage Range:	24 - 56 Volts
Power Supply:	5.8 Watts
Line Current:	0.12 Amps
Locked Rotor Current	0.40 Amps
Nominal Speed:	3100 RPM

Mechanical Specifications

Dimensions:	4.7 x 4.7 x 1.5 in
Weight	21.52 oz
Max Airflow @ 0 in H ₂ O	110.0 CFM
Max Pressure @ 0 CFM	0.278 in H ₂ O
Noise	50.0 dBA



Mechanical Drawing

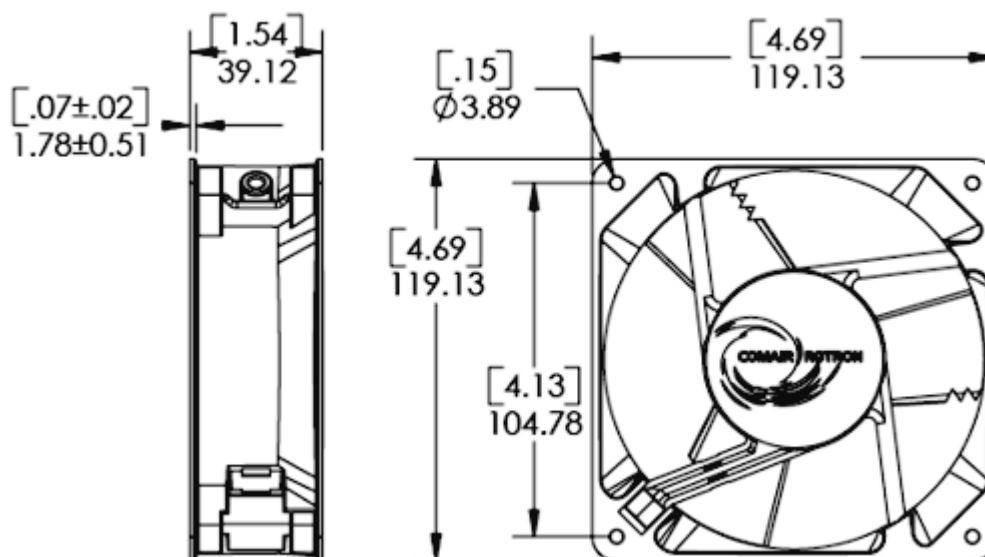

Comair Rotron, Inc.
 Phone: 619.651.2000
 sales@comairrotron.com

Comair Rotron Europe, Ltd.
 Phone: +44.1527.520525
 saleseurope@comairrotron.com

Comair Rotron Fan Company Ltd.
 Phone: +86.21.52260581
 salesasia@comairrotron.com

Print Date: Wednesday, November 10, 2010 at 10:05:53 - DC Fan Datasheet - Web Version 1.0 Rev. B



Fan Performance Curve

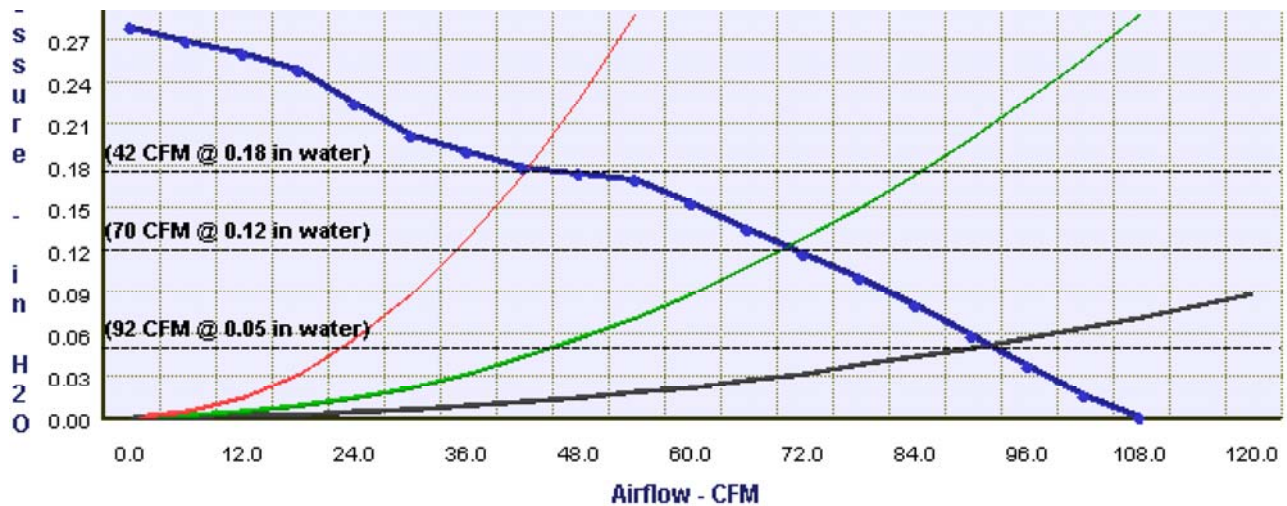

Fan Configuration Options

Muffin XL
(Family)

MD48B3 / 032038
(Model) (Part #)

No
(In Stock)

305 mm [12 inch] Leads
(Features)

Fan Speed: **3100 RPM**
Fan Airflow Direction: **Flow R (CCW Rotation)**

Fan Bearings: **Ball Bearings**
Fan Termination: **Leads**

Fan Monitoring Options: **No Fan Monitoring Options Selected**

Fan Speed Control Option: **No ThermaPro-V Fan Speed Control Options Selected**

Environmental Protection Options: **No Enviroshield Options Selected**

Comair Rotron, Inc.
Phone: 619.651.2000
sales@comairrotron.com

Comair Rotron Europe, Ltd.
Phone: +44.1527.520525
saleseurope@comairrotron.com

Comair Rotron Fan Company Ltd.
Phone: +86.21.52260581
salesasia@comairrotron.com

Print Date: Wednesday, November 10, 2010 at 10:05:53 - DC Fan Datasheet - Web Version 1.0 Rev. B



Accessories (Click on part number for detailed drawing.)

571064
Plug and Cord



550113
Mounting Clip

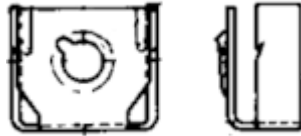

551590
Filter Assembly
Mounting Bracket Filter Frame
Filter Element
Fan Venturi Edge

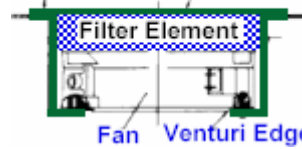

554148
Filter Guard Assembly

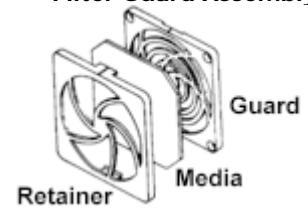

552934
Finger Guard



476042
Finger Guard

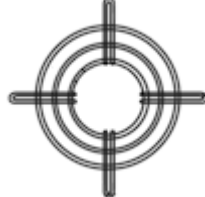

550481
Finger Guard

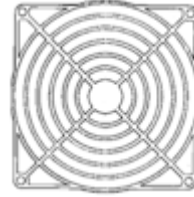

551147
Finger Guard

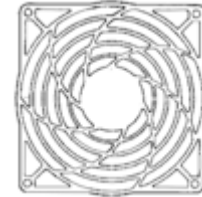

Comair Rotron, Inc.
Phone: 619.651.2000
sales@comairrotron.com

Comair Rotron Europe, Ltd.
Phone: +44.1527.520525
saleseurope@comairrotron.com

Comair Rotron Fan Company Ltd.
Phone: +86.21.52260581
salesasia@comairrotron.com

Print Date: Wednesday, November 10, 2010 at 10:05:53 - DC Fan Datasheet - Web Version 1.0 Rev. B