

Dual IGBTMOD™ U-Series Module 800 Amperes/600 Volts

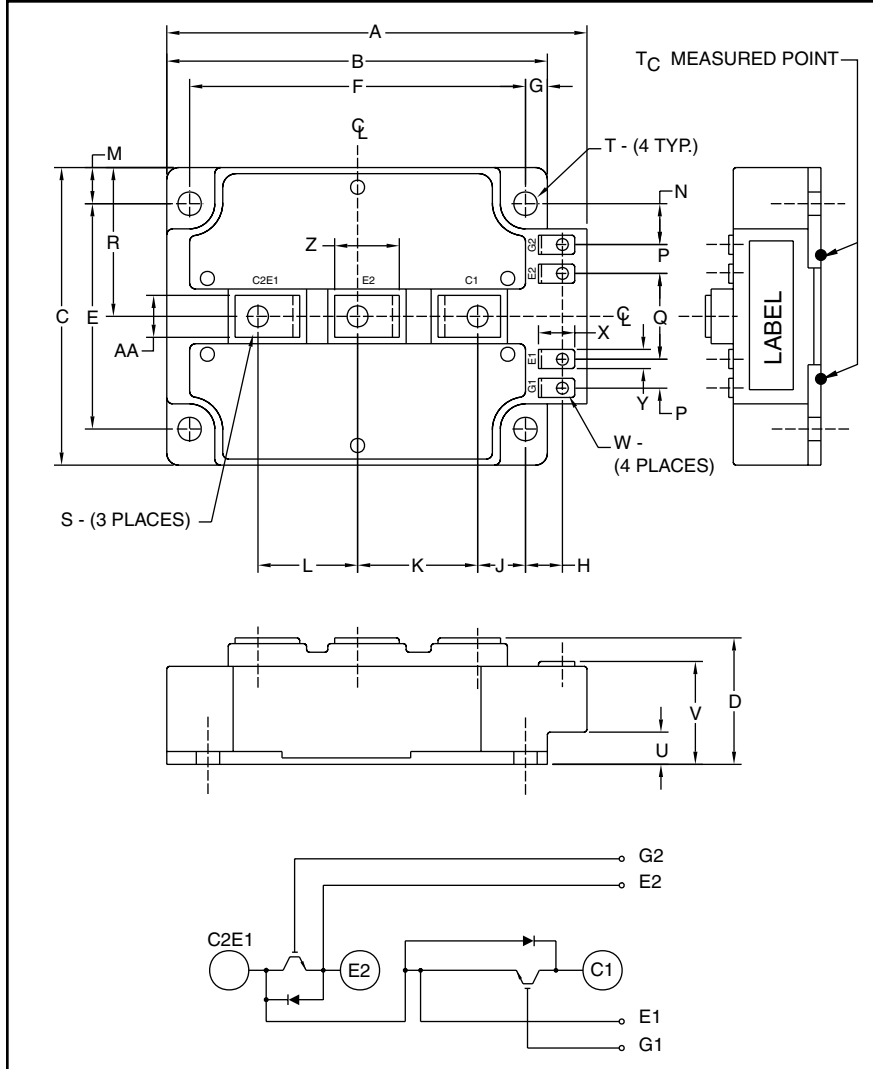

Outline Drawing and Circuit Diagram

Dimensions	Inches	Millimeters
A	5.51	140.0
B	5.12	130.0
C	5.12	130.0
D	1.38	35.0
E	4.33	110.0
F	4.33	110.0
G	0.39	10.0
H	0.45	11.5
J	0.54	13.8
K	1.72	43.8
L	1.42	36.0
M	0.39	10.0
N	0.80	20.4

Dimensions	Inches	Millimeters
P	0.57	14.5
Q	1.57	40.0
R	2.56	65.0
S	M8	M8
T	0.26 Dia.	6.5 Dia.
S	0.32	8.0
V	0.97	24.5
W	M4	M4
X	0.59	15.0
Y	0.35	9.0
Z	1.02	26.0
AA	0.79	20.0



Description:

Powerex IGBTMOD™ Modules are designed for use in switching applications. Each module consists of two IGBT Transistors in a half-bridge configuration with each transistor having a reverse-connected super-fast recovery free-wheel diode. All components and interconnects are isolated from the heat sinking baseplate, offering simplified system assembly and thermal management.

Features:

- Low Drive Power
- Low $V_{CE(sat)}$
- Discrete Super-Fast Recovery Free-Wheel Diode
- Isolated Baseplate for Easy Heat Sinking

Applications:

- AC Motor Control
- Motion/Servo Control
- UPS
- Welding Power Supplies
- Laser Power Supplies

Ordering Information:

Example: Select the complete module number you desire from the table - i.e. CM800DU-12H is a 600V (V_{CES}), 800 Ampere Dual IGBTMOD™ Power Module.

Type	Current Rating Amperes	V_{CES} Volts (x 50)
CM	800	12

CM800DU-12H
Dual IGBTMOD™ U-Series Module
 800 Amperes/600 Volts

Absolute Maximum Ratings, $T_j = 25\text{ °C}$ unless otherwise specified

Ratings	Symbol	CM800DU-12H	Units
Junction Temperature	T_j	-40 to 150	°C
Storage Temperature	T_{stg}	-40 to 125	°C
Collector-Emitter Voltage (G-E SHORT)	V_{CES}	600	Volts
Gate-Emitter Voltage (C-E SHORT)	V_{GES}	±20	Volts
Collector Current ($T_c = 25\text{ °C}$)	I_C	800	Amperes
Peak Collector Current	I_{CM}	1600*	Amperes
Emitter Current** ($T_c = 25\text{ °C}$)	I_E	800	Amperes
Peak Emitter Current**	I_{EM}	1600*	Amperes
Maximum Collector Dissipation ($T_c = 25\text{ °C}$, $T_j \leq 150\text{ °C}$)	P_c	1500	Watts
Mounting Torque, M8 Main Terminal	–	95	in-lb
Mounting Torque, M6 Mounting	–	40	in-lb
G(E) Terminal, M4	–	15	in-lb
Weight	–	310	Grams
Isolation Voltage (Main Terminal to Baseplate, AC 1 min.)	V_{iso}	2500	Volts

* Pulse width and repetition rate should be such that the device junction temperature (T_j) does not exceed $T_{j(max)}$ rating.

**Represents characteristics of the anti-parallel, emitter-to-collector free-wheel diode (FWDi).

Static Electrical Characteristics, $T_j = 25\text{ °C}$ unless otherwise specified

Characteristics	Symbol	Test Conditions	Min.	Typ.	Max.	Units
Collector-Cutoff Current	I_{CES}	$V_{CE} = V_{CES}$, $V_{GE} = 0V$	–	–	2	mA
Gate Leakage Current	I_{GES}	$V_{GE} = V_{GES}$, $V_{CE} = 0V$	–	–	0.5	µA
Gate-Emitter Threshold Voltage	$V_{GE(th)}$	$I_C = 80mA$, $V_{CE} = 10V$	4.5	6	7.5	Volts
Collector-Emitter Saturation Voltage	$V_{CE(sat)}$	$I_C = 800A$, $V_{GE} = 15V$, $T_j = 25\text{ °C}$	–	2.5	3.15	Volts
		$I_C = 800A$, $V_{GE} = 15V$, $T_j = 125\text{ °C}$	–	2.75	–	Volts
Total Gate Charge	Q_G	$V_{CC} = 300V$, $I_C = 800A$, $V_{GE} = 15V$	–	1600	–	nC
Emitter-Collector Voltage**	V_{EC}	$I_E = 800A$, $V_{GE} = 0V$	–	–	2.6	Volts

**Represents characteristics of the anti-parallel, emitter-to-collector free-wheel diode (FWDi).

Dynamic Electrical Characteristics, $T_j = 25\text{ °C}$ unless otherwise specified

Characteristics	Symbol	Test Conditions	Min.	Typ.	Max.	Units
Input Capacitance	C_{ies}		–	–	70.4	nf
Output Capacitance	C_{oes}	$V_{CE} = 10V$, $V_{GE} = 0V$	–	–	38.4	nf
Reverse Transfer Capacitance	C_{res}		–	–	10.4	nf
Resistive	Turn-on Delay Time	$V_{CC} = 300V$, $I_C = 800A$, $V_{GE1} = V_{GE2} = 15V$,	–	–	400	ns
Load	Rise Time		t_r	–	–	2000
Switch	Turn-off Delay Time	$R_G = 3.1\Omega$, Resistive	–	–	500	ns
Times	Fall Time		t_f	–	–	300
Diode Reverse Recovery Time**	t_{rr}	$I_E = 800A$, $di_E/dt = -1600A/\mu s$	–	–	160	ns
Diode Reverse Recovery Charge**	Q_{rr}	$I_E = 800A$, $di_E/dt = -1600A/\mu s$	–	1.92	–	µC

**Represents characteristics of the anti-parallel, emitter-to-collector free-wheel diode (FWDi).

Thermal and Mechanical Characteristics, $T_j = 25\text{ °C}$ unless otherwise specified

Characteristics	Symbol	Test Conditions	Min.	Typ.	Max.	Units
Thermal Resistance, Junction to Case	$R_{th(j-c)Q}$	Per IGBT 1/2 Module	–	–	0.083	°C/W
Thermal Resistance, Junction to Case	$R_{th(j-c)R}$	Per FWDi 1/2 Module	–	–	0.13	°C/W
Contact Thermal Resistance	$R_{th(c-f)}$	Per Module, Thermal Grease Applied	–	0.010	–	°C/W

CM800DU-12H
Dual IGBTMOD™ U-Series Module
 800 Amperes/600 Volts

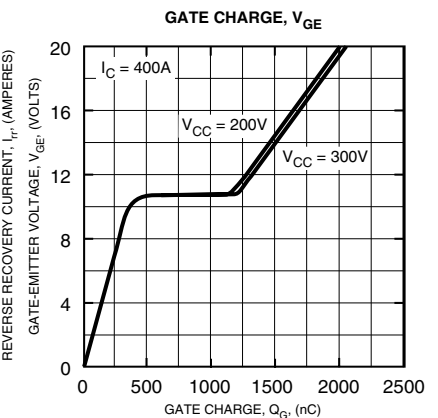
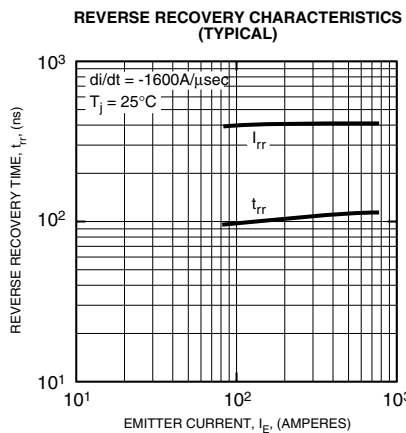
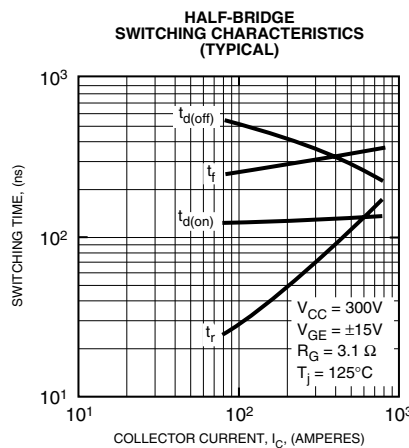
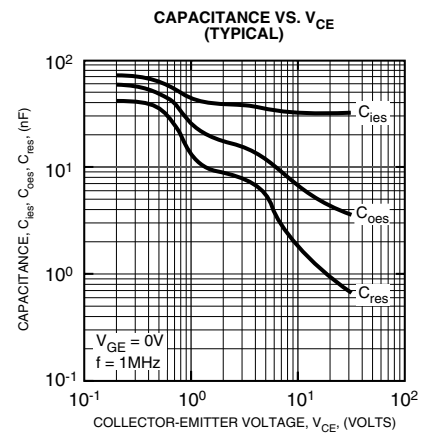
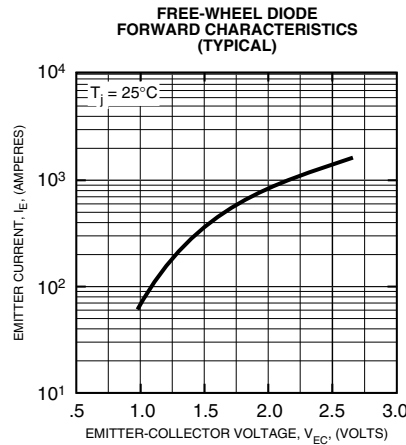
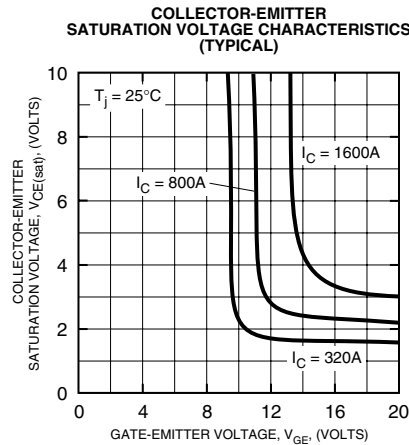
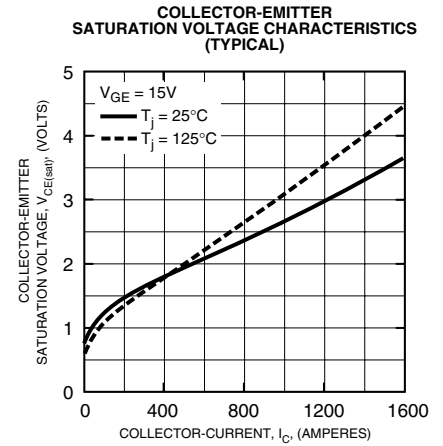
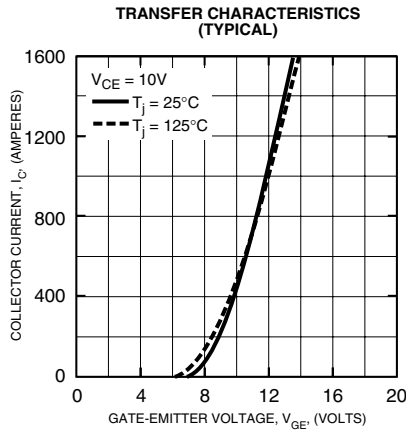
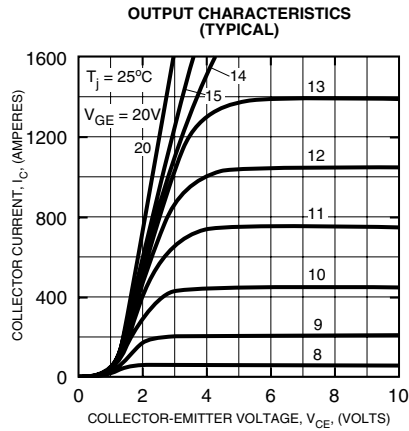



Powerex, Inc., 200 E. Hillis Street, Youngwood, Pennsylvania 15697-1800 (724) 925-7272

CM800DU-12H
Dual IGBTMOD™ U-Series Module
800 Amperes/600 Volts

